

GaAs IC 5 Bit Digital Attenuator

0.5 dB LSB DC–2 GHz



AA280-25
(Previously AD280-25)*

Features

- Attenuation 0.5 dB Steps to 15.5 dB with High Accuracy
- Low DC Power Consumption
- Low Cost SOIC-16 Plastic Package

Description

The AA280-25 is a 5 bit, GaAs IC FET digital attenuator in a low cost SOIC-16 package. This attenuator has an LSB of 0.5 dB and a total attenuation of 15.5 dB. The AA280-25 is particularly suited where high attenuation accuracy, low insertion loss and low intermodulation products are required. Typical applications include cellular radio, wireless data, wireless local loop and other gain level control circuits.

SOIC-16

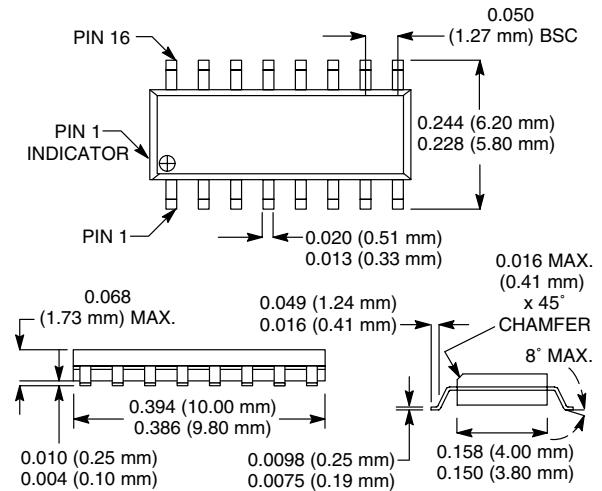

Electrical Specifications at -40°C to +85°C (0, -5 V)

Parameter ¹	Condition	Frequency ²	Min.	Typ.	Max.	Unit
Insertion Loss ³		DC–0.5 GHz		1.1	1.3	dB
		DC–1.0 GHz		1.4	1.7	dB
		DC–2.0 GHz		1.7	2.0	dB
Attenuation Range				15.5		dB
Attenuation Accuracy ³		DC–1.0 GHz	± (0.2 + 3% of Attenuation Setting in dB)			dB
		DC–2.0 GHz	± (0.4 + 3% of Attenuation Setting in dB)			dB
VSWR (I/O) ⁴		DC–2.0 GHz		1.4:1	1.8:1	
Switching Characteristics ⁵	Rise, Fall (10/90% or 90%/10% RF) On, Off (50% CTL to 90%/10% RF) Video Feedthru			15		nS
				25		nS
				25		mV
Input Power for 1 dB Compression		0.5–2.0 GHz 0.05 GHz	+24 +17	+29 +22		dBm dBm
Intermodulation Intercept Point (IP3)	For Two-tone Input Power +5 dBm	0.5–2.0 GHz 0.05 GHz	+44 +35	+50 +40		dBm dBm
Control Voltages	V _{Low} = 0 to 0.2 V @ 20 µA Max. V _{High} = -5 V @ 300 µA Max.					

1. All measurements made in a 50 Ω system, unless otherwise specified.
2. DC = 300 kHz.
3. Attenuation referenced to insertion loss.

4. Input/Output
5. Video feedthru measured with 1 ns risetime pulse and 500 MHz bandwidth.

*Due to conflict with another company's product numbering system, Skyworks' attenuator products starting with the letters "AD" are being changed to "AA".

Typical Performance Data (0, -5 V)

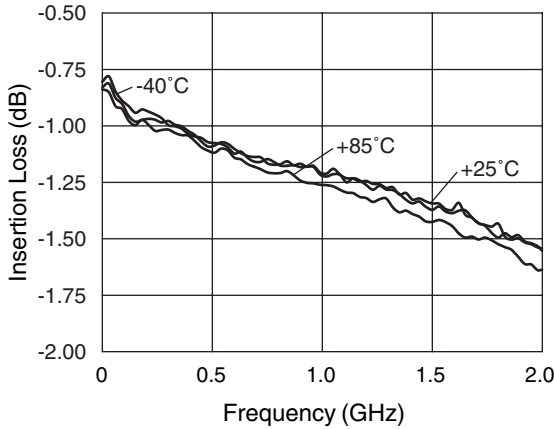

Insertion Loss vs. Frequency

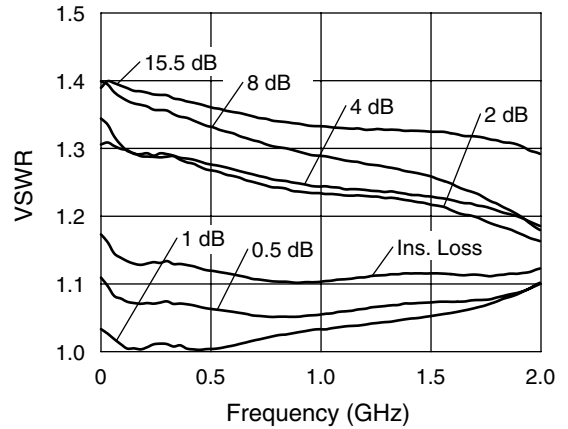

VSWR vs. Frequency (25°C)

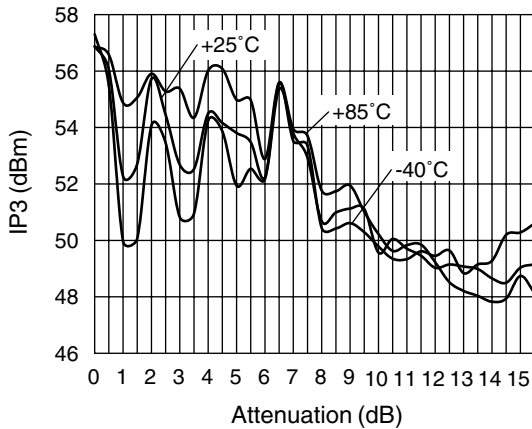

IP3 vs. Attenuation and Temperature

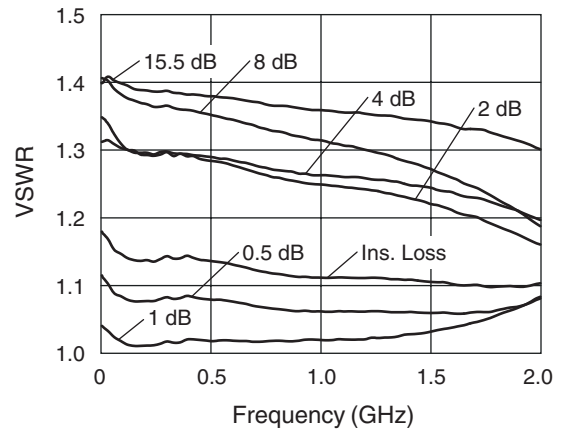

VSWR vs. Frequency (85°C)

Compression Point vs. Attenuation, Voltage, and Temperature

Attenuation State	Control Voltage (V)	Input Power @ 1 dB Compression		
		+25°C (dBm)	+85°C (dBm)	-40°C (dBm)
Ins. Loss	-5	28.30	28.10	29.10
0.5 dB	-5	28.50	28.30	29.40
1.0 dB	-5	28.70	28.70	29.60
2.0 dB	-5	28.40	28.30	29.10
4.0 dB	-5	32.90	32.90	33.90
8.0 dB	-5	36.80	36.80	36.80
15.5 dB	-5	32.70	32.10	32.80

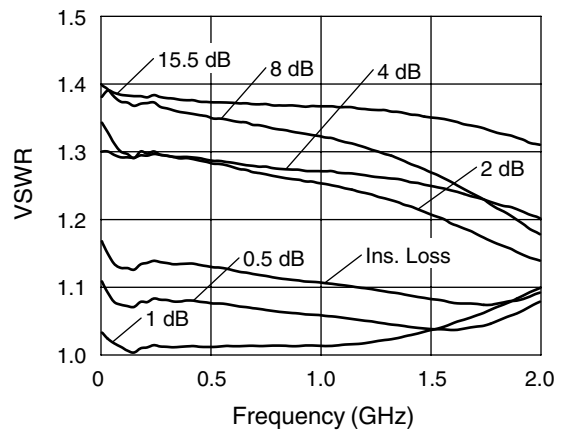

VSWR vs. Frequency (-40°C)

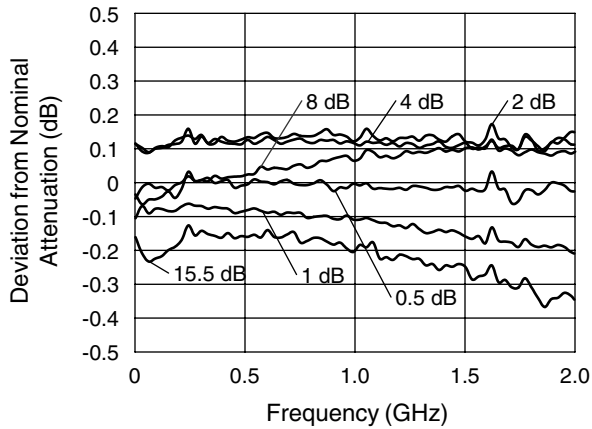

Attenuation Accuracy vs. Frequency (25°C)

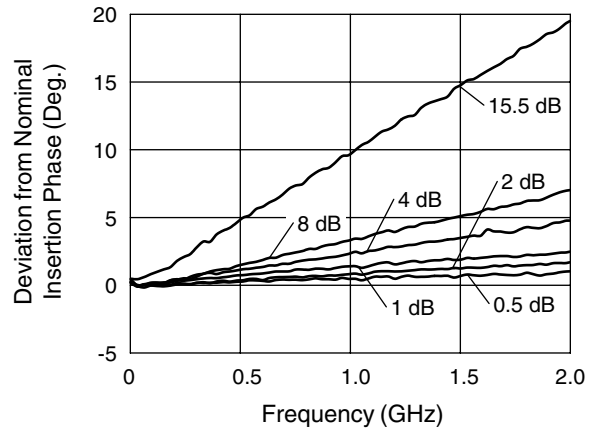

Attenuation Phase Accuracy vs. Frequency (25°C)

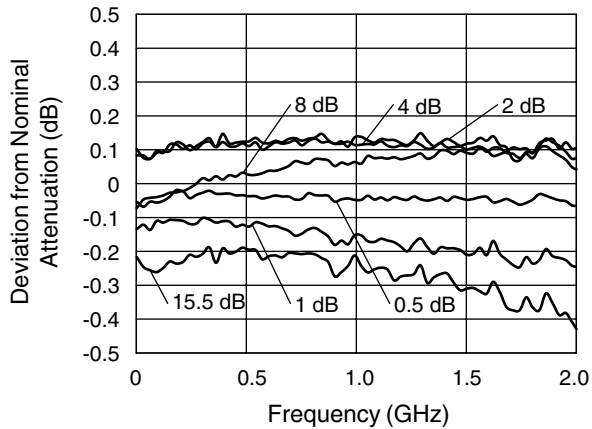

Attenuation Accuracy vs. Frequency (85°C)

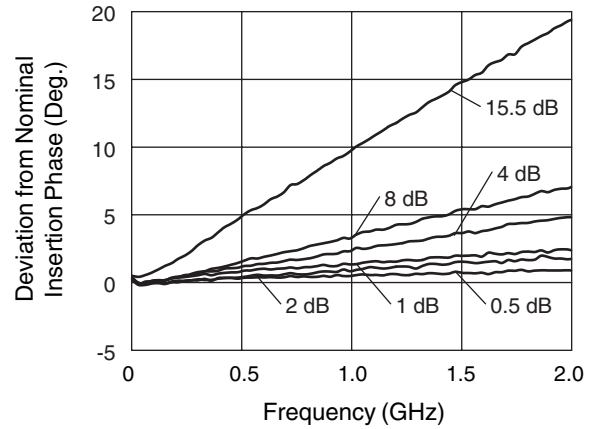

Attenuation Phase Accuracy vs. Frequency (85°C)

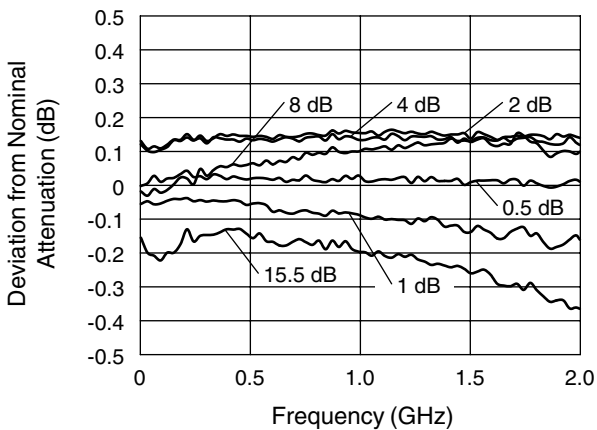

Attenuation Accuracy vs. Frequency (-40°C)

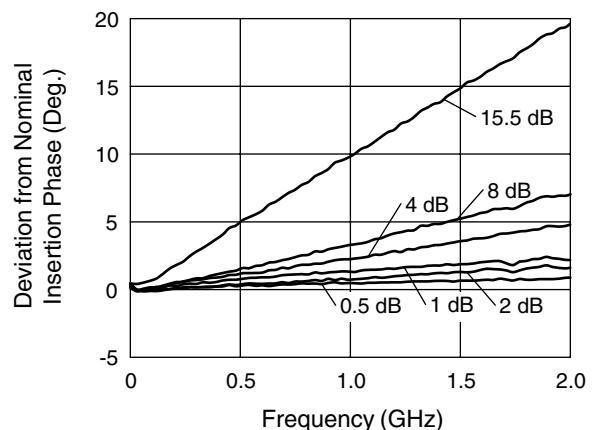

Attenuation Phase Accuracy vs. Frequency (-40°C)

Typical Performance Data (0, -3 V)

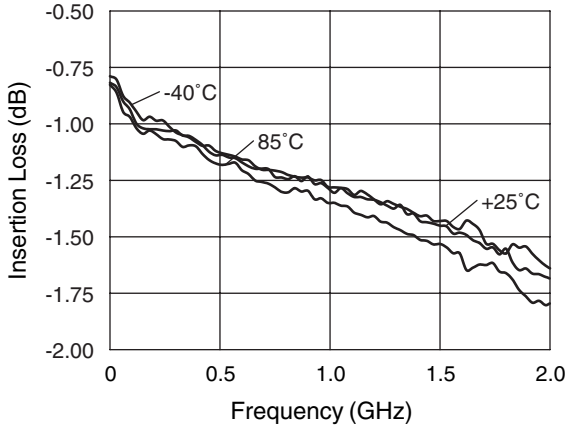

Insertion Loss vs. Frequency

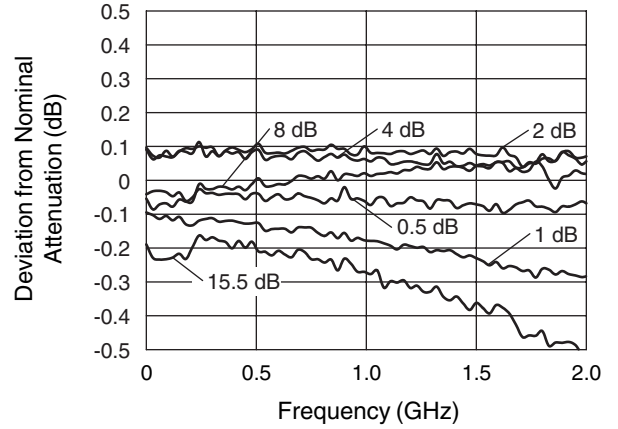

Attenuation Accuracy vs. Frequency (25°C)

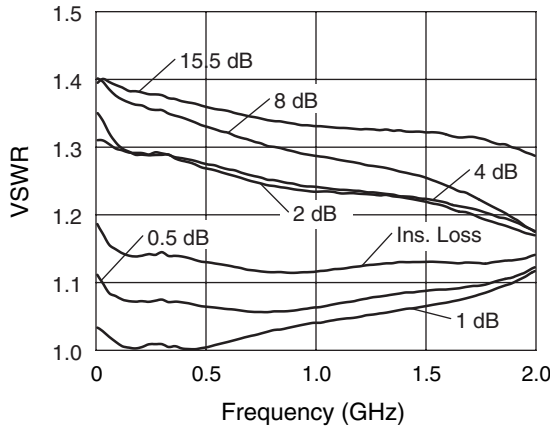

VSWR vs. Frequency (25°C)

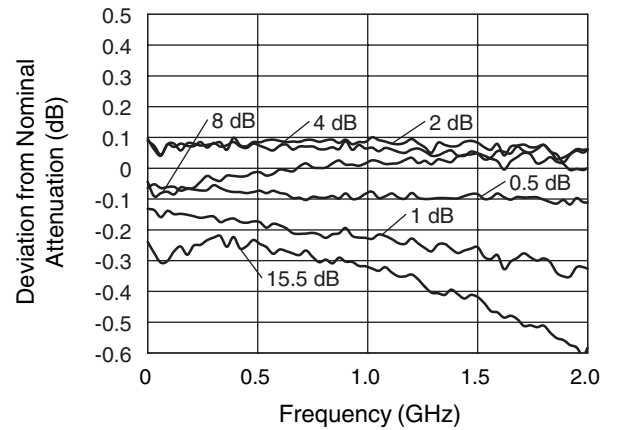

Attenuation Accuracy vs. Frequency (85°C)

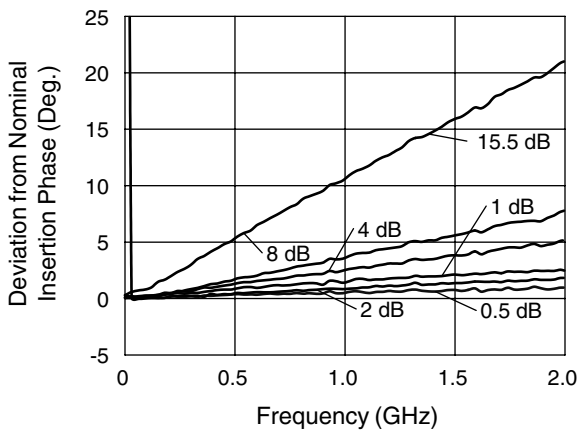

Attenuation Phase Accuracy vs. Frequency (25°C)

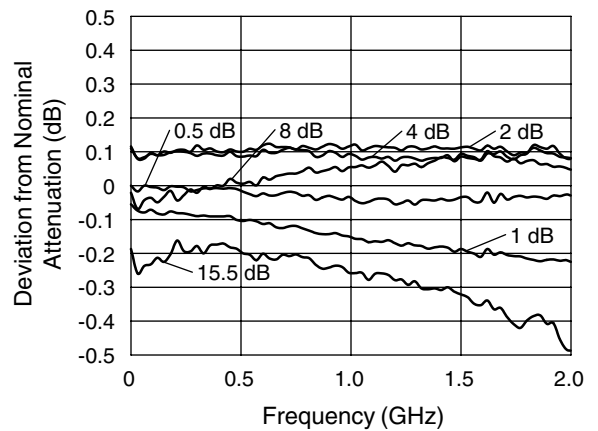

Attenuation Accuracy vs. Frequency (-40°C)

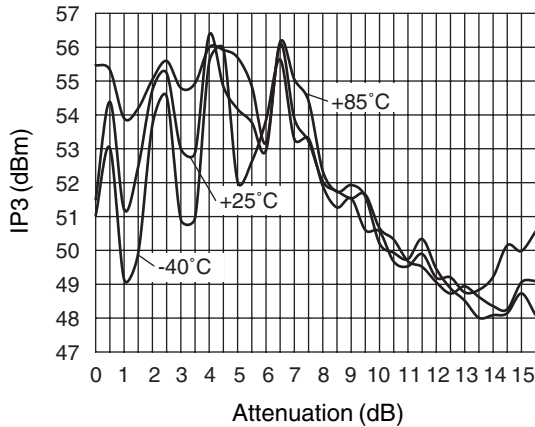

IP3 vs. Attenuation and Temperature

Compression Point vs. Attenuation, Voltage, and Temperature

Attenuation State	Control Voltage (V)	Input Power @ 1 dB Compression		
		+25°C (dBm)	+85°C (dBm)	-40°C (dBm)
Ins. Loss	-3	22.70	23.30	24.20
0.5 dB	-3	23.50	24.20	25.10
1.0 dB	-3	24.60	25.00	25.90
2.0 dB	-3	22.90	23.40	24.30
4.0 dB	-3	31.60	31.80	33.10
8.0 dB	-3	31.00	28.70	26.40
15.5 dB	-3	25.00	24.40	25.00

Pin Out

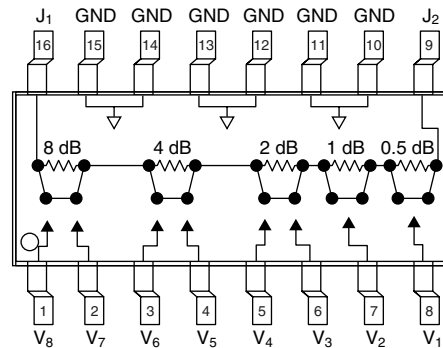

Truth Table

V ₁	V ₂	V ₃	V ₄	V ₅	V ₆	V ₇	V ₈	Attenuation J ₁ -J ₂
0.5 dB Bit	1 dB Bit	2 dB Bit	4 dB Bit	8 dB Bit				
-5	-5	-5	0	-5	0	-5	0	Reference I.L.
0	-5	-5	0	-5	0	-5	0	0.5 dB
-5	0	-5	0	-5	0	-5	0	1 dB
-5	-5	0	-5	-5	0	-5	0	2 dB
-5	-5	-5	0	0	-5	-5	0	4 dB
-5	-5	-5	0	-5	0	0	-5	8 dB
0	0	0	-5	0	-5	0	-5	15.5 dB Max. Atten.

Absolute Maximum Ratings

Characteristic	Value
RF Input Power	2.0 W > 500 MHz 0/-8 V 0.5 W > 50 MHz 0/-8 V
Control Voltage	+0.2 V, -8 V
Operating Temperature	-40°C to +85°C
Storage Temperature	-65°C to +150°C
Θ _{JC}	85°C/W

Note: Exceeding these ratings may cause irreversible damage.

This datasheet has been download from:

www.datasheetcatalog.com

Datasheets for electronics components.