

TRIACS

DESCRIPTION

Passivated triacs in a plastic envelope, intended for use in applications requiring high bidirectional transient and blocking voltage capability and high thermal cycling performance. Typical applications include motor control, industrial and domestic lighting, heating and static switching.

SYMBOL

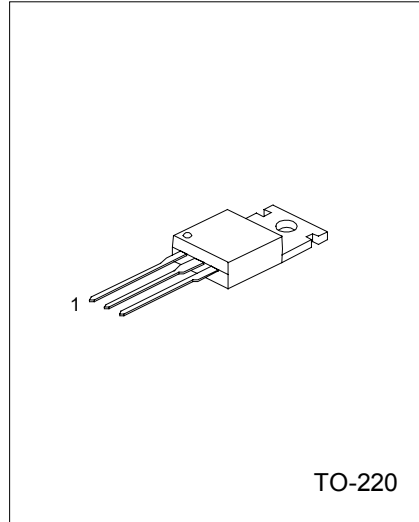
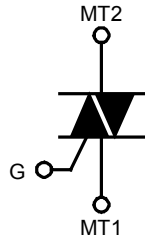

1:MT1 2:MT2 3:GATE

ABSOLUTE MAXIMUM RATINGS (Tj=25°C)

PARAMETER	SYMBOL	RATING	UNIT
Repetitive Peak Off State Voltage UT138F/G-5 UT138F/G-6 UT138F/G-8	VDRM	500* 600* 800	V
RMS On-state Current (Full sine wave, Tmb≤99°C)	IT(RMS)	12	A
Non-repetitive Peak. On-State Current (Full sine wave, Tj=25°C prior to surge) t=20ms t=16.7ms	ITSM	95 105	A
I ² t For Fusing (t=10ms)	I ² t	45	A ² s
Repetitive Rate of Rise of On-state Current after Triggering (ITM=20A, IG=0.2A, dIG/dt=0.2A/μs) T2+ G+ T2+ G- T2- G- T2- G+	dI _T /dt	50 50 50 10	A/μs
Peak Gate Voltage	VGM	5	V
Peak Gate Current	IGM	2	A
Peak Gate Power	PGM	5	W
Average Gate Power (Over any 20ms period)	PG(AV)	0.5	W
Operating Junction Temperature	Tj	125	°C
Storage Temperature	Tstg	-40~150	°C

*Although not recommended, off-state voltages up to 800V may be applied without damage, but the triac may switch to the on-state. The rate of rise of current should not exceed 15A/μs.

THERMAL RESISTANCES

PARAMETER	SYMBOL	MIN	TYP	MAX	UNIT
Thermal Resistance, Junction to Mounting Base Full cycle	Rthj-mb			1.5	K/W
Half cycle				2.0	
Thermal Resistance, Junction to Ambient In free air	Rthj-a		60		K/W

STATIC CHARACTERISTICS (Tj=25°C, unless otherwise specified)

PARAMETER	SYMBOL	CONDITIONS	MIN	TYP	MAX		UNIT
					UT138F	UT138G	
Gate trigger current	IGT	V _D =12V, I _T =0.1A					mA
		T2+ G+		5	25	50	
		T2+ G-		8	25	50	
		T2- G-		10	25	50	
		T2- G+		22	70	100	
Latching current	IL	V _D =12V, I _{GT} =0.1A					mA
		T2+ G+		7	40	60	
		T2+ G-		20	60	90	
		T2- G-		8	40	60	
		T2- G+		10	60	90	
Holding current	I _H	V _D = 12 V, I _{GT} = 0.1 A		6	30	60	mA
On-state voltage	V _T	I _T =15A		1.4	1.65		V
Gate trigger voltage	V _{GT}	V _D =12V, I _T =0.1A		0.7	1.5		V
		V _D =400V, I _T =0.1A, T _J =125°C	0.25	0.4			V
Off-state leakage current	I _D	V _D =V _{DRM(max)} , T _J =125°C		0.1	0.5		mA

DYNAMIC CHARACTERISTICS (Tj=25°C, unless otherwise specified)

PARAMETER	SYMBOL	CONDITIONS	MIN		TYP	MAX	UNIT
			UT138F	UT138G			
Critical rate of rise of Off-state voltage	dV _D /dt	V _{DM} = 67% V _{DRM(max)} , T _J =125°C; exponential waveform, gate open circuit	50	200	250		V/μs
Critical rate of change of Commutating voltage	dV _{com} /dt	V _{DM} =400V, T _J =95°C, I _{T(RMS)} =12A, dI _{com} /dt =5.4A/ms, gate open circuit		10	20		V/μs
Gate controlled turn-on time	t _{gt}	I _{TM} = 16 A, V _D = V _{DRM(max)} , I _G =0.1A, dI _G /dt=5A/μs			2		μs

TYPICAL CHARACTERISTICS

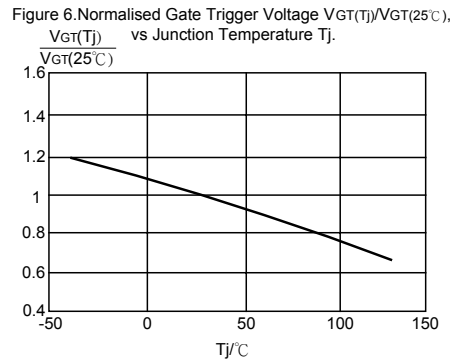
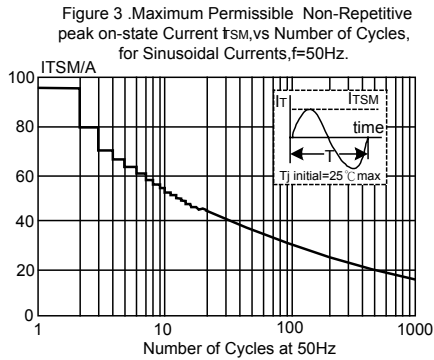
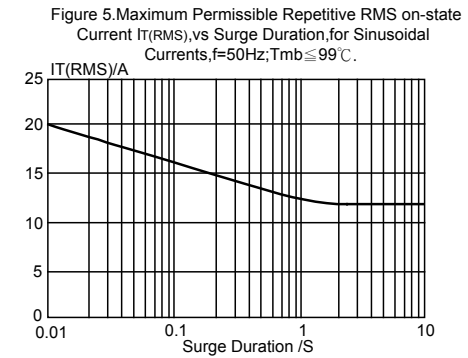
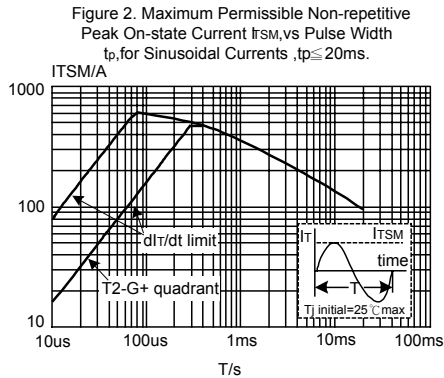
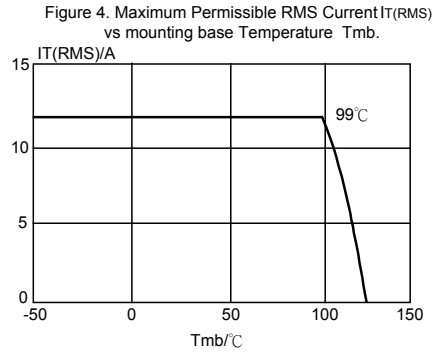
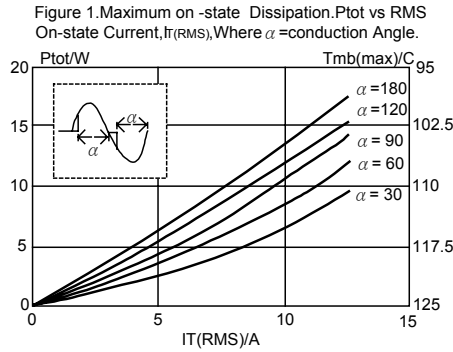

Figure 7. Normalised Gate Trigger Current $I_{GT}(T_j)/I_{GT}(25^\circ\text{C})$, vs Junction Temperature T_j .

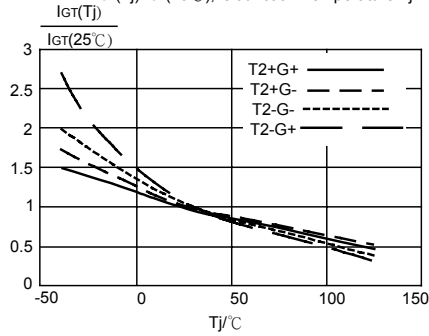

Figure 8. Normalised Latching Current $I_L(T_j)/I_L(25^\circ\text{C})$, vs Junction Temperature T_j .

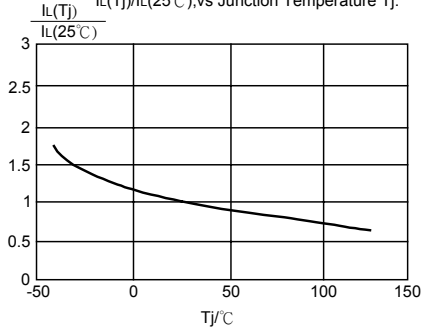

Figure 9. Normalised Holding Current $I_H(T_j)/I_H(25^\circ\text{C})$, vs Junction Temperature T_j .

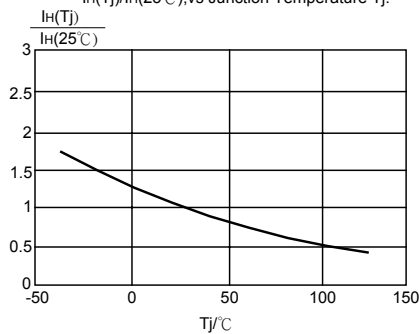

Figure 10. Typical and Maximum On-state Characteristic.

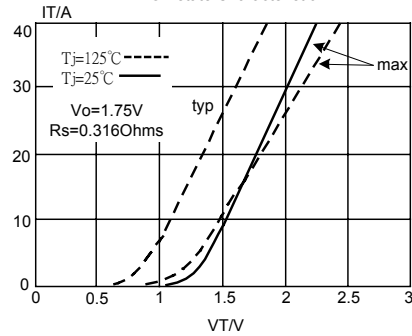

Figure 11. Transient Thermal Impedance $Z_{th\ j-mb}$, vs Pulse Width t_p .

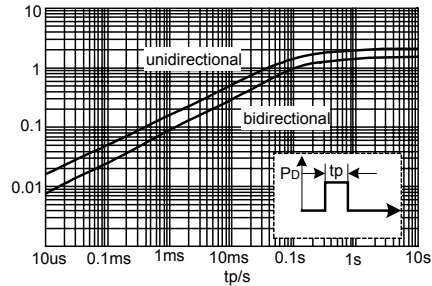
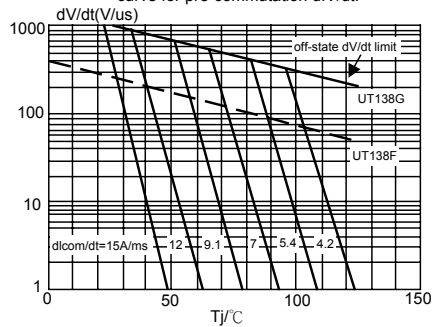

Figure 12. Typical commutation dV/dt vs junction temperature, parameter commutation dI/dt . The triac should commutate when the dV/dt is below the value on the appropriate curve for pre-commutation dI/dt .



UTC assumes no responsibility for equipment failures that result from using products at values that exceed, even momentarily, rated values (such as maximum ratings, operating condition ranges, or other parameters) listed in products specifications of any and all UTC products described or contained herein. UTC products are not designed for use in life support appliances, devices or systems where malfunction of these products can be reasonably expected to result in personal injury. Reproduction in whole or in part is prohibited without the prior written consent of the copyright owner. The information presented in this document does not form part of any quotation or contract, is believed to be accurate and reliable and may be changed without notice.