



TL062

LINEAR INTEGRATED CIRCUIT

LOW POWER DUAL J-FET OPERATIONAL AMPLIFIER

DESCRIPTION

The UTC **TL062** is a high speed J-FET input dual operational amplifier. It incorporates well matched, high voltage J-FET and bipolar transistors in a monolithic integrated circuit. The device features high slew rates, low input bias and offset currents, and low offset voltage temperature coefficient.

FEATURES

- * Very low power consumption
- * Wide common-mode (up to V_{CC+}) and differential voltage range
- * Low input bias and offset current
- * Output short-circuit protection
- * High input impedance J-FET input stage
- * Internal frequency compensation
- * Latch up free operation
- * Typical supply current: 200 μ A

ORDERING INFORMATION

Ordering Number		Package	Packing
Normal	Lead Free Plating		
TL062-D08-T	TL062L-D08-T	DIP-8	Tube
TL062-S08-R	TL062L-S08-R	SOP-8	Tape Reel
TL062-S08-T	TL062L-S08-T	SOP-8	Tube

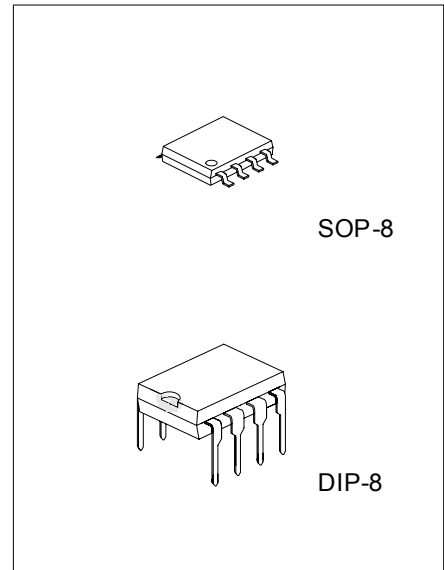

*Pb-free plating product number: TL062L

<p>TL062L-D08-T</p> <p>(1)Packing Type (2)Package Type (3)Lead Plating</p>	<p>(1) T: Tube, R: Tape Reel (2) D08: DIP-8, S08: SOP-8 (3) L: Lead Free Plating, Blank: Pb/Sn</p>
--	--

■ PIN CONFIGURATIONS

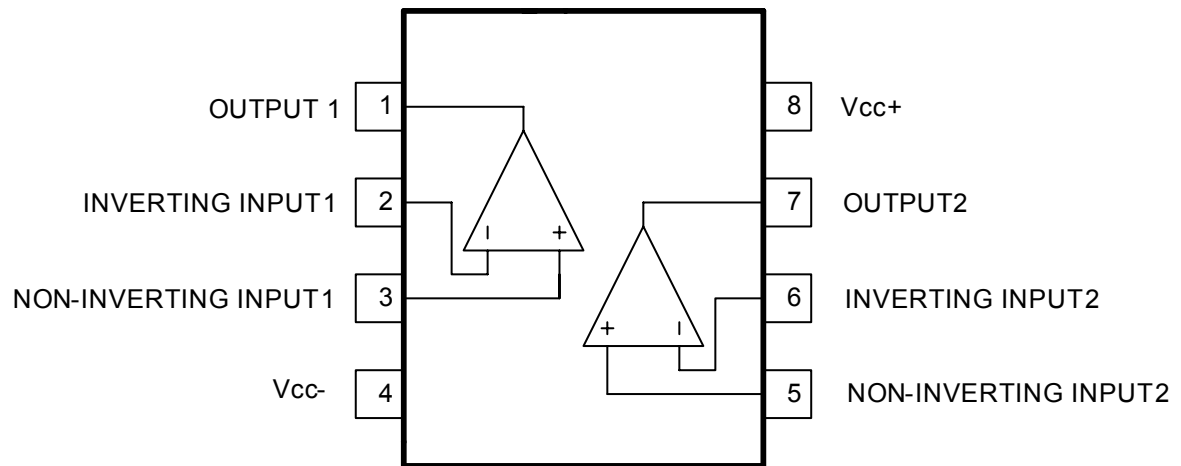

■ BLOCK DIAGRAM

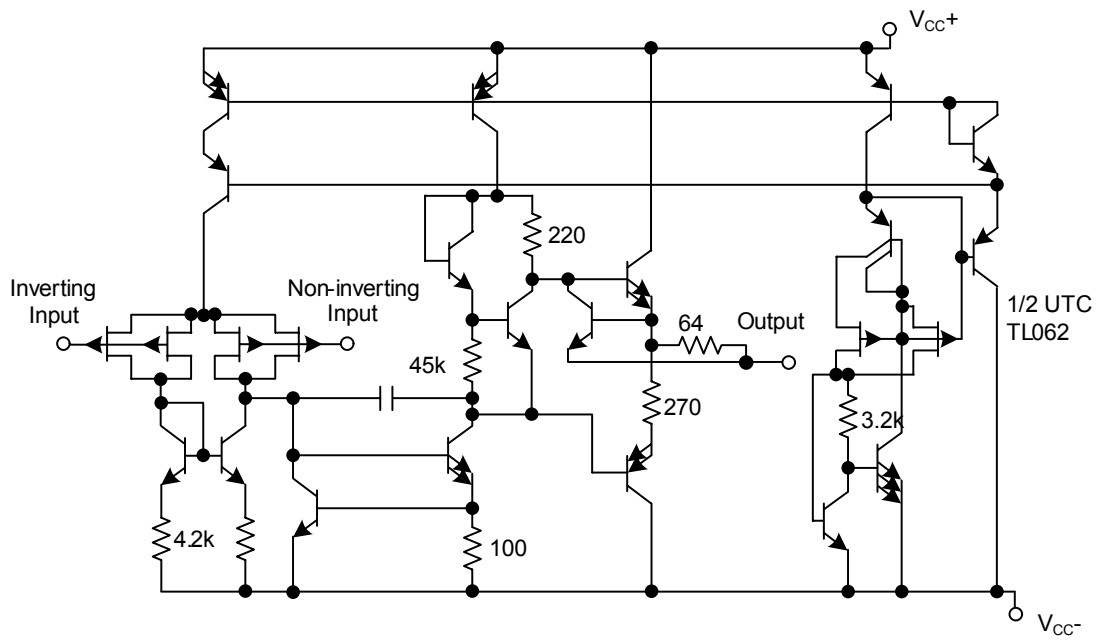

■ ABSOLUTE MAXIMUM RATINGS (Ta=25°C)

PARAMETER	SYMBOL	RATINGS	UNIT
Supply Voltage (note 1)	V _{CC}	±18	V
Input Voltage (note 2)	V _{IN}	±15	V
Differential Input Voltage (note 3)	V _{I(DIFF)}	±30	V
Power Dissipation	P _D	680	mW
Output Short-Circuit Duration (Note 4)		Infinite	
Operating Free Air Temperature	T _{OPR}	0 ~ +70	°C
Storage Temperature	T _{STG}	-65 ~ +150	°C

Notes: 1. All voltage values, except differential voltage, are with respect to the zero reference level (ground) of the supply voltages where the zero reference level is the midpoint between V_{CC-} and V_{CC+}.

- The magnitude of the input voltage must never exceed the magnitude of the supply voltage or 15 volts, whichever is less.
- Differential voltages are at the non-inverting input terminal with respect to the inverting input terminal.
- The output may be shorted to ground or to either supply. Temperature and/or supply voltages must be limited to ensure that the dissipation rating is not exceeded.

■ ELECTRICAL CHARACTERISTICS

(V_{CC}= ± 15V, Ta=25°C, unless otherwise specified)

PARAMETER	SYMBOL	TEST CONDITIONS	MIN	TYP	MAX	UNIT	
Input Offset Voltage	V _{I(OFF)}	R _S =50Ω	Ta=25°C		3	15	mV
			T _{MIN} Ta T _{MAX}			20	mV
Input Common Mode Voltage	V _{I(CM)}		±11	-12~+15		V	
Output Voltage Swing	V _{O(SW)}	R _L =10kΩ, C _L =100pF	Ta=25°C	20	27		V
			T _{MIN} Ta T _{MAX}	20			
Large Signal Voltage Gain	G _V	R _L =10Ω, V _{OUT} =±10V	Ta=25°C	3	6		V/mV
			T _{MIN} Ta T _{MAX}	3			
Temperature Coefficient of Input Offset Voltage	V _{I(OFF)}	R _S =50Ω		10		μV/°C	
Supply Current	I _{CC}	Ta=25°C, no load, no signal		250	350	μA	
Input Offset Current*	I _{I(OFF)}	Ta=25°C		5	200	pA	
		T _{MIN} Ta T _{MAX}			5	nA	
Input Bias Current*	I _{I(BIAS)}	Ta=25°C		30	400	pA	
		T _{MIN} Ta T _{MAX}			10	nA	
Gain Bandwidth Product	GB _W	Ta=25°C, R _L =10kΩ, C _L =100Pf		1		MHz	
Input Resistance	R _{IN}			10 ¹²		Ω	
Common Mode Rejection Ratio	CMR	R _S =50Ω	70	76		dB	
Supply Voltage Rejection Ratio	SVR	R _S =50Ω	70	95		dB	
Slew Rate	SR	V _{IN} =10V, R _L =10kΩ, C _L =100pF, G _V =1	0.91	1.1		V/μs	
Channel Separation	V _{O1} /V _{O2}	G _V =100, Ta=25°C		120		dB	
Total Power Consumption		Ta=25°C, no load, no signal		6	7.5	mW	
Rise Time	t _R	V _{IN} =20mV, R _L =10kΩ, C _L =100pF, G _V =1		0.2		μs	
Overshoot Factor	K _{OV}	V _{IN} =20mV, R _L =10kΩ, C _L =100pF, G _V =1		10		%	
Equivalent Input Noise Voltage	e _N	R _S =100Ω, f=1KHz		42			

*The Input bias currents of a FET-input operational amplifier are normal junction reverse currents, which are temperature sensitive. Pulse techniques must be used that will maintain the junction temperature as close to the ambient temperature as possible.

■ PARAMETER MEASUREMENT INFORMATION

Voltage Follower

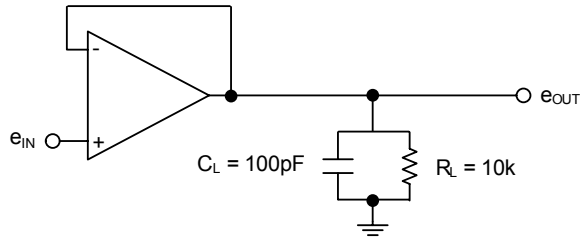

Gain-of-10 Inverting Amplifier

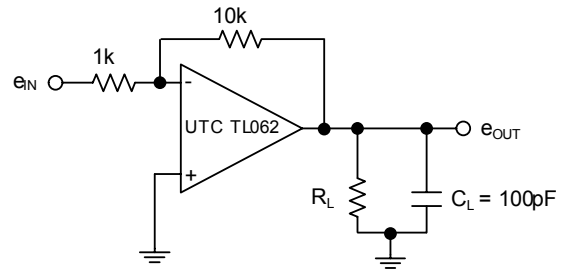

■ TYPICAL CHARACTERISTICS

Maximum Peak-to-Peak Output Voltage vs. Supply Voltage

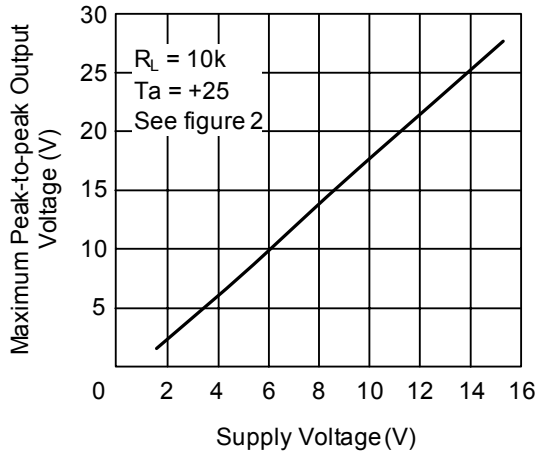

Maximum Peak-to-Peak Output Voltage vs. Free Air Temp.

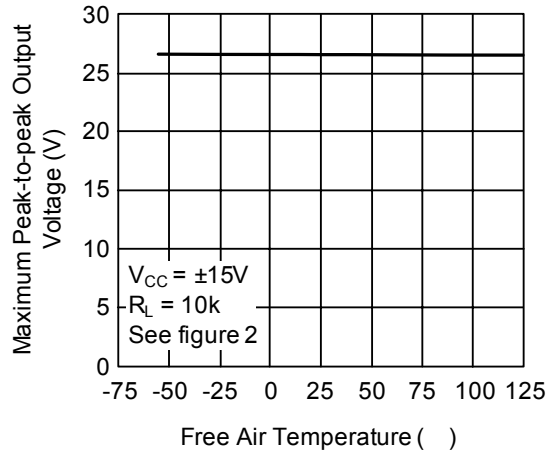

Maximum Peak-to-Peak Output Voltage vs. Load Resistance

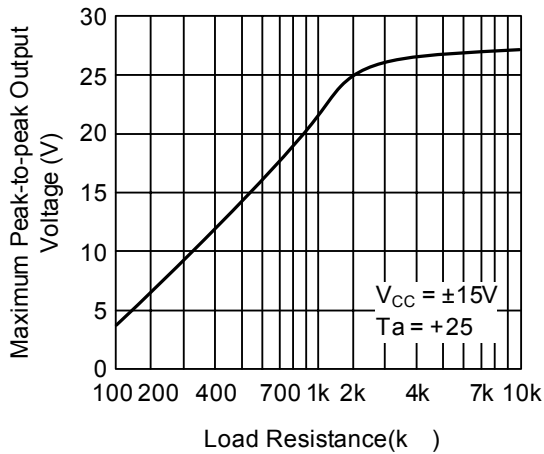

Maximum Peak-to-Peak Output Voltage vs. Frequency

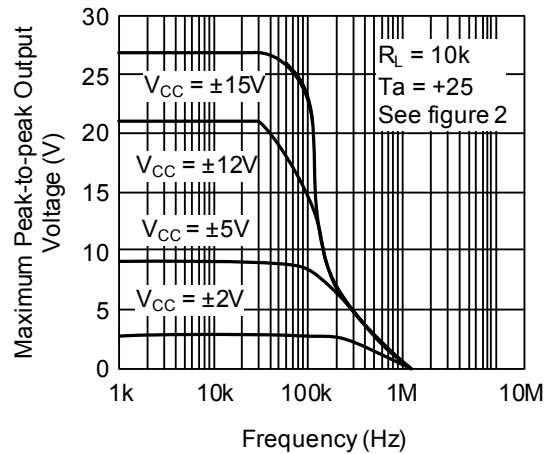

Differential Voltage Amplification vs. Free Air Temperature

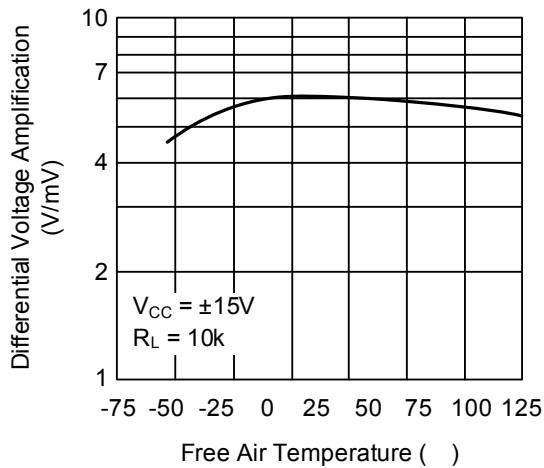

Input Bias Current vs. Free Air Temperature

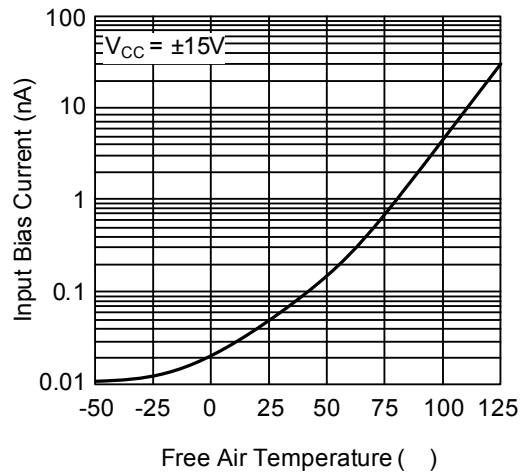

■ TYPICAL CHARACTERISTICS(Cont.)

Supply Current Per Amplifiers.
Supply Voltage

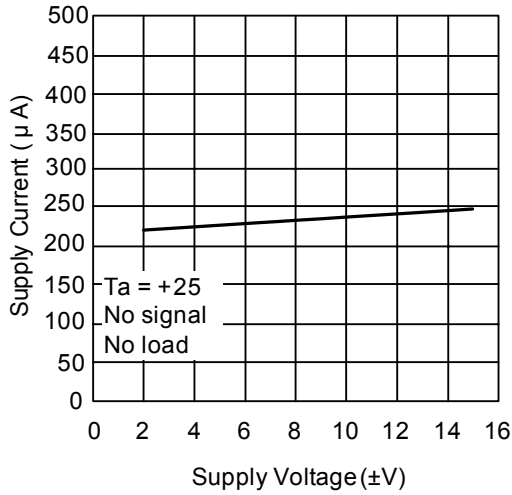

Supply Current Per Amplifiers. Free
Air Temperature

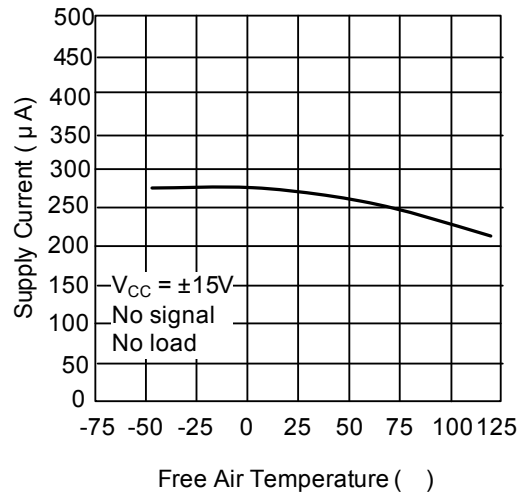

Total Power Dissipated vs. Free Air
Temperature

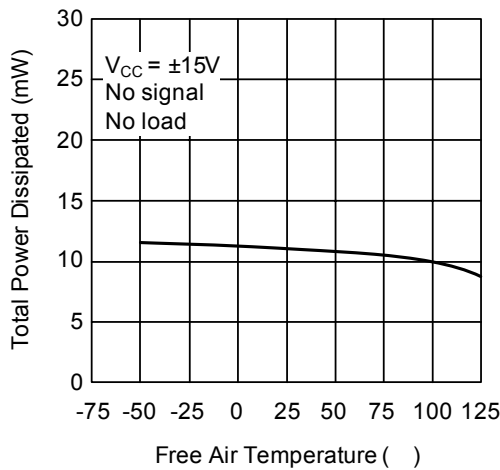

Common Mode Rejection Ratios.
Free Air Temperature

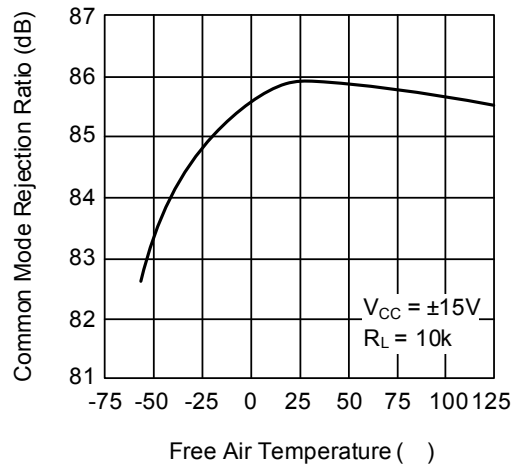

Voltage Follower Large Signal
Pulse Response

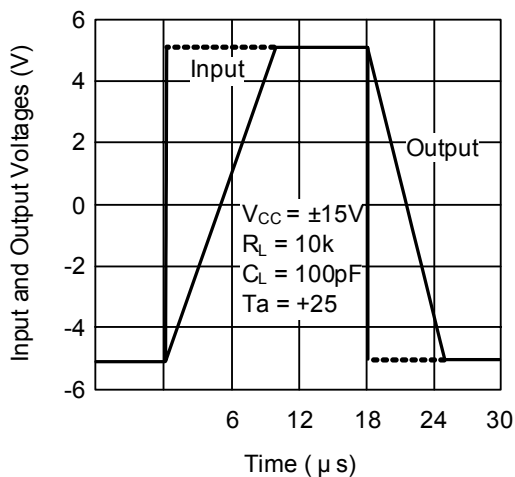

Output Voltage vs. Elapsed Time

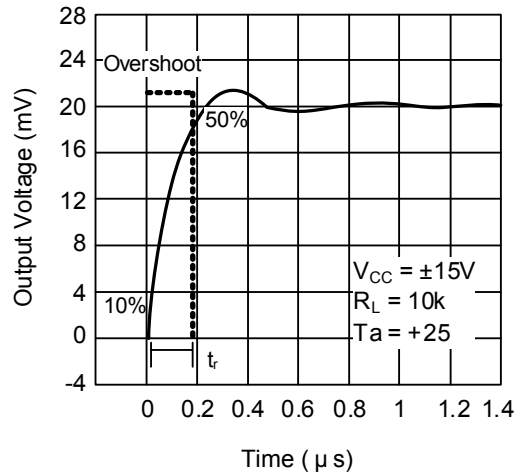

UTC assumes no responsibility for equipment failures that result from using products at values that exceed, even momentarily, rated values (such as maximum ratings, operating condition ranges, or other parameters) listed in products specifications of any and all UTC products described or contained herein. UTC products are not designed for use in life support appliances, devices or systems where malfunction of these products can be reasonably expected to result in personal injury. Reproduction in whole or in part is prohibited without the prior written consent of the copyright owner. The information presented in this document does not form part of any quotation or contract, is believed to be accurate and reliable and may be changed without notice.