

# MPSA13, MPSA14

MPSA14 is a Preferred Device

## Darlington Transistors

### NPN Silicon

#### Features

- Pb-Free Packages are Available\*

#### MAXIMUM RATINGS

Rating	Symbol	Value	Unit
Collector–Emitter Voltage	$V_{CES}$	30	Vdc
Collector–Base Voltage	$V_{CBO}$	30	Vdc
Emitter–Base Voltage	$V_{EBO}$	10	Vdc
Collector Current – Continuous	$I_C$	500	mAdc
Total Device Dissipation @ $T_A = 25^\circ\text{C}$ Derate above $25^\circ\text{C}$	$P_D$	625 5.0	mW mW/ $^\circ\text{C}$
Total Device Dissipation @ $T_C = 25^\circ\text{C}$ Derate above $25^\circ\text{C}$	$P_D$	1.5 12	W mW/ $^\circ\text{C}$
Operating and Storage Junction Temperature Range	$T_J, T_{stg}$	-55 to +150	$^\circ\text{C}$

#### THERMAL CHARACTERISTICS

Characteristic	Symbol	Max	Unit
Thermal Resistance, Junction-to–Ambient	$R_{\theta JA}$	200	$^\circ\text{C}/\text{mW}$
Thermal Resistance, Junction-to–Case	$R_{\theta JC}$	83.3	$^\circ\text{C}/\text{mW}$

Maximum ratings are those values beyond which device damage can occur. Maximum ratings applied to the device are individual stress limit values (not normal operating conditions) and are not valid simultaneously. If these limits are exceeded, device functional operation is not implied, damage may occur and reliability may be affected.



ON Semiconductor®

<http://onsemi.com>

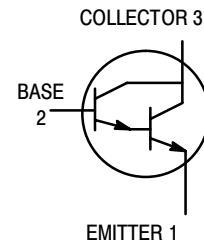

#### MARKING DIAGRAM

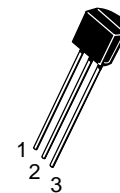

TO-92  
(TO-226AA)  
CASE 29-11  
STYLE 1

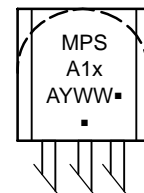

- x = 3 or 4
  - A = Assembly Location
  - Y = Year
  - WW = Work Week
  - = Pb-Free Package
- (Note: Microdot may be in either location)

#### ORDERING INFORMATION

See detailed ordering and shipping information in the package dimensions section on page 2 of this data sheet.

**Preferred** devices are recommended choices for future use and best overall value.

\*For additional information on our Pb-Free strategy and soldering details, please download the ON Semiconductor Soldering and Mounting Techniques Reference Manual, SOLDERRM/D.

# MPSA13, MPSA14

## ELECTRICAL CHARACTERISTICS ( $T_A = 25^\circ\text{C}$ unless otherwise noted)

Characteristic	Symbol	Min	Max	Unit
<b>OFF CHARACTERISTICS</b>				
Collector–Emitter Breakdown Voltage ( $I_C = 100 \mu\text{Adc}$ , $I_B = 0$ )	$V_{(BR)CES}$	30	–	Vdc
Collector Cutoff Current ( $V_{CB} = 30 \text{ Vdc}$ , $I_E = 0$ )	$I_{CBO}$	–	100	nAdc
Emitter Cutoff Current ( $V_{EB} = 10 \text{ Vdc}$ , $I_C = 0$ )	$I_{EBO}$	–	100	nAdc

## ON CHARACTERISTICS (Note 1)

DC Current Gain ( $I_C = 10 \text{ mAdc}$ , $V_{CE} = 5.0 \text{ Vdc}$ )	MPSA13 MPSA14	$h_{FE}$	5,000	–	–
( $I_C = 100 \text{ mAdc}$ , $V_{CE} = 5.0 \text{ Vdc}$ )			10,000	–	–
Collector–Emitter Saturation Voltage ( $I_C = 100 \text{ mAdc}$ , $I_B = 0.1 \text{ mAdc}$ )	MPSA13 MPSA14	$V_{CE(sat)}$	–	1.5	Vdc
Base–Emitter On Voltage ( $I_C = 100 \text{ mAdc}$ , $V_{CE} = 5.0 \text{ Vdc}$ )		$V_{BE(on)}$	–	2.0	Vdc

## SMALL–SIGNAL CHARACTERISTICS

Current–Gain – Bandwidth Product (Note 2) ( $I_C = 10 \text{ mAdc}$ , $V_{CE} = 5.0 \text{ Vdc}$ , $f = 100 \text{ MHz}$ )	$f_T$	125	–	MHz
---	-------	-----	---	-----

1. Pulse Test: Pulse Width  $\leq 300 \mu\text{s}$ ; Duty Cycle  $\leq 2.0\%$ .

2.  $f_T = |h_{fe}| \cdot f_{test}$ .

## ORDERING INFORMATION

Device	Package	Shipping†
MPSA13	TO–92	5000 Units / Box
MPSA13G	TO–92 (Pb–Free)	5000 Units / Box
MPSA13RLRA	TO–92	2000 / Tape & Reel
MPSA13RLRAG	TO–92 (Pb–Free)	2000 / Tape & Reel
MPSA13RLRM	TO–92	2000 / Ammo Pack
MPSA13RLRMG	TO–92 (Pb–Free)	2000 / Ammo Pack
MPSA13RLRP	TO–92	2000 / Ammo Pack
MPSA13RLRPG	TO–92 (Pb–Free)	2000 / Ammo Pack
MPSA13ZL1	TO–92	2000 / Ammo Pack
MPSA13ZL1G	TO–92 (Pb–Free)	2000 / Ammo Pack
MPSA14	TO–92	5000 Units / Box
MPSA14G	TO–92 (Pb–Free)	5000 Units / Box
MPSA14RLRA	TO–92	2000 / Tape & Reel
MPSA14RLRAG	TO–92 (Pb–Free)	2000 / Tape & Reel
MPSA14RLRP	TO–92	2000 / Ammo Pack
MPSA14RLRPG	TO–92 (Pb–Free)	2000 / Ammo Pack

†For information on tape and reel specifications, including part orientation and tape sizes, please refer to our Tape and Reel Packaging Specifications Brochure, BRD8011/D.

# MPSA13, MPSA14

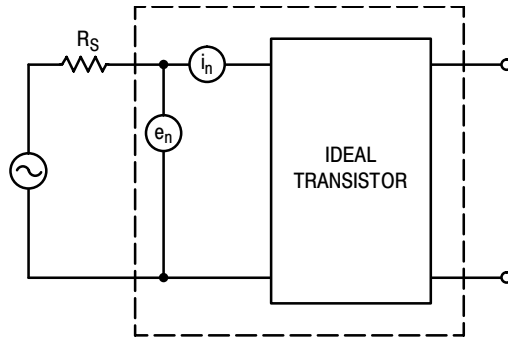

Figure 1. Transistor Noise Model

## NOISE CHARACTERISTICS

( $V_{CE} = 5.0$  Vdc,  $T_A = 25^\circ\text{C}$ )

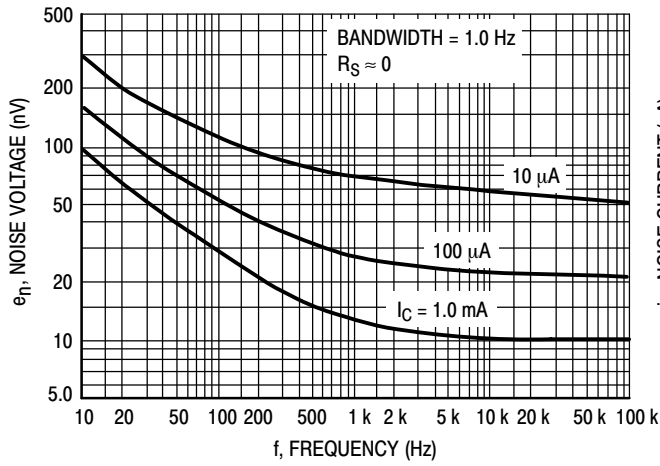

Figure 2. Noise Voltage

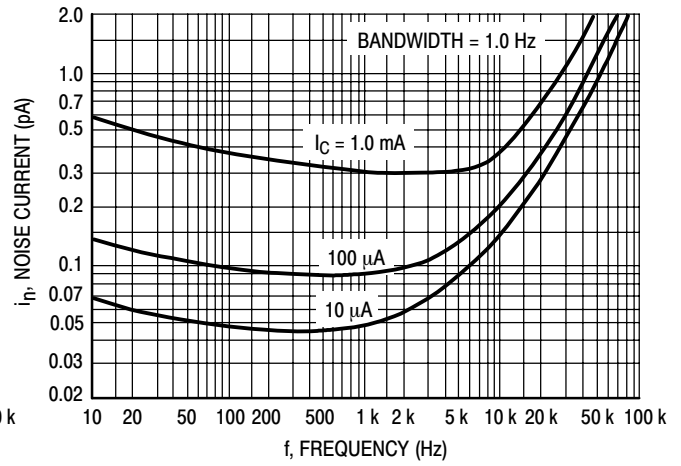

Figure 3. Noise Current

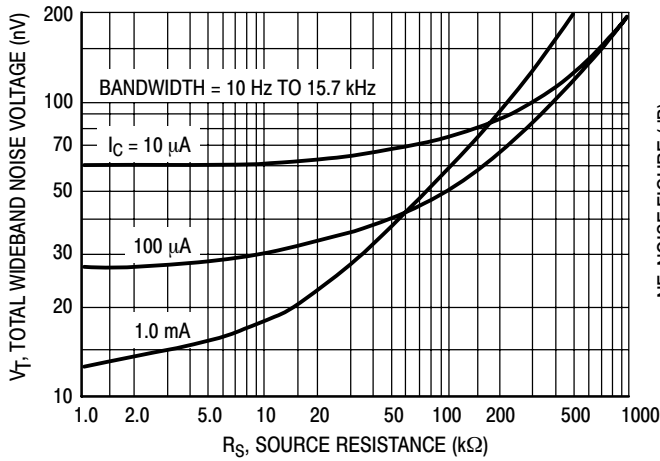

Figure 4. Total Wideband Noise Voltage

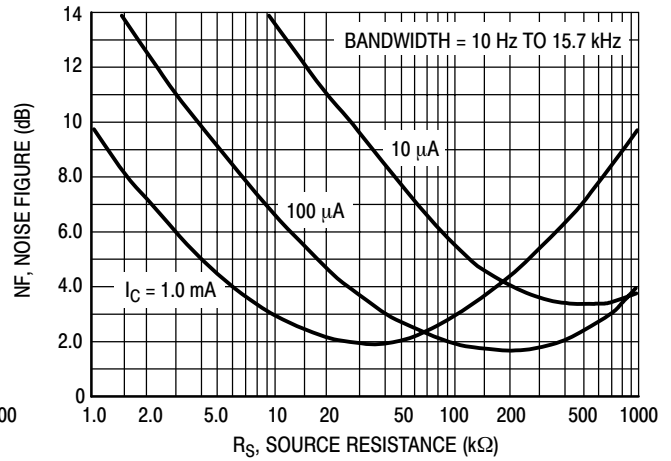

Figure 5. Wideband Noise Figure

# MPSA13, MPSA14

## SMALL-SIGNAL CHARACTERISTICS

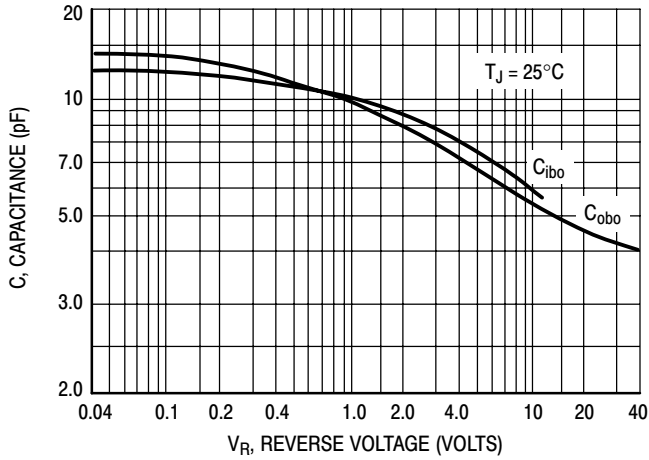

Figure 6. Capacitance

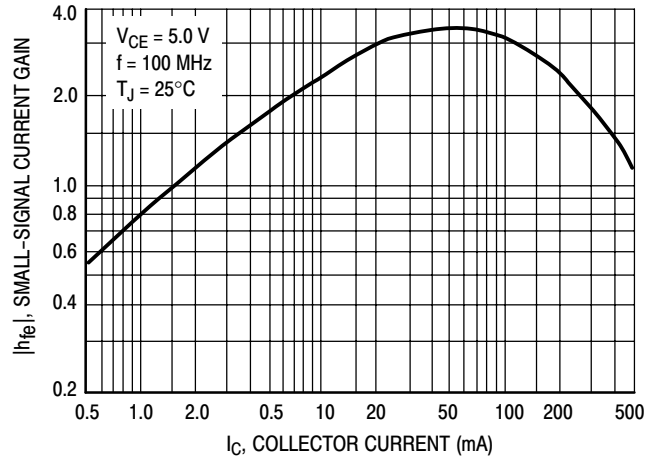

Figure 7. High Frequency Current Gain

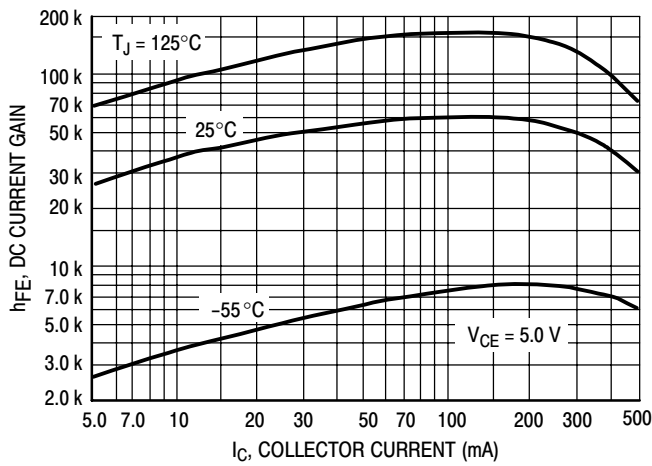

Figure 8. DC Current Gain

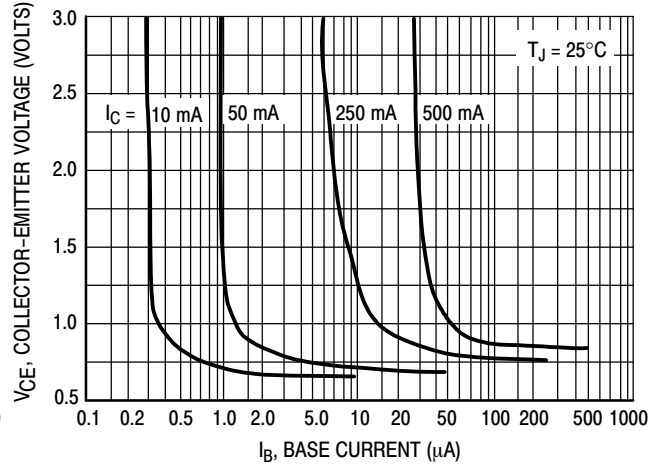

Figure 9. Collector Saturation Region

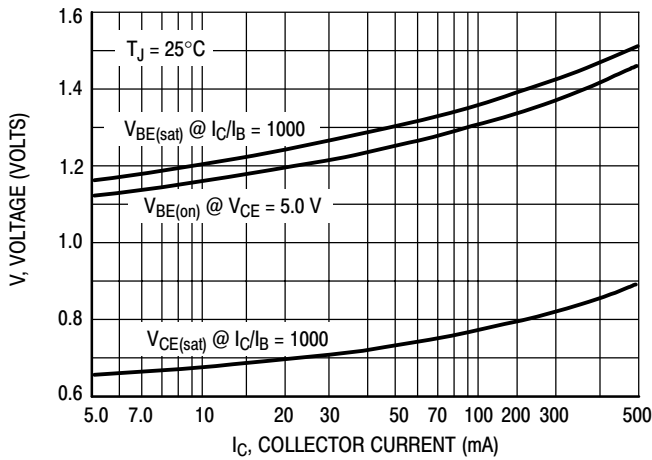

Figure 10. "On" Voltages

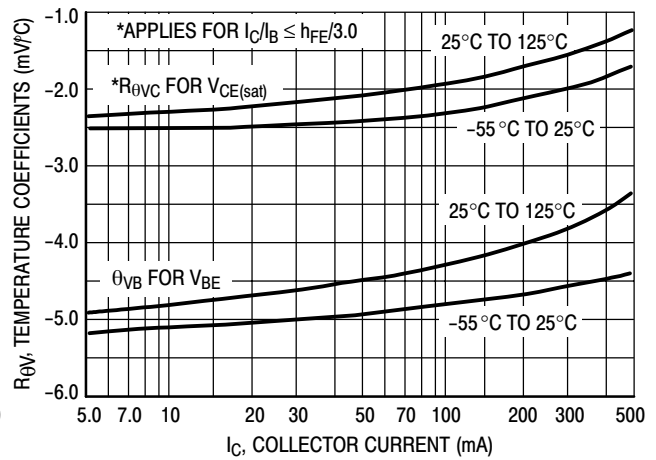

Figure 11. Temperature Coefficients

# MPSA13, MPSA14

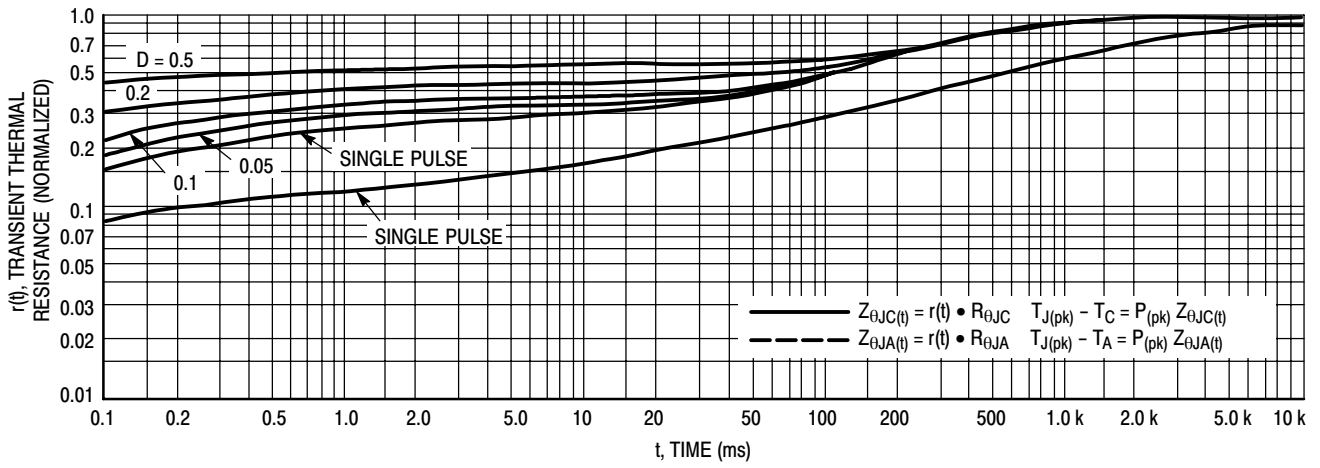

Figure 12. Thermal Response

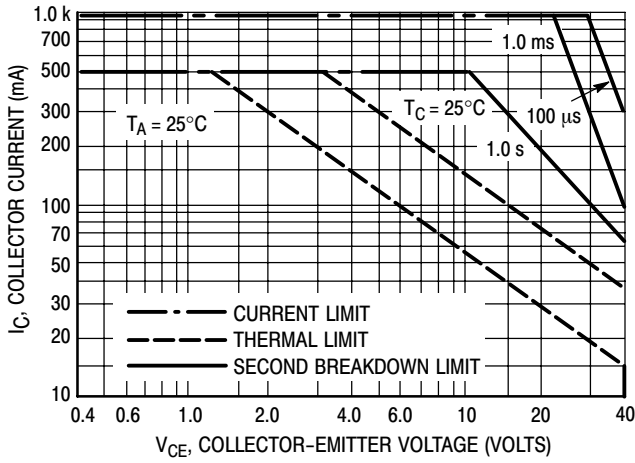
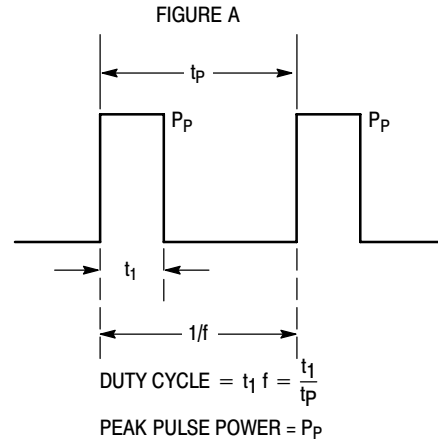

Figure 13. Active Region Safe Operating Area



Design Note: Use of Transient Thermal Resistance Data

# MPSA13, MPSA14

## PACKAGE DIMENSIONS

TO-92  
TO-226AA  
CASE 29-11  
ISSUE AL

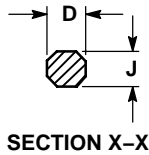
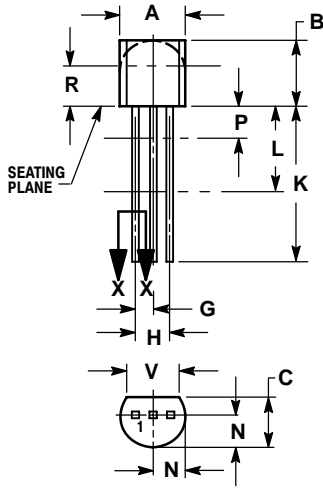

NOTES:

1. DIMENSIONING AND TOLERANCING PER ANSI Y14.5M, 1982.
2. CONTROLLING DIMENSION: INCH.
3. CONTOUR OF PACKAGE BEYOND DIMENSION R IS UNCONTROLLED.
4. LEAD DIMENSION IS UNCONTROLLED IN P AND BEYOND DIMENSION K MINIMUM.

DIM	INCHES		MILLIMETERS	
	MIN	MAX	MIN	MAX
A	0.175	0.205	4.45	5.20
B	0.170	0.210	4.32	5.33
C	0.125	0.165	3.18	4.19
D	0.016	0.021	0.407	0.533
G	0.045	0.055	1.15	1.39
H	0.095	0.105	2.42	2.66
J	0.015	0.020	0.39	0.50
K	0.500	---	12.70	---
L	0.250	---	6.35	---
N	0.080	0.105	2.04	2.66
P	---	0.100	---	2.54
R	0.115	---	2.93	---
V	0.135	---	3.43	---

STYLE 1:

1. EMITTER
2. BASE
3. COLLECTOR

ON Semiconductor and are registered trademarks of Semiconductor Components Industries, LLC (SCILLC). SCILLC reserves the right to make changes without further notice to any products herein. SCILLC makes no warranty, representation or guarantee regarding the suitability of its products for any particular purpose, nor does SCILLC assume any liability arising out of the application or use of any product or circuit, and specifically disclaims any and all liability, including without limitation special, consequential or incidental damages. "Typical" parameters which may be provided in SCILLC data sheets and/or specifications can and do vary in different applications and actual performance may vary over time. All operating parameters, including "Typicals" must be validated for each customer application by customer's technical experts. SCILLC does not convey any license under its patent rights nor the rights of others. SCILLC products are not designed, intended, or authorized for use as components in systems intended for surgical implant into the body, or other applications intended to support or sustain life, or for any other application in which the failure of the SCILLC product could create a situation where personal injury or death may occur. Should Buyer purchase or use SCILLC products for any such unintended or unauthorized application, Buyer shall indemnify and hold SCILLC and its officers, employees, subsidiaries, affiliates, and distributors harmless against all claims, costs, damages, and expenses, and reasonable attorney fees arising out of, directly or indirectly, any claim of personal injury or death associated with such unintended or unauthorized use, even if such claim alleges that SCILLC was negligent regarding the design or manufacture of the part. SCILLC is an Equal Opportunity/Affirmative Action Employer. This literature is subject to all applicable copyright laws and is not for resale in any manner.

### PUBLICATION ORDERING INFORMATION

**LITERATURE FULFILLMENT:**  
Literature Distribution Center for ON Semiconductor  
P.O. Box 61312, Phoenix, Arizona 85082-1312 USA  
**Phone:** 480-829-7710 or 800-344-3860 Toll Free USA/Canada  
**Fax:** 480-829-7709 or 800-344-3867 Toll Free USA/Canada  
**Email:** orderlit@onsemi.com

**N. American Technical Support:** 800-282-9855 Toll Free USA/Canada

**Japan:** ON Semiconductor, Japan Customer Focus Center  
2-9-1 Kamimeguro, Meguro-ku, Tokyo, Japan 153-0051  
**Phone:** 81-3-5773-3850

**ON Semiconductor Website:** <http://onsemi.com>

**Order Literature:** <http://www.onsemi.com/litorder>

For additional information, please contact your local Sales Representative.