

# MMBFU310LT1

Preferred Device

## JFET Transistor

### N-Channel

#### Features

- Pb-Free Package is Available

#### MAXIMUM RATINGS

Rating	Symbol	Value	Unit
Drain-Source Voltage	$V_{DS}$	25	Vdc
Gate-Source Voltage	$V_{GS}$	25	Vdc
Gate Current	$I_G$	10	mAdc

Maximum ratings are those values beyond which device damage can occur. Maximum ratings applied to the device are individual stress limit values (not normal operating conditions) and are not valid simultaneously. If these limits are exceeded, device functional operation is not implied, damage may occur and reliability may be affected.

#### THERMAL CHARACTERISTICS

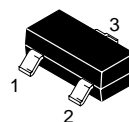
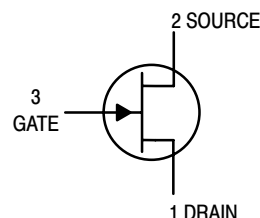
Total Device Dissipation FR-5 Board (Note 1) $T_A = 25^\circ\text{C}$ Derate above $25^\circ\text{C}$	$P_D$	225	mW
		1.8	mW/ $^\circ\text{C}$
Thermal Resistance, Junction-to-Ambient	$R_{\theta JA}$	556	$^\circ\text{C}/\text{W}$
Junction and Storage Temperature	$T_J, T_{stg}$	-55 to +150	$^\circ\text{C}$

1. FR-5 =  $1.0 \times 0.75 \times 0.062$  in.



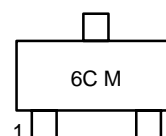
ON Semiconductor®

<http://onsemi.com>



SOT-23 (TO-236AB)  
CASE 318-08  
STYLE 10

#### MARKING DIAGRAM



6C = Specific Device Code  
M = Date Code  
▪ = Pb-Free Package

#### ORDERING INFORMATION

Device	Package	Shipping†
MMBFU310LT1	SOT-23	3000 Tape & Reel
MMBFU310LT1G	SOT-23 (Pb-Free)	3000 Tape & Reel

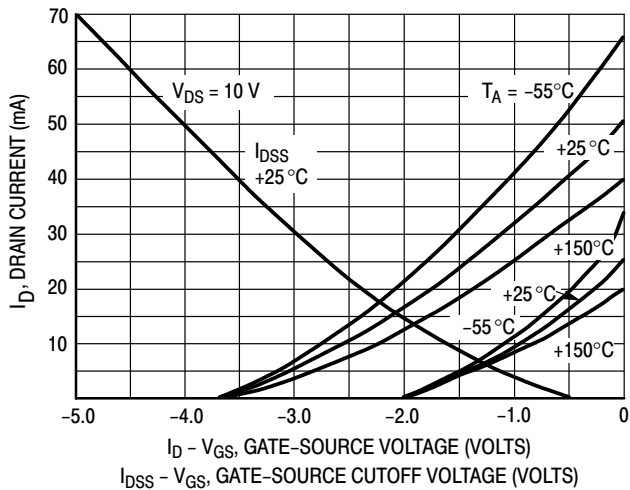
†For information on tape and reel specifications, including part orientation and tape sizes, please refer to our Tape and Reel Packaging Specifications Brochure, BRD8011/D.

Preferred devices are recommended choices for future use and best overall value.

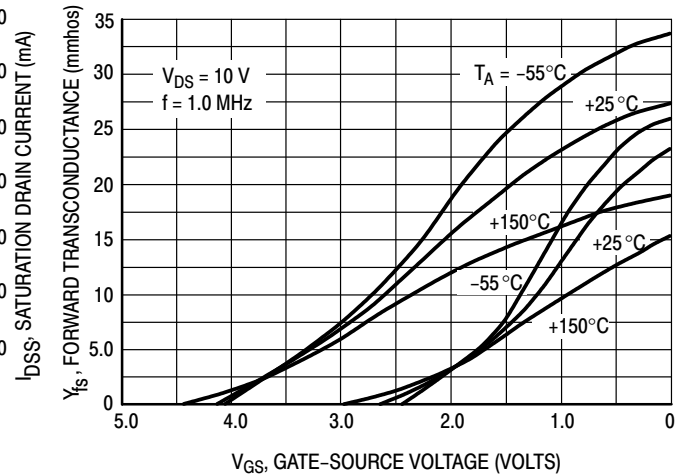
# MMBFU310LT1

## ELECTRICAL CHARACTERISTICS (T<sub>A</sub> = 25°C unless otherwise noted)

Characteristic	Symbol	Min	Max	Unit
<b>OFF CHARACTERISTICS</b>				
Gate-Source Breakdown Voltage - (I <sub>G</sub> = -1.0 μAdc, V <sub>DS</sub> = 0)	V <sub>(BR)GSS</sub>	-25	-	Vdc
Gate 1 Leakage Current - (V <sub>GS</sub> = -15 Vdc, V <sub>DS</sub> = 0)	I <sub>G1SS</sub>	-	-150	pA
Gate 2 Leakage Current - (V <sub>GS</sub> = -15 Vdc, V <sub>DS</sub> = 0, T <sub>A</sub> = 125°C)	I <sub>G2SS</sub>	-	-150	nAdc
Gate Source Cutoff Voltage - (V <sub>DS</sub> = 10 Vdc, I <sub>D</sub> = 1.0 nAdc)	V <sub>GS(off)</sub>	-2.5	-6.0	Vdc
<b>ON CHARACTERISTICS</b>				
Zero-Gate-Voltage Drain Current - (V <sub>DS</sub> = 10 Vdc, V <sub>GS</sub> = 0)	I <sub>DSS</sub>	24	60	mAdc
Gate-Source Forward Voltage - (I <sub>G</sub> = 10 mAdc, V <sub>DS</sub> = 0)	V <sub>GS(f)</sub>	-	1.0	Vdc
<b>SMALL-SIGNAL CHARACTERISTICS</b>				
Forward Transfer Admittance - (V <sub>DS</sub> = 10 Vdc, I <sub>D</sub> = 10 mAdc, f = 1.0 kHz)	Y <sub>fs</sub>	10	18	mmhos
Output Admittance - (V <sub>DS</sub> = 10 Vdc, I <sub>D</sub> = 10 mAdc, f = 1.0 kHz)	y <sub>os</sub>	-	250	μmhos
Input Capacitance - (V <sub>GS</sub> = -10 Vdc, V <sub>DS</sub> = 0 Vdc, f = 1.0 MHz)	C <sub>iss</sub>	-	5.0	pF
Reverse Transfer Capacitance - (V <sub>GS</sub> = -10 Vdc, V <sub>DS</sub> = 0 Vdc, f = 1.0 MHz)	C <sub>rss</sub>	-	2.5	pF

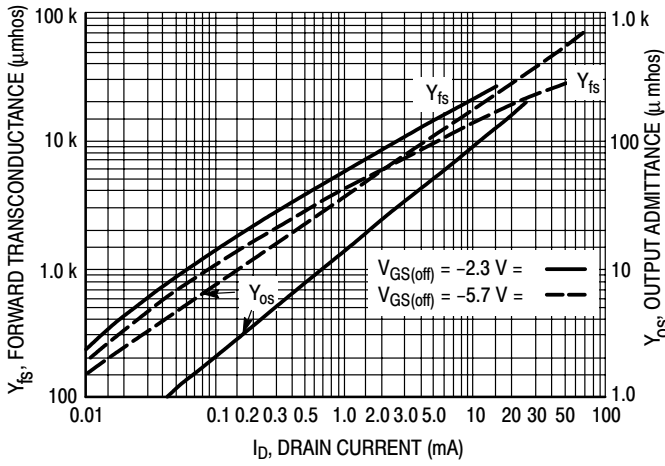


**Figure 1. Drain Current and Transfer Characteristics vs Gate-Source Voltage**

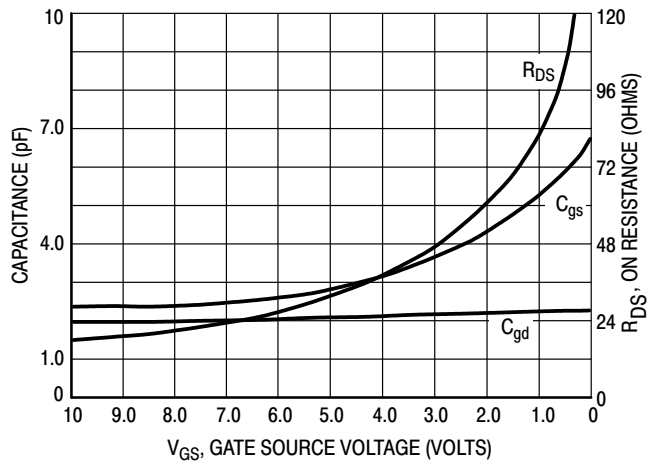


**Figure 2. Forward Transconductance vs Gate-Source Voltage**

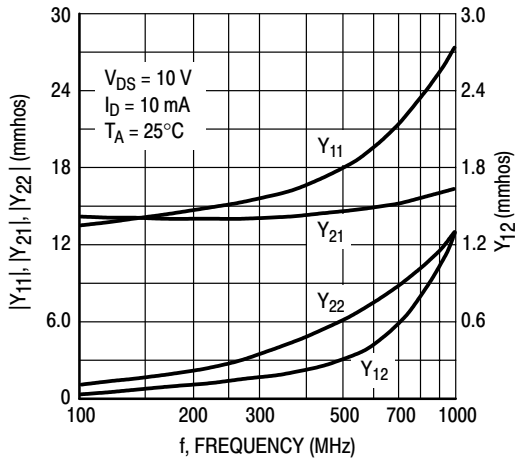
# MMBFU310LT1



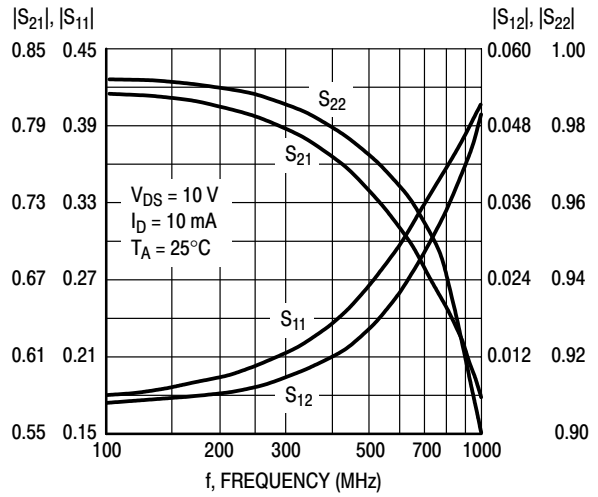
**Figure 3. Common-Source Output Admittance and Forward Transconductance vs Drain Current**



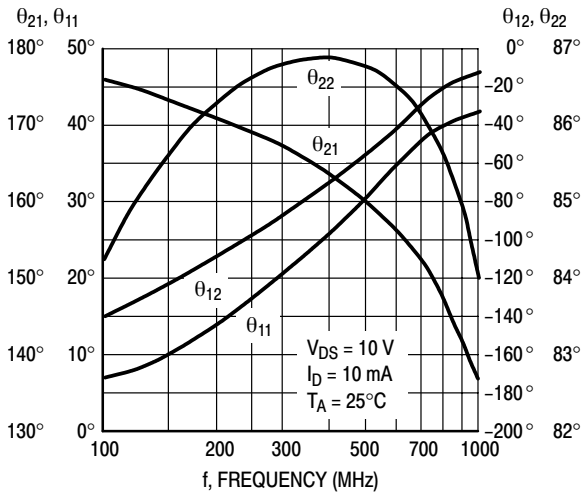
**Figure 4. On Resistance and Junction Capacitance vs Gate-Source Voltage**



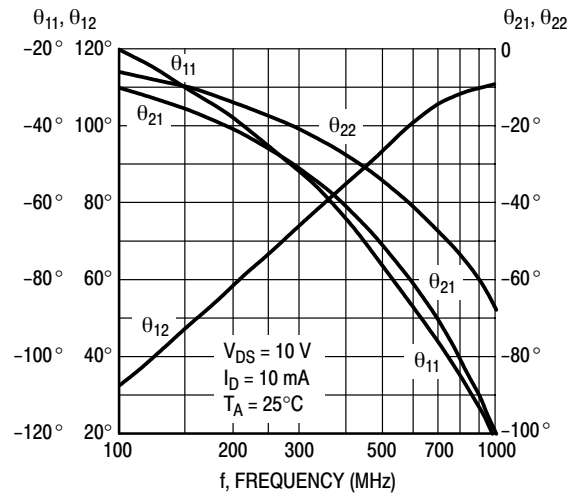
**Figure 5. Common-Gate Y Parameter Magnitude vs Frequency**



**Figure 6. Common-Gate S Parameter Magnitude vs Frequency**



**Figure 7. Common-Gate Y Parameter Phase-Angle vs Frequency**

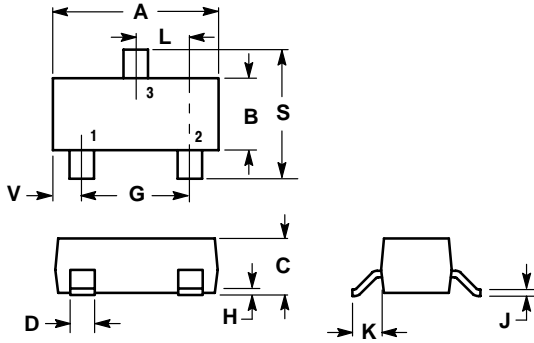


**Figure 8. S Parameter Phase-Angle vs Frequency**

# MMBFU310LT1

## PACKAGE DIMENSIONS

SOT-23 (TO-236AB)  
CASE 318-08  
ISSUE AH



**NOTES:**

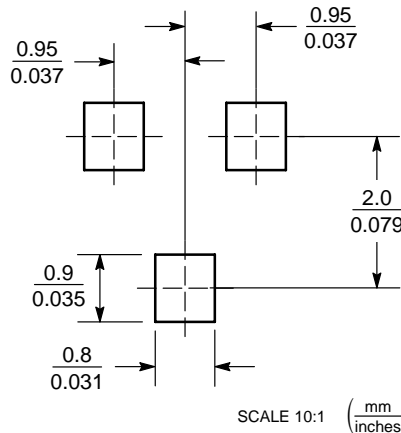
1. DIMENSIONING AND TOLERANCING PER ANSI Y14.5M, 1982.
2. CONTROLLING DIMENSION: INCH.
3. MAXIMUM LEAD THICKNESS INCLUDES LEAD FINISH THICKNESS. MINIMUM LEAD THICKNESS IS THE MINIMUM THICKNESS OF BASE MATERIAL.
4. 318-01 THRU -07 AND -09 OBSOLETE, NEW STANDARD 318-08.

DIM	INCHES		MILLIMETERS	
	MIN	MAX	MIN	MAX
A	0.1102	0.1197	2.80	3.04
B	0.0472	0.0551	1.20	1.40
C	0.0350	0.0440	0.89	1.11
D	0.0150	0.0200	0.37	0.50
G	0.0701	0.0807	1.78	2.04
H	0.0005	0.0040	0.013	0.100
J	0.0034	0.0070	0.085	0.177
K	0.0140	0.0285	0.35	0.69
L	0.0350	0.0401	0.89	1.02
S	0.0830	0.1039	2.10	2.64
V	0.0177	0.0236	0.45	0.60


**STYLE 10:**

1. DRAIN
2. SOURCE
3. GATE

### SOLDERING FOOTPRINT\*



\*For additional information on our Pb-Free strategy and soldering details, please download the ON Semiconductor Soldering and Mounting Techniques Reference Manual, SOLDERRM/D.

ON Semiconductor and  are registered trademarks of Semiconductor Components Industries, LLC (SCILLC). SCILLC reserves the right to make changes without further notice to any products herein. SCILLC makes no warranty, representation or guarantee regarding the suitability of its products for any particular purpose, nor does SCILLC assume any liability arising out of the application or use of any product or circuit, and specifically disclaims any and all liability, including without limitation special, consequential or incidental damages. "Typical" parameters which may be provided in SCILLC data sheets and/or specifications can and do vary in different applications and actual performance may vary over time. All operating parameters, including "Typicals" must be validated for each customer application by customer's technical experts. SCILLC does not convey any license under its patent rights nor the rights of others. SCILLC products are not designed, intended, or authorized for use as components in systems intended for surgical implant into the body, or other applications intended to support or sustain life, or for any other application in which the failure of the SCILLC product could create a situation where personal injury or death may occur. Should Buyer purchase or use SCILLC products for any such unintended or unauthorized application, Buyer shall indemnify and hold SCILLC and its officers, employees, subsidiaries, affiliates, and distributors harmless against all claims, costs, damages, and expenses, and reasonable attorney fees arising out of, directly or indirectly, any claim of personal injury or death associated with such unintended or unauthorized use, even if such claim alleges that SCILLC was negligent regarding the design or manufacture of the part. SCILLC is an Equal Opportunity/Affirmative Action Employer. This literature is subject to all applicable copyright laws and is not for resale in any manner.

### PUBLICATION ORDERING INFORMATION

**LITERATURE FULFILLMENT:**

Literature Distribution Center for ON Semiconductor  
P.O. Box 61312, Phoenix, Arizona 85082-1312 USA  
**Phone:** 480-829-7710 or 800-344-3860 Toll Free USA/Canada  
**Fax:** 480-829-7709 or 800-344-3867 Toll Free USA/Canada  
**Email:** orderlit@onsemi.com

**N. American Technical Support:** 800-282-9855 Toll Free USA/Canada

**Japan:** ON Semiconductor, Japan Customer Focus Center  
2-9-1 Kamimeguro, Meguro-ku, Tokyo, Japan 153-0051  
**Phone:** 81-3-5773-3850

**ON Semiconductor Website:** <http://onsemi.com>

**Order Literature:** <http://www.onsemi.com/litorder>

For additional information, please contact your local Sales Representative.