

MC74ACT640

Octal 3-State Inverting Transceiver

The MC74ACT640 octal bus transceiver is designed for asynchronous two-way communication between data buses. The device transmits data from bus \bar{A} to bus B when $T/\bar{R} = \text{HIGH}$, or from bus \bar{B} to bus A when $T/\bar{R} = \text{LOW}$. The enable input can be used to disable the device so the buses are effectively isolated.

Features

- Bidirectional Data Path
- A and B Outputs Sink 24 mA/Source -24 mA
- TTL Compatible Inputs
- Pb-Free Packages are Available*

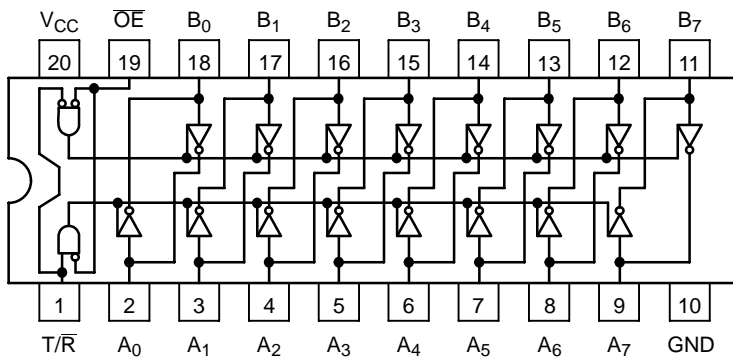

Figure 1. Pinout: 20-Lead Packages Conductors (Top View)

PIN ASSIGNMENT

PIN	FUNCTION
A ₀ -A ₇	Side A Inputs or 3-State Outputs
\overline{OE}	Output Enable Input
T/R	Transmit/Receive Input
B ₀ -B ₇	Side B Inputs or 3-State Outputs

TRUTH TABLE

OE	T/R	Applied Inputs	Valid Direction I/P → O/P	Output
H	X	X	X	X
L	H	H	\bar{A} to B	L
L	H	L	\bar{A} to B	H
L	L	H	\bar{B} to A	L
L	L	L	\bar{B} to A	H

H = HIGH Voltage Level
L = LOW Voltage Level
X = Immaterial

*For additional information on our Pb-Free strategy and soldering details, please download the ON Semiconductor Soldering and Mounting Techniques Reference Manual, SOLDERRM/D.



ON Semiconductor®

<http://onsemi.com>

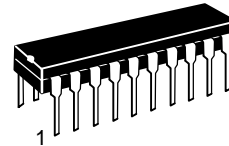

PDIP-20
N SUFFIX
CASE 738

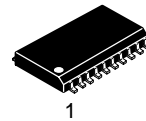

SOIC-20W
DW SUFFIX
CASE 751D

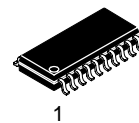

SOEIAJ-20
M SUFFIX
CASE 967

ORDERING INFORMATION

Device	Package	Shipping†
MC74ACT640N	PDIP-20	18 Units/Rail
MC74ACT640NG	PDIP-20 (Pb-Free)	18 Units/Rail
MC74ACT640DW	SOIC-20	38 Units/Rail
MC74ACT640DWG	SOIC-20 (Pb-Free)	38 Units/Rail
MC74ACT640DWR2	SOIC-20	1000 / Tape & Reel
MC74ACT640DWR2G	SOIC-20 (Pb-Free)	1000 / Tape & Reel
MC74ACT640MEL	SOEIAJ-20	2000 / Tape & Reel
MC74ACT640MELG	SOEIAJ-20 (Pb-Free)	2000 / Tape & Reel

†For information on tape and reel specifications, including part orientation and tape sizes, please refer to our Tape and Reel Packaging Specifications Brochure, BRD8011/D.

DEVICE MARKING INFORMATION

See general marking information in the device marking section on page 4 of this data sheet.

MC74ACT640

MAXIMUM RATINGS

Symbol	Parameter	Value	Unit
V_{CC}	DC Supply Voltage	-0.5 to +7.0	V
V_I	DC Input Voltage	$-0.5 \leq V_I \leq V_{CC} + 0.5$	V
V_O	DC Output Voltage (Note 1)	$-0.5 \leq V_O \leq V_{CC} + 0.5$	V
I_{IK}	DC Input Diode Current	± 20	mA
I_{OK}	DC Output Diode Current	± 50	mA
I_O	DC Output Sink/Source Current	± 50	mA
I_{CC}	DC Supply Current per Output Pin	± 50	mA
I_{GND}	DC Ground Current per Output Pin	± 50	mA
T_{STG}	Storage Temperature Range	-65 to +150	°C
T_L	Lead temperature, 1 mm from Case for 10 Seconds	260	°C
T_J	Junction temperature under Bias	+150	°C
θ_{JA}	Thermal resistance	PDIP SOIC 67 96	°C/W
P_D	Power Dissipation in Still Air at 85°C	PDIP SOIC 750 500	mW
MSL	Moisture Sensitivity	Level 1	
F_R	Flammability Rating	Oxygen Index: 30% – 35% UL 94 V-0 @ 0.125 in	
V_{ESD}	ESD Withstand Voltage	Human Body Model (Note 2) Machine Model (Note 3) Charged Device Model (Note 4) > 2000 > 200 > 1000	V
$I_{Latchup}$	Latchup Performance	Above V_{CC} and Below GND at 85°C (Note 5)	± 100 mA

Stresses exceeding Maximum Ratings may damage the device. Maximum Ratings are stress ratings only. Functional operation above the Recommended Operating Conditions is not implied. Extended exposure to stresses above the Recommended Operating Conditions may affect device reliability.

1. I_O absolute maximum rating must be observed.
2. Tested to EIA/JESD22-A114-A.
3. Tested to EIA/JESD22-A115-A.
4. Tested to JESD22-C101-A.
5. Tested to EIA/JESD78.

RECOMMENDED OPERATING CONDITIONS

Symbol	Parameter	Min	Typ	Max	Unit
V_{CC}	DC Input Voltage (Referenced to GND)	4.5		5.5	V
V_{in}, V_{out}	DC Input Voltage, Output Voltage (Referenced to GND)	0		V_{CC}	V
T_A	Operating Temperature, All Package Types	-40	25	+85	°C
t_r, t_f	Input Rise and Fall Time (Note 7)	$V_{CC} = 4.5\text{ V}$ $V_{CC} = 5.5\text{ V}$ 0 0	10 8.0	10 8.0	ns/V
T_J	Junction Temperature (PDIP)			140	°C
I_{OH}	Output Current – High			-24	mA
I_{OL}	Output Current – Low			24	mA

6. Unused Inputs may not be left open. All inputs must be tied to a high voltage level or low logic voltage level.
7. V_{in} from 0.8 V to 2.0 V; refer to individual Data Sheets for devices that differ from the typical input rise and fall times.

MC74ACT640

DC CHARACTERISTICS

Symbol	Parameter	V _{CC} (V)	T _A = +25°C		T _A = -40°C to +85°C	Unit	Conditions
			Typ	Guaranteed Limits			
V _{IH}	Minimum High Level Input Voltage	4.5	1.5	2.0	2.0	V	V _{OUT} = 0.1 V or V _{CC} - 0.1 V
		5.5	1.5	2.0	2.0	V	
V _{IL}	Maximum Low Level Input Voltage	4.5	1.5	0.8	0.8	V	V _{OUT} = 0.1 V or V _{CC} - 0.1 V
		5.5	1.5	0.8	0.8	V	
V _{OH}	Minimum High Level Output Voltage	4.5	4.49	4.4	4.4	V	I _{OUT} = -50 μA
		5.5	5.49	5.4	5.4	V	
V _{OL}	Maximum Low Level Output Voltage	4.5		3.86	3.76	V	*V _{IN} = V _{IL} or V _{IH} -24 mA I _{OH} -24 mA
		5.5		4.86	4.76	V	
V _{OL}	Maximum Low Level Output Voltage	4.5	0.001	0.1	0.1	V	I _{OUT} = 50 μA
		5.5	0.001	0.1	0.1	V	
I _{IN}	Maximum Input Leakage Current	4.5		0.36	0.44	V	*V _{IN} = V _{IL} or V _{IH} -24 mA I _{OH} -24 mA
		5.5		0.36	0.44	V	
I _{IN}	Maximum Input Leakage Current	5.5		±0.1	±1.0	μA	V _I = V _{CC} , GND
ΔI _{CCT}	Additional Max. I _{CC} /Input	5.5	0.6		1.5	mA	V _I = V _{CC} - 2.1 V
I _{OZ}	Maximum 3-State Current	5.5		±0.5	±5.0	μA	V _I (OE) = V _{IL} , V _{IH} V _I = V _{CC} , GND V _O = V _{CC} , GND
I _{OLD} I _{OHD}	†Minimum Dynamic Output Current	5.5 5.5			75 -75	mA mA	V _{OLD} = 1.65 V Max
I _{CC}	Maximum Quiescent Supply Current	5.5		8.0	80	μA	V _{IN} = V _{CC} or GND

*All outputs loaded; thresholds on input associated with output under test.

†Maximum test duration 2.0 ms, one output loaded at a time.

AC CHARACTERISTICS t_r = t_f = 3.0 ns (For Figures and Waveforms, See Figures 2 and 3.)

Symbol	Parameter	V _{CC} * (V)	T _A = +25°C C _L = 50 pF		T _A = -40°C to +85°C C _L = 50 pF		Unit
			Min	Max	Min	Max	
t _{PLH}	Propagation Delay An to Bn or Bn to An	5.0	1.5	8.0	1.0	8.5	ns
t _{PHL}	Propagation Delay An to Bn or Bn to An	5.0	1.5	8.0	1.0	9.0	ns
t _{PZH}	Output Enable Time \overline{OE} to An or Bn	5.0	1.5	10.0	1.0	11.0	ns
t _{PZL}	Output Enable Time \overline{OE} to An or Bn	5.0	1.5	10.0	1.0	11.0	ns
t _{PHZ}	Output Disable Time T/ \overline{R} or \overline{OE} to An or Bn	5.0	1.5	10.0	1.0	11.0	ns
t _{PLZ}	Output Disable Time T/ \overline{R} or \overline{OE} to An or Bn	5.0	1.5	10.0	1.0	11.0	ns

*Voltage Range 5.0 V is 5.0 V ±0.5 V

CAPACITANCE

Symbol	Parameter	Value Typ	Unit	Test Conditions
C _{IN}	Input Capacitance	4.5	pF	V _{CC} = 5.0 V
C _{I/O}	Input/Output Capacitance	15	pF	V _{CC} = 5.0 V
C _{PD}	Power Dissipation Capacitance	45	pF	V _{CC} = 5.0 V

MC74ACT640

SWITCHING WAVEFORMS

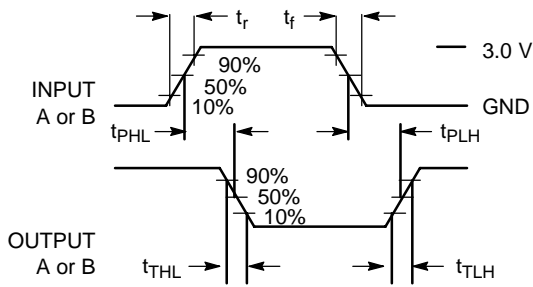

Figure 2.

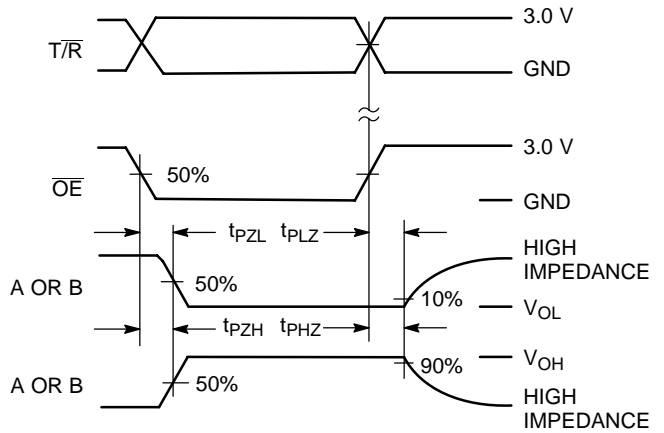
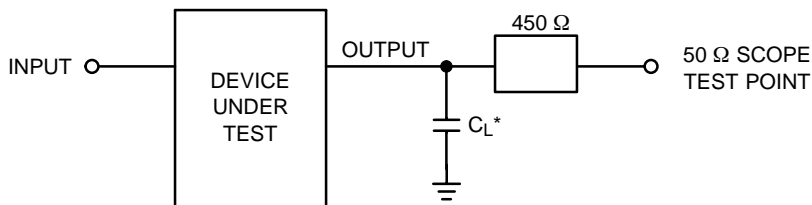

Figure 3.



*Includes all probe and jig capacitance

Figure 4. Test Circuit

MARKING DIAGRAMS

PDIP-20

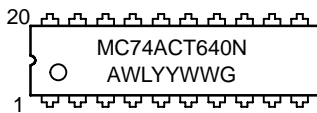

SOIC-20W

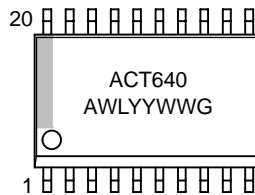

SOEIAJ-20

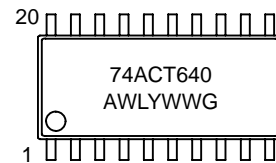

A = Assembly Location
 WL = Wafer Lot
 YY, Y = Year
 WW = Work Week
 G = Pb-Free Package

MC74ACT640

PACKAGE DIMENSIONS

PDIP-20
N SUFFIX
PLASTIC DIP PACKAGE
CASE 738-03
ISSUE E

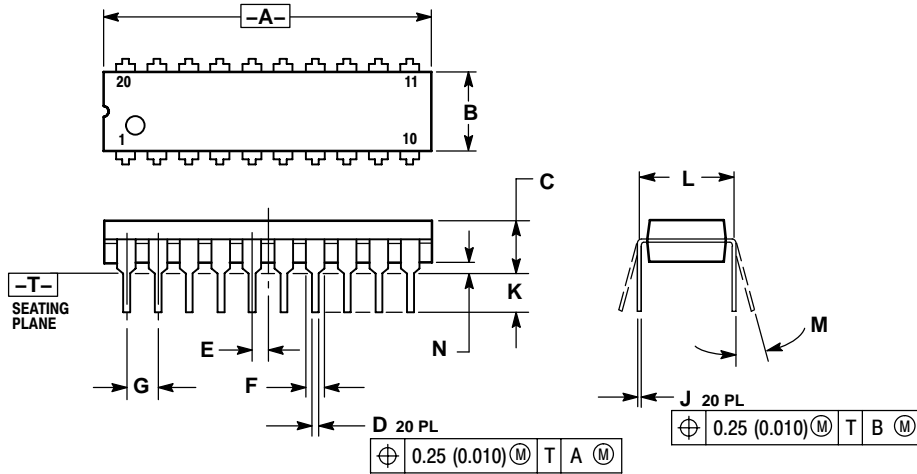

NOTES:

1. DIMENSIONING AND TOLERANCING PER ANSI Y14.5M, 1982.
2. CONTROLLING DIMENSION: INCH.
3. DIMENSION L TO CENTER OF LEAD WHEN FORMED PARALLEL.
4. DIMENSION B DOES NOT INCLUDE MOLD FLASH.

DIM	INCHES		MILLIMETERS	
	MIN	MAX	MIN	MAX
A	1.010	1.070	25.66	27.17
B	0.240	0.260	6.10	6.60
C	0.150	0.180	3.81	4.57
D	0.015	0.022	0.39	0.55
E	0.050 BSC		1.27 BSC	
F	0.050	0.070	1.27	1.77
G	0.100 BSC		2.54 BSC	
J	0.008	0.015	0.21	0.38
K	0.110	0.140	2.80	3.55
L	0.300 BSC		7.62 BSC	
M	0°	15°	0°	15°
N	0.020	0.040	0.51	1.01

SOIC-20W
DW SUFFIX
CASE 751D-05
ISSUE G

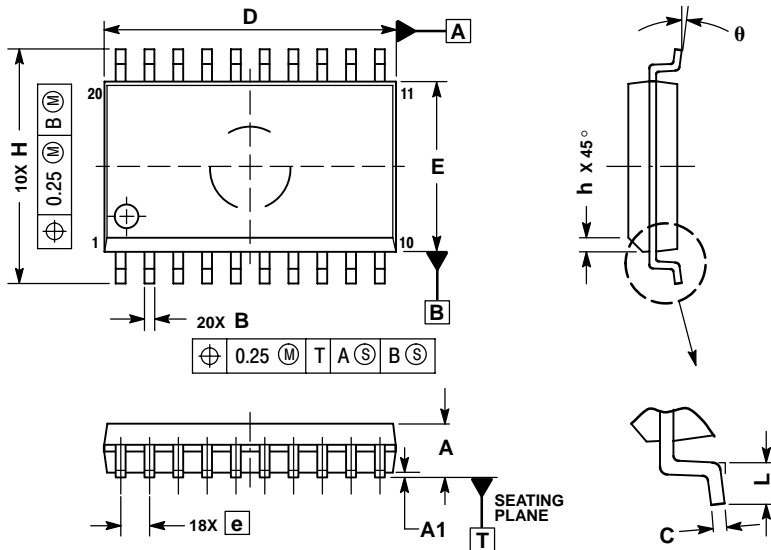

NOTES:

1. DIMENSIONS ARE IN MILLIMETERS.
2. INTERPRET DIMENSIONS AND TOLERANCES PER ASME Y14.5M, 1994.
3. DIMENSIONS D AND E DO NOT INCLUDE MOLD PROTRUSION.
4. MAXIMUM MOLD PROTRUSION 0.15 PER SIDE.
5. DIMENSION B DOES NOT INCLUDE DAMBAR PROTRUSION. ALLOWABLE PROTRUSION SHALL BE 0.13 TOTAL IN EXCESS OF B DIMENSION AT MAXIMUM MATERIAL CONDITION.

DIM	MILLIMETERS	
	MIN	MAX
A	2.35	2.65
A1	0.10	0.25
B	0.35	0.49
C	0.23	0.32
D	12.65	12.95
E	7.40	7.60
e	1.27 BSC	
H	10.05	10.55
h	0.25	0.75
L	0.50	0.90
θ	0°	7°

MC74ACT640

PACKAGE DIMENSIONS

SOEIAJ-20
M SUFFIX
CASE 967-01
ISSUE A

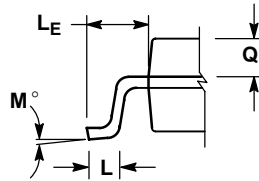
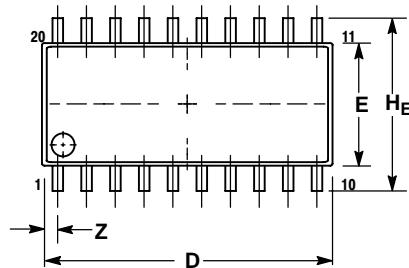

DETAIL P

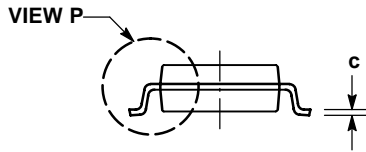
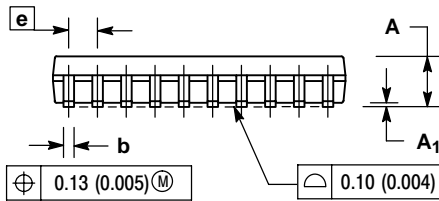

NOTES:

1. DIMENSIONING AND TOLERANCING PER ANSI Y14.5M, 1982.
2. CONTROLLING DIMENSION: MILLIMETER.
3. DIMENSIONS D AND E DO NOT INCLUDE MOLD FLASH OR PROTRUSIONS AND ARE MEASURED AT THE PARTING LINE. MOLD FLASH OR PROTRUSIONS SHALL NOT EXCEED 0.15 (0.006) PER SIDE.
4. TERMINAL NUMBERS ARE SHOWN FOR REFERENCE ONLY.
5. THE LEAD WIDTH DIMENSION (b) DOES NOT INCLUDE DAMBAR PROTRUSION. ALLOWABLE DAMBAR PROTRUSION SHALL BE 0.08 (0.003) TOTAL IN EXCESS OF THE LEAD WIDTH DIMENSION AT MAXIMUM MATERIAL CONDITION. DAMBAR CANNOT BE LOCATED ON THE LOWER RADIUS OR THE FOOT. MINIMUM SPACE BETWEEN PROTRUSIONS AND ADJACENT LEAD TO BE 0.46 (0.018).

DIM	MILLIMETERS		INCHES	
	MIN	MAX	MIN	MAX
A	---	2.05	---	0.081
A ₁	0.05	0.20	0.002	0.008
b	0.35	0.50	0.014	0.020
c	0.15	0.25	0.006	0.010
D	12.35	12.80	0.486	0.504
E	5.10	5.45	0.201	0.215
e	1.27 BSC		0.050 BSC	
H _E	7.40	8.20	0.291	0.323
L	0.50	0.85	0.020	0.033
L _E	1.10	1.50	0.043	0.059
M	0°	10°	0°	10°
Q ₁	0.70	0.90	0.028	0.035
Z	---	0.81	---	0.032

ON Semiconductor and **ON** are registered trademarks of Semiconductor Components Industries, LLC (SCILLC). SCILLC reserves the right to make changes without further notice to any products herein. SCILLC makes no warranty, representation or guarantee regarding the suitability of its products for any particular purpose, nor does SCILLC assume any liability arising out of the application or use of any product or circuit, and specifically disclaims any and all liability, including without limitation special, consequential or incidental damages. "Typical" parameters which may be provided in SCILLC data sheets and/or specifications can and do vary in different applications and actual performance may vary over time. All operating parameters, including "Typicals" must be validated for each customer application by customer's technical experts. SCILLC does not convey any license under its patent rights nor the rights of others. SCILLC products are not designed, intended, or authorized for use as components in systems intended for surgical implant into the body, or other applications intended to support or sustain life, or for any other application in which the failure of the SCILLC product could create a situation where personal injury or death may occur. Should Buyer purchase or use SCILLC products for any such unintended or unauthorized application, Buyer shall indemnify and hold SCILLC and its officers, employees, subsidiaries, affiliates, and distributors harmless against all claims, costs, damages, and expenses, and reasonable attorney fees arising out of, directly or indirectly, any claim of personal injury or death associated with such unintended or unauthorized use, even if such claim alleges that SCILLC was negligent regarding the design or manufacture of the part. SCILLC is an Equal Opportunity/Affirmative Action Employer. This literature is subject to all applicable copyright laws and is not for resale in any manner.

PUBLICATION ORDERING INFORMATION

LITERATURE FULFILLMENT:
Literature Distribution Center for ON Semiconductor
P.O. Box 5163, Denver, Colorado 80217 USA
Phone: 303-675-2175 or 800-344-3860 Toll Free USA/Canada
Fax: 303-675-2176 or 800-344-3867 Toll Free USA/Canada
Email: orderlit@onsemi.com

N. American Technical Support: 800-282-9855 Toll Free USA/Canada
Europe, Middle East and Africa Technical Support:
Phone: 421 33 790 2910
Japan Customer Focus Center
Phone: 81-3-5773-3850

ON Semiconductor Website: www.onsemi.com
Order Literature: <http://www.onsemi.com/orderlit>

For additional information, please contact your local Sales Representative