

# MC1413, MC1413B, NCV1413B

## High Voltage, High Current Darlington Transistor Arrays

The seven NPN Darlington connected transistors in these arrays are well suited for driving lamps, relays, or printer hammers in a variety of industrial and consumer applications. Their high breakdown voltage and internal suppression diodes insure freedom from problems associated with inductive loads. Peak inrush currents to 500 mA permit them to drive incandescent lamps.

The MC1413, B with a 2.7 kΩ series input resistor is well suited for systems utilizing a 5.0 V TTL or CMOS Logic.

### Features

- Pb-Free Packages are Available\*
- NCV Prefix for Automotive and Other Applications Requiring Site and Control Changes

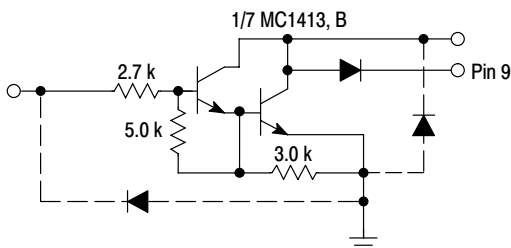

Figure 1. Representative Schematic Diagram

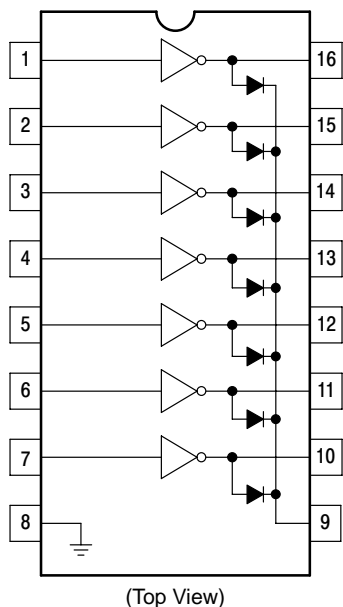

Figure 2. PIN CONNECTIONS

\*For additional information on our Pb-Free strategy and soldering details, please download the ON Semiconductor Soldering and Mounting Techniques Reference Manual, SOLDERRM/D.



ON Semiconductor®

<http://onsemi.com>

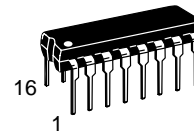

PDIP-16  
P SUFFIX  
CASE 648

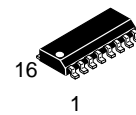

SOIC-16  
D SUFFIX  
CASE 751B

### ORDERING INFORMATION

Device	Package	Shipping†
MC1413D	SOIC-16	48 Units/Rail
MC1413DG	SOIC-16 (Pb-Free)	48 Units/Tube
MC1413DR2	SOIC-16	2500 Tape & Reel
MC1413DR2G	SOIC-16 (Pb-Free)	2500 Tape & Reel
MC1413P	PDIP-16	25 Units/Rail
MC1413PG	PDIP-16 (Pb-Free)	25 Units/Rail
MC1413BD	SOIC-16	48 Units/Rail
MC1413BDG	SOIC-16 (Pb-Free)	48 Units/Rail
MC1413BDR2	SOIC-16	2500 Tape & Reel
MC1413BDR2G	SOIC-16 (Pb-Free)	2500 Tape & Reel
MC1413BP	PDIP-16	25 Units/Rail
MC1413BPG	PDIP-16 (Pb-Free)	25 Units/Rail
NCV1413BDR2	SOIC-16	2500 Tape & Reel
NCV1413BDR2G	SOIC-16 (Pb-Free)	2500 Tape & Reel

†For information on tape and reel specifications, including part orientation and tape sizes, please refer to our Tape and Reel Packaging Specifications Brochure, BRD8011/D.

### DEVICE MARKING INFORMATION

See general marking information in the device marking section on page 5 of this data sheet.

## MC1413, MC1413B, NCV1413B

**MAXIMUM RATINGS** ( $T_A = 25^\circ\text{C}$ , and rating apply to any one device in the package, unless otherwise noted.)

Rating	Symbol	Value	Unit
Output Voltage	$V_O$	50	V
Input Voltage	$V_I$	30	V
Collector Current – Continuous	$I_C$	500	mA
Base Current – Continuous	$I_B$	25	mA
Operating Ambient Temperature Range MC1413 MC1413B NCV1413B	$T_A$	-20 to +85 -40 to +85 -40 to +125	$^\circ\text{C}$
Storage Temperature Range	$T_{stg}$	-55 to +150	$^\circ\text{C}$
Junction Temperature	$T_J$	150	$^\circ\text{C}$
Thermal Resistance, Junction-to-Ambient Case 648, P Suffix Case 751B, D Suffix	$R_{\theta JA}$	67 100	$^\circ\text{C/W}$
Thermal Resistance, Junction-to-Case Case 648, P Suffix Case 751B, D Suffix	$R_{\theta JC}$	22 20	$^\circ\text{C/W}$
Electrostatic Discharge Sensitivity (ESD) Human Body Model (HBM) Machine Model (MM) Charged Device Model (CDM)	ESD	2000 400 1500	V

Stresses exceeding Maximum Ratings may damage the device. Maximum Ratings are stress ratings only. Functional operation above the Recommended Operating Conditions is not implied. Extended exposure to stresses above the Recommended Operating Conditions may affect device reliability.

# MC1413, MC1413B, NCV1413B

## ELECTRICAL CHARACTERISTICS (T<sub>A</sub> = 25°C, unless otherwise noted)

Characteristic		Symbol	Min	Typ	Max	Unit
Output Leakage Current (V <sub>O</sub> = 50 V, T <sub>A</sub> = +85°C) (V <sub>O</sub> = 50 V, T <sub>A</sub> = +25°C)	All Types All Types	I <sub>CEX</sub>	– –	– –	100 50	μA
Collector–Emitter Saturation Voltage (I <sub>C</sub> = 350 mA, I <sub>B</sub> = 500 μA) (I <sub>C</sub> = 200 mA, I <sub>B</sub> = 350 μA) (I <sub>C</sub> = 100 mA, I <sub>B</sub> = 250 μA)	All Types All Types All Types	V <sub>CE(sat)</sub>	– – –	1.1 0.95 0.85	1.6 1.3 1.1	V
Input Current – On Condition (V <sub>I</sub> = 3.85 V)	MC1413, B	I <sub>I(on)</sub>	–	0.93	1.35	mA
Input Voltage – On Condition (V <sub>CE</sub> = 2.0 V, I <sub>C</sub> = 200 mA) (V <sub>CE</sub> = 2.0 V, I <sub>C</sub> = 250 mA) (V <sub>CE</sub> = 2.0 V, I <sub>C</sub> = 300 mA)	MC1413, B MC1413, B MC1413, B	V <sub>I(on)</sub>	– – –	– – –	2.4 2.7 3.0	V
Input Current – Off Condition (I <sub>C</sub> = 500 μA, T <sub>A</sub> = 85°C)	All Types	I <sub>I(off)</sub>	50	100	–	μA
DC Current Gain (V <sub>CE</sub> = 2.0 V, I <sub>C</sub> = 350 mA)		h <sub>FE</sub>	1000	–	–	–
Input Capacitance		C <sub>I</sub>	–	15	30	pF
Turn–On Delay Time (50% E <sub>I</sub> to 50% E <sub>O</sub> )		t <sub>on</sub>	–	0.25	1.0	μs
Turn–Off Delay Time (50% E <sub>I</sub> to 50% E <sub>O</sub> )		t <sub>off</sub>	–	0.25	1.0	μs
Clamp Diode Leakage Current (V <sub>R</sub> = 50 V)	T <sub>A</sub> = +25°C T <sub>A</sub> = +85°C	I <sub>R</sub>	– –	– –	50 100	μA
Clamp Diode Forward Voltage (I <sub>F</sub> = 350 mA)		V <sub>F</sub>	–	1.5	2.0	V

NOTE: NCV1413B T<sub>low</sub> = –40°C, T<sub>high</sub> = +125°C. Guaranteed by design. NCV prefix is for automotive and other applications requiring site and change control.

# MC1413, MC1413B, NCV1413B

TYPICAL PERFORMANCE CURVES -  $T_A = 25^\circ\text{C}$

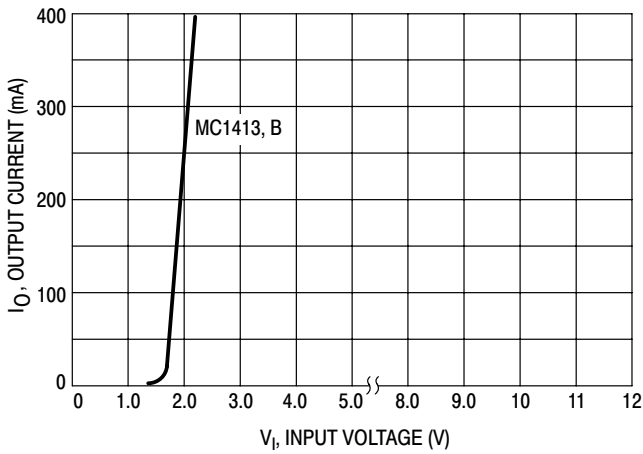

Figure 3. Output Current versus Input Voltage

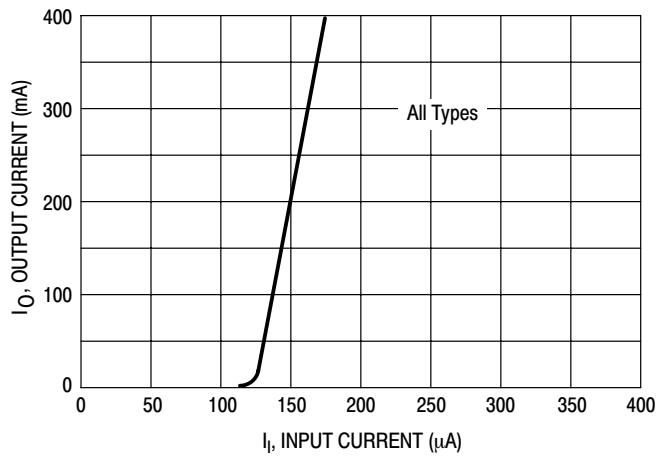

Figure 4. Output Current versus Input Current

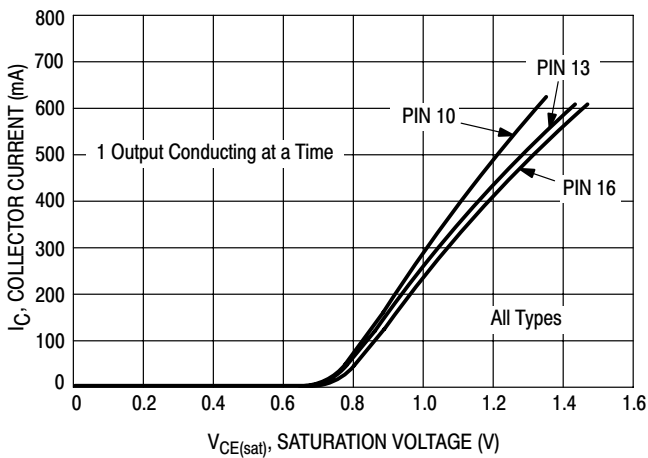

Figure 5. Typical Output Characteristics

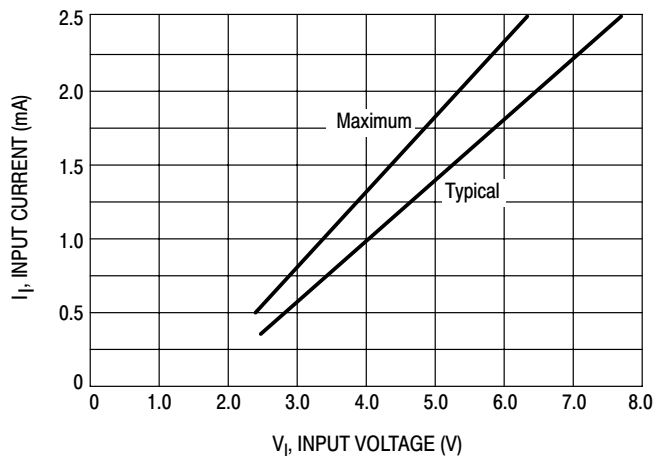

Figure 6. Input Characteristics - MC1413, B

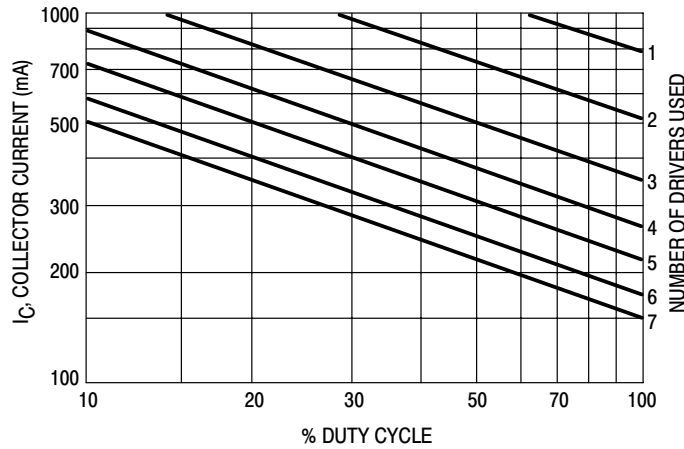
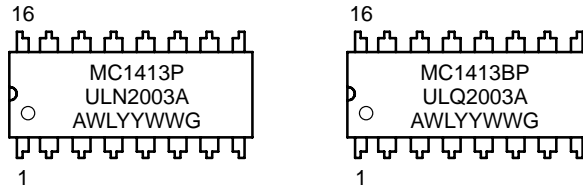

Figure 7. Maximum Collector Current versus Duty Cycle (and Number of Drivers in Use)

# MC1413, MC1413B, NCV1413B

## MARKING DIAGRAMS

### PDIP-16 P SUFFIX CASE 648



### SOIC-16 D SUFFIX CASE 751B

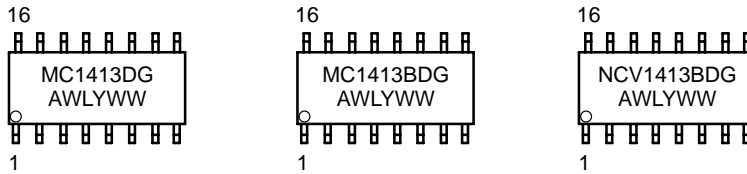

A = Assembly Location  
WL = Wafer Lot  
YY, Y = Year  
WW = Work Week  
G = Pb-Free Package

# MC1413, MC1413B, NCV1413B

## PACKAGE DIMENSIONS

PDIP-16  
P SUFFIX  
CASE 648-08  
ISSUE T

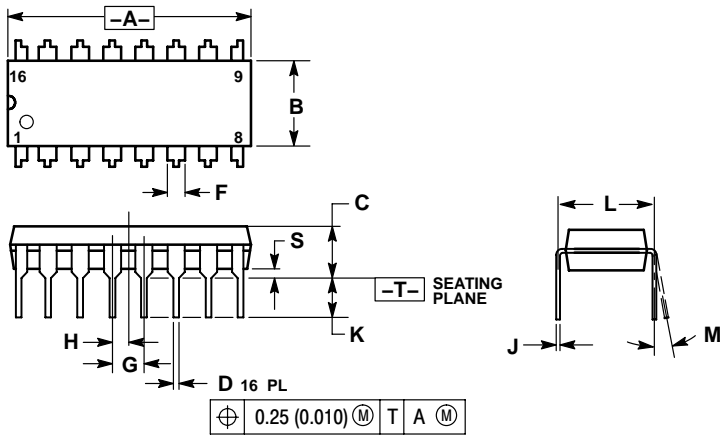

NOTES:

1. DIMENSIONING AND TOLERANCING PER ANSI Y14.5M, 1982.
2. CONTROLLING DIMENSION: INCH.
3. DIMENSION L TO CENTER OF LEADS WHEN FORMED PARALLEL.
4. DIMENSION B DOES NOT INCLUDE MOLD FLASH.
5. ROUNDED CORNERS OPTIONAL.

DIM	INCHES		MILLIMETERS	
	MIN	MAX	MIN	MAX
A	0.740	0.770	18.80	19.55
B	0.250	0.270	6.35	6.85
C	0.145	0.175	3.69	4.44
D	0.015	0.021	0.39	0.53
F	0.040	0.70	1.02	1.77
G	0.100 BSC		2.54 BSC	
H	0.050 BSC		1.27 BSC	
J	0.008	0.015	0.21	0.38
K	0.110	0.130	2.80	3.30
L	0.295	0.305	7.50	7.74
M	0°	10°	0°	10°
S	0.020	0.040	0.51	1.01

# MC1413, MC1413B, NCV1413B

## PACKAGE DIMENSIONS

SOIC-16  
D SUFFIX  
CASE 751B-05  
ISSUE J

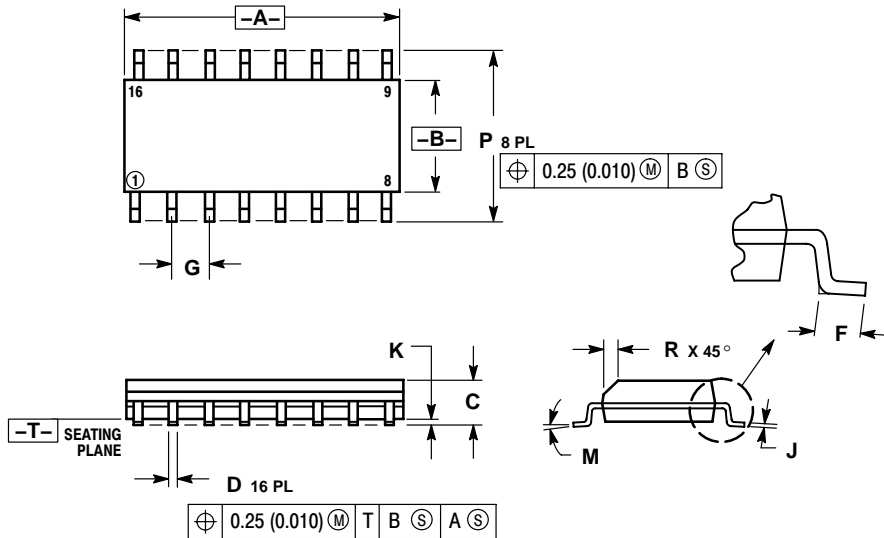

- NOTES:
1. DIMENSIONING AND TOLERANCING PER ANSI Y14.5M, 1982.
  2. CONTROLLING DIMENSION: MILLIMETER.
  3. DIMENSIONS A AND B DO NOT INCLUDE MOLD PROTRUSION.
  4. MAXIMUM MOLD PROTRUSION 0.15 (0.006) PER SIDE.
  5. DIMENSION D DOES NOT INCLUDE DAMBAR PROTRUSION. ALLOWABLE DAMBAR PROTRUSION SHALL BE 0.127 (0.005) TOTAL IN EXCESS OF THE D DIMENSION AT MAXIMUM MATERIAL CONDITION.

DIM	MILLIMETERS		INCHES	
	MIN	MAX	MIN	MAX
A	9.80	10.00	0.386	0.393
B	3.80	4.00	0.150	0.157
C	1.35	1.75	0.054	0.068
D	0.35	0.49	0.014	0.019
F	0.40	1.25	0.016	0.049
G	1.27 BSC		0.050 BSC	
J	0.19	0.25	0.008	0.009
K	0.10	0.25	0.004	0.009
M	0°	7°	0°	7°
P	5.80	6.20	0.229	0.244
R	0.25	0.50	0.010	0.019

# MC1413, MC1413B, NCV1413B

**ON Semiconductor** and  are registered trademarks of Semiconductor Components Industries, LLC (SCILLC). SCILLC reserves the right to make changes without further notice to any products herein. SCILLC makes no warranty, representation or guarantee regarding the suitability of its products for any particular purpose, nor does SCILLC assume any liability arising out of the application or use of any product or circuit, and specifically disclaims any and all liability, including without limitation special, consequential or incidental damages. "Typical" parameters which may be provided in SCILLC data sheets and/or specifications can and do vary in different applications and actual performance may vary over time. All operating parameters, including "Typicals" must be validated for each customer application by customer's technical experts. SCILLC does not convey any license under its patent rights nor the rights of others. SCILLC products are not designed, intended, or authorized for use as components in systems intended for surgical implant into the body, or other applications intended to support or sustain life, or for any other application in which the failure of the SCILLC product could create a situation where personal injury or death may occur. Should Buyer purchase or use SCILLC products for any such unintended or unauthorized application, Buyer shall indemnify and hold SCILLC and its officers, employees, subsidiaries, affiliates, and distributors harmless against all claims, costs, damages, and expenses, and reasonable attorney fees arising out of, directly or indirectly, any claim of personal injury or death associated with such unintended or unauthorized use, even if such claim alleges that SCILLC was negligent regarding the design or manufacture of the part. SCILLC is an Equal Opportunity/Affirmative Action Employer. This literature is subject to all applicable copyright laws and is not for resale in any manner.

## PUBLICATION ORDERING INFORMATION

### LITERATURE FULFILLMENT:

Literature Distribution Center for ON Semiconductor  
P.O. Box 5163, Denver, Colorado 80217 USA  
**Phone:** 303-675-2175 or 800-344-3860 Toll Free USA/Canada  
**Fax:** 303-675-2176 or 800-344-3867 Toll Free USA/Canada  
**Email:** [orderlit@onsemi.com](mailto:orderlit@onsemi.com)

**N. American Technical Support:** 800-282-9855 Toll Free  
USA/Canada  
**Europe, Middle East and Africa Technical Support:**  
Phone: 421 33 790 2910  
**Japan Customer Focus Center**  
Phone: 81-3-5773-3850

**ON Semiconductor Website:** [www.onsemi.com](http://www.onsemi.com)

**Order Literature:** <http://www.onsemi.com/orderlit>

For additional information, please contact your local  
Sales Representative