

2.4-2.5 GHz / 4.9-5.8 GHz Dual-Band Power Amplifier

SST13LP01



Preliminary Specifications

FEATURES:

- **High Gain:**
 - Typically 28 dB gain across 2.4-2.5 GHz over temperature 0°C to +85°C
 - Typically 30-33 dB gain across 4.9-5.8 GHz over temperature 0°C to +85°C
- **High linear output power:**
 - >29 dBm P1dB across 2.4-2.5 GHz (Exceeding maximum rating of average output power, never measure with CW source! Pulsed single-tone source with <50% duty cycle is recommended.)
 - Meets 802.11g OFDM ACPR requirement up to 23 dBm
 - Added EVM~4% up to 21 dBm for 54 Mbps 802.11g signal
 - Meets 802.11b ACPR requirement up to 23 dBm
 - ~28 dBm P1dB (Pulsed single-tone signal) across 4.9~5.8 GHz
 - Meets 802.11a OFDM ACPR requirement up to 22 dBm over whole band
 - Added EVM~4% up to 20 dBm for 54 Mbps 802.11a signal
- **High power-added efficiency/Low operating current for both 802.11a/b/g applications**
 - ~24%/250 mA @ P_{OUT} = 23 dBm for 802.11g
 - ~23%/260 mA @ P_{OUT} = 23 dBm for 802.11b
 - ~9.5%/320 mA @ P_{OUT} = 20 dBm for 802.11a
- **Built-in Ultra-low I_{REF} power-up/down control**
 - I_{REF} <3 mA
- **Low idle current**
 - ~70 mA I_{CQ} (802.11b/g)
 - ~170 mA I_{CQ} (802.11a)
- **High-speed power-up/down**
 - Turn on/off time (10%~90%) <100 ns
 - Typical power-up/down delay with driver delay included <200 ns
- **High temperature stability**
 - ~1 dB gain/power variation between 0°C to +85°C across 2.4~2.5 GHz
 - ~3.5/1.5 dB gain/max linear power variation between 0°C to +85°C across 4.9~5.8 GHz
 - ~1 dB detector variation over 0°C to +85°C
- **Low shut-down current (< 0.1 μA)**
- **On-chip power detection**
- **20 dB dynamic range on-chip power detection**
- **Simple input/output matching**
- **Packages available**
 - 24-contact WQFN (4mm x 4mm)
 - Non-Pb (lead-free) packages available

APPLICATIONS:

- **WLAN (IEEE 802.11a/g/b)**
- **Japanese WLAN**
- **HyperLAN2**
- **Multimedia**
- **Home RF**
- **Cordless phones**

PRODUCT DESCRIPTION

The SST13LP01 is a high-gain, high-performance, dual-band power amplifier IC based on the highly-reliable InGaP/GaAs HBT technology.

The SST13LP01 device can be easily configured for high-power applications with superb power-added efficiency while operating over the 802.11a/b/g frequency band for U.S., European, and Japanese markets (2.4-2.5 GHz and 4.9-5.8 GHz).

The SST13LP01 has excellent linearity, typically ~4% added EVM at 21 dBm output power which is essential for 54 Mbps 802.11g operation while meeting 802.11g spectrum mask at 23 dBm and 802.11b spectrum mask at 23 dBm. For 802.11a operation, the SST13LP01 has demonstrated typically ~4% added EVM at 20 dBm output power while meeting 802.11a spectrum mask at 22 dBm. The

SST13LP01 also has wide-range (>20 dB), temperature-stable (~1 dB over 85°C), single-ended/differential power detectors which lower users' cost on power control.

The power amplifier IC also features easy board-level usage along with high-speed power-up/down control. Ultra-low reference current (total I_{REF} <3 mA) makes the SST13LP01 controllable by an on/off switching signal directly from the baseband chip. These features, coupled with low operating current, make the SST13LP01 ideal for the final stage power amplification in both battery-powered 802.11a/b/g WLAN transmitter and access point applications.

The SST13LP01 is offered in a 24-contact WQFN package. See Figure 1 for pin assignments and Table 1 for pin descriptions.



2.4-2.5 GHz / 4.9-5.8 GHz Dual-Band Power Amplifier SST13LP01

Preliminary Specifications

FUNCTIONAL BLOCKS

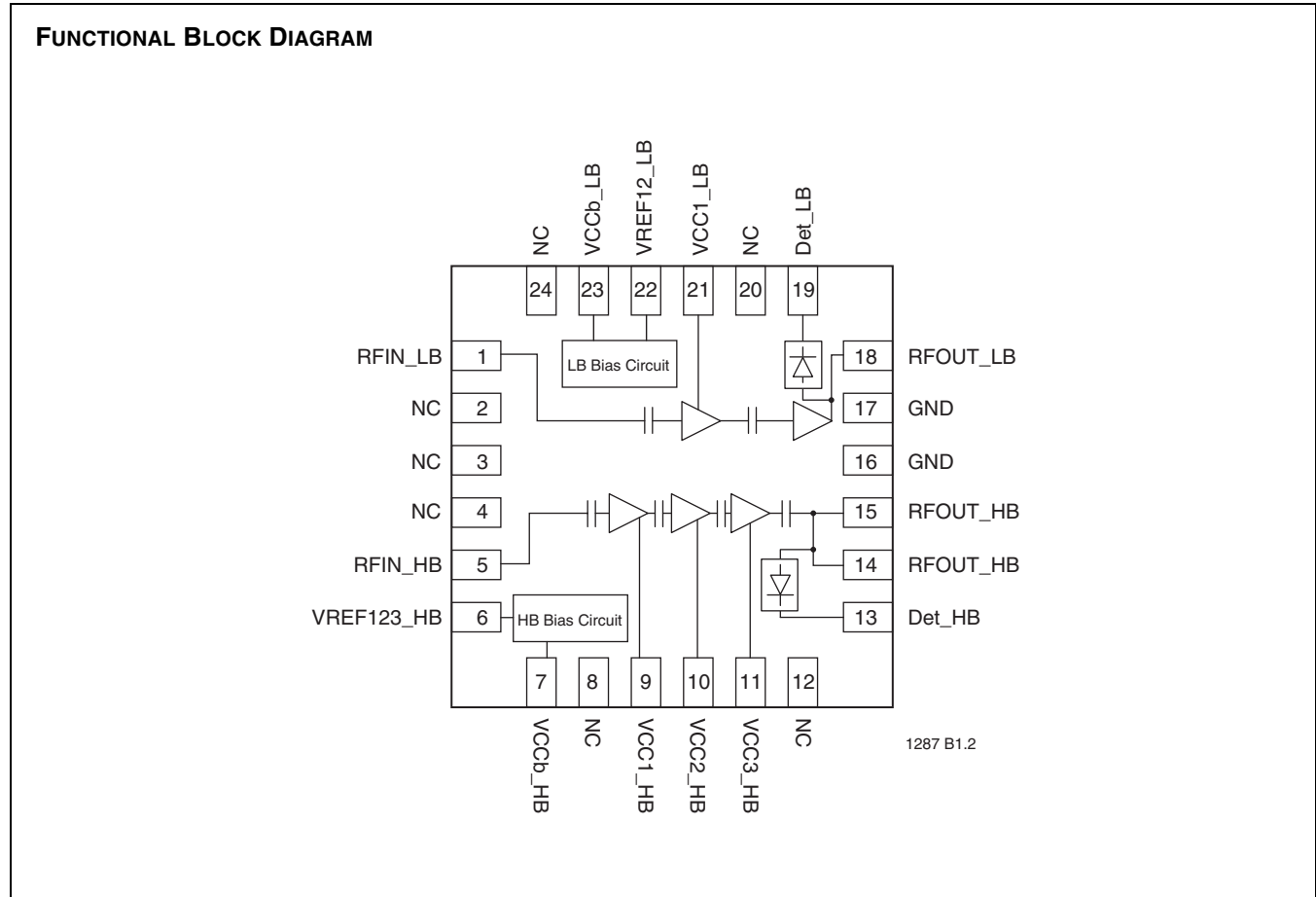

PIN ASSIGNMENTS

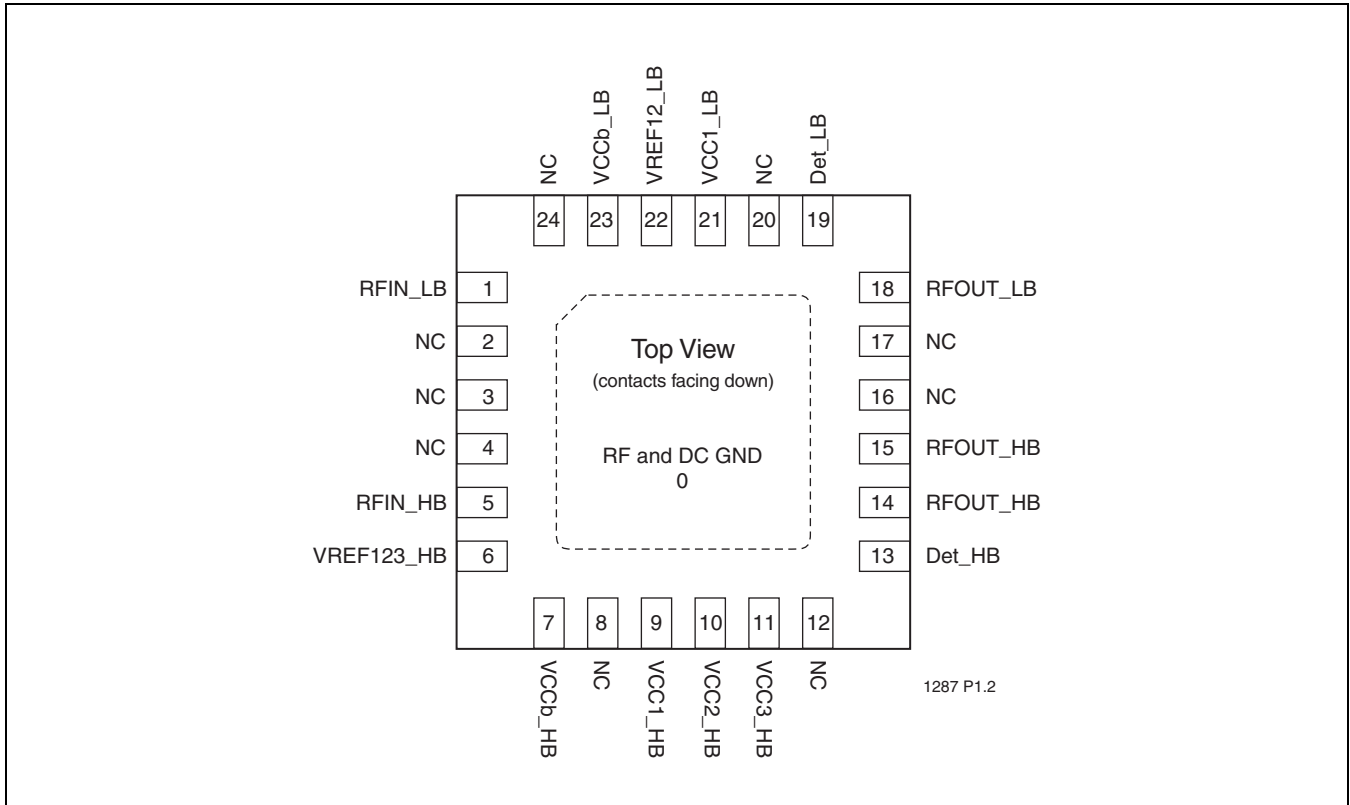

FIGURE 1: PIN ASSIGNMENTS FOR 16-CONTACT WQFN



2.4-2.5 GHz / 4.9-5.8 GHz Dual-Band Power Amplifier SST13LP01

Preliminary Specifications

PIN DESCRIPTIONS

TABLE 1: PIN DESCRIPTION

Symbol	Pin No.	Pin Name	Type	Function
GND	0	Ground		Ground pad
RFIN_LB	1		I	RF input for Low Band, DC decoupled
NC	2	No Connection		Unconnected pin
NC	3	No Connection		Unconnected pin
NC	4	No Connection		Unconnected pin
RFIN_HB	5		I	RF input for High Band, DC decoupled
VREF123_HB	6		PWR	1st, 2nd, and 3rd stage current control for High Band
VCCb_HB	7		PWR	Power Supply, Bias circuit for High Band
NC	8	No Connection		Unconnected pin
VCC1_HB	9	Power Supply	PWR	1st stage Power supply for High Band
VCC2_HB	10	Power Supply	PWR	2nd stage Power supply for High Band
VCC3_HB	11	Power Supply	PWR	3rd stage Power supply for High Band
NC	12	No Connection		Unconnected pin
Det_HB	13		O	Detector Voltage Output for High Band
RFOUT_HB	14		O	RF output for High Band, DC decoupled
RFOUT_HB	15		O	RF output for High Band, DC decoupled
NC	16	No Connection		Unconnected pin
NC	17	No Connection		Unconnected pin
RFOUT_LB	18		O	RF output for Low Band, DC decoupled
Det_LB	19		O	Detector Voltage Output for Low Band
NC	20	No Connection		Unconnected pin
VCC1_LB	21	Power Supply	PWR	1st stage Power supply for Low Band
VREF12_LB	22		PWR	Power Supply, Bias circuit for Low Band
VCCb_LB	23		PWR	Current Control for Low Band
NC	24	No Connection		Unconnected pin

T1.1 1287



2.4-2.5 GHz / 4.9-5.8 GHz Dual-Band Power Amplifier SST13LP01

Preliminary Specifications

ELECTRICAL SPECIFICATIONS

The AC and DC specifications for the power amplifier interface signals. Refer to Table 2 for the DC voltage and current specifications. Refer to Figures 2 through 28 for the RF performance.

Absolute Maximum Stress Ratings (Applied conditions greater than those listed under “Absolute Maximum Stress Ratings” may cause permanent damage to the device. This is a stress rating only and functional operation of the device at these conditions or conditions greater than those defined in the operational sections of this data sheet is not implied. Exposure to absolute maximum stress rating conditions may affect device reliability.)

Supply Voltage at pins 7, 9, 10, 11, 21, and 23 (V_{CC})	-0.3V to +4.0V
Reference Voltage at pins 6 and 22 (V_{REF})	-0.3V to +3.3V
DC supply current (I_{CC})	500 mA
Operating Temperature (T_A)	-40°C to +85°C
Storage Temperature (T_{STG})	-40°C to +120°C
Maximum Junction Temperature (T_J)	+150°C
Surface Mount Solder Reflow Temperature	260°C for 10 seconds

OPERATING RANGE

Range	Ambient Temp	V_{CC}
Industrial	-40°C to +85°C	3.3V



2.4-2.5 GHz / 4.9-5.8 GHz Dual-Band Power Amplifier SST13LP01

Preliminary Specifications

For 802.11b/g Operation

TABLE 2: DC ELECTRICAL CHARACTERISTICS

Symbol	Parameter	Min.	Typ	Max.	Unit	Test Conditions
V _{CC}	Supply Voltage at pin 21	3.0	3.3	3.6	V	
I _{CC}	Supply Current for 802.11g, 23 dBm for 802.11b, 23 dBm		250 260		mA mA	
I _{CQ}	Idle current for 802.11g to meet EVM<4% @ 21 dBm		70		mA	
I _{OFF}	Shut down current			0.1	μA	
V _{REG}	Reference Voltage at pin 22, with 105Ω resistor	2.75	2.85	2.95	V	

T2.1 1287

TABLE 3: AC ELECTRICAL CHARACTERISTICS FOR CONFIGURATION

Symbol	Parameter	Min.	Typ	Max.	Unit
F _{L-U}	Frequency range	2400		2485	MHz
G	Small signal gain	27	28	29	dB
G _{VAR1}	Gain variation over band (2400~2485 MHz)			±0.5	dB
G _{VAR2}	Gain ripple over channel (20 MHz)		0.2		dB
ACPR	Meet 11b spectrum mask	22	23		dBm
	Meet 11g OFDM 54 MBPS spectrum mask	22	23		dBm
Added EVM	P _{OUT} = 22 dBm output with 54 MBPS 11g OFDM signal		4		%
2f, 3f, 4f, 5f	Harmonics at 22 dBm, without trapping capacitors			-40	dBc

T3.1 1287



2.4-2.5 GHz / 4.9-5.8 GHz Dual-Band Power Amplifier SST13LP01

Preliminary Specifications

For 802.11a Operation

TABLE 4: DC ELECTRICAL CHARACTERISTICS

Symbol	Parameter	Min.	Typ	Max.	Unit	Test Conditions
V_{CC}	Supply Voltage at pins 7, 9, 10, 11	3.0	3.3	3.6	V	
I_{CC}	Supply Current for 802.11a, 21 dBm at $V_{CC} = 3.3V$	300		340	mA	
I_{CQ}	Idle current		170		mA	
I_{OFF}	Shut down current		<0.1		μA	
V_{REG}	Reference Voltage at pin 6, with 0Ω resistor	2.8	2.9	3.0	V	
Total I_{REG}	Total Reference Current		2	3	mA	

T4.1 1287

TABLE 5: AC ELECTRICAL CHARACTERISTICS FOR CONFIGURATION

Symbol	Parameter	Min.	Typ	Max.	Unit
F_{L-U}	Frequency range	4900		5800	MHz
G	Linear gain across 4.9-5.9 GHz, 0°C to +85°C	28		34	dB
G_{VAR}	Gain variation over band (4.9-5.8 MHz)		4		dB
	Gain variation over band (4.9-5.38 MHz)		2		dB
	Gain variation over band (5.7-5.8 MHz)		0.5		dB
	Gain variation over channel (20 MHz)		0.2		dB
Linearity	Added EVM @ $P_{OUT} = 20$ dBm with 54 MBPS 11a OFDM signal when operating at 3.3V V_{CC}		4		%
	Output power level with 802.11a mask compliance across 4.9-5.8 GHz	21	22		dBm
2f, 3f, 4f, 5f	Harmonics at 22 dBm			-40	dBc

T5.1 1287



2.4-2.5 GHz / 4.9-5.8 GHz Dual-Band Power Amplifier SST13LP01

Preliminary Specifications

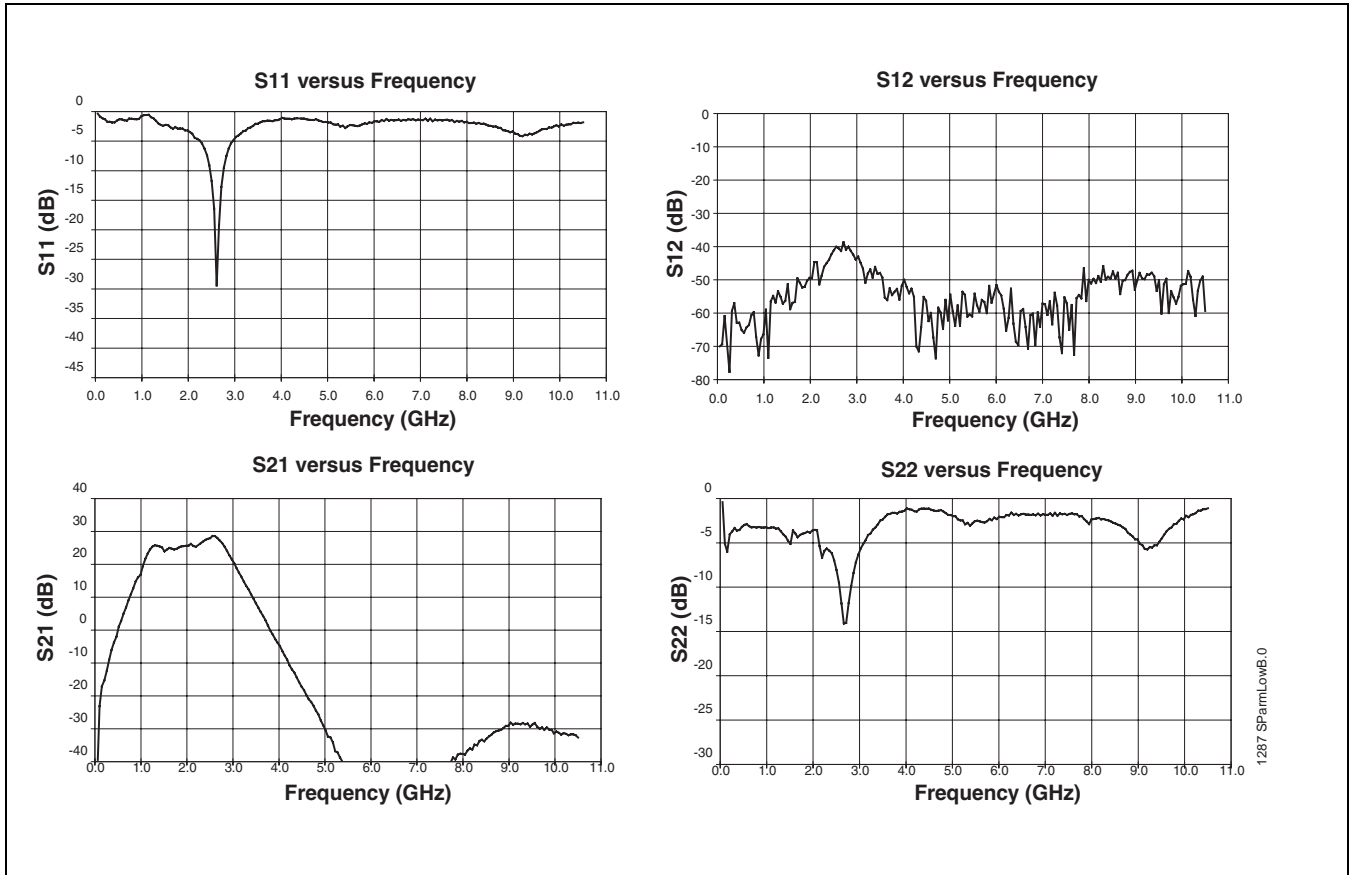

FIGURE 2: LOW BAND S-PARAMETERS

2.4-2.5 GHz / 4.9-5.8 GHz Dual-Band Power Amplifier SST13LP01



Preliminary Specifications

TYPICAL PERFORMANCE CHARACTERISTICS FOR 802.11B/G

TEST CONDITIONS: $V_{CC} = 3.3V$, $V_{REG_LB} = 2.85V$, $T_A = 25^\circ C$, 54 MPBS 802.11G OFDM SIGNAL

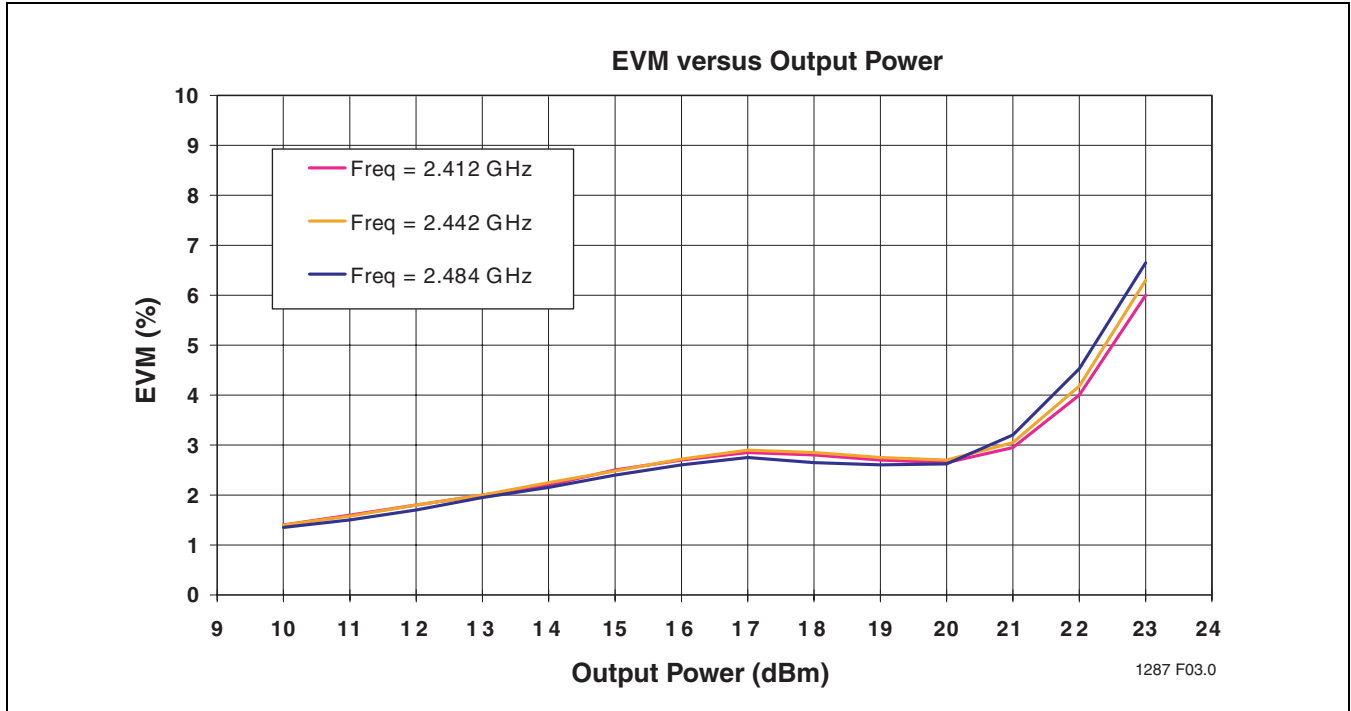

FIGURE 3: LOW BAND EVM VERSUS OUTPUT POWER

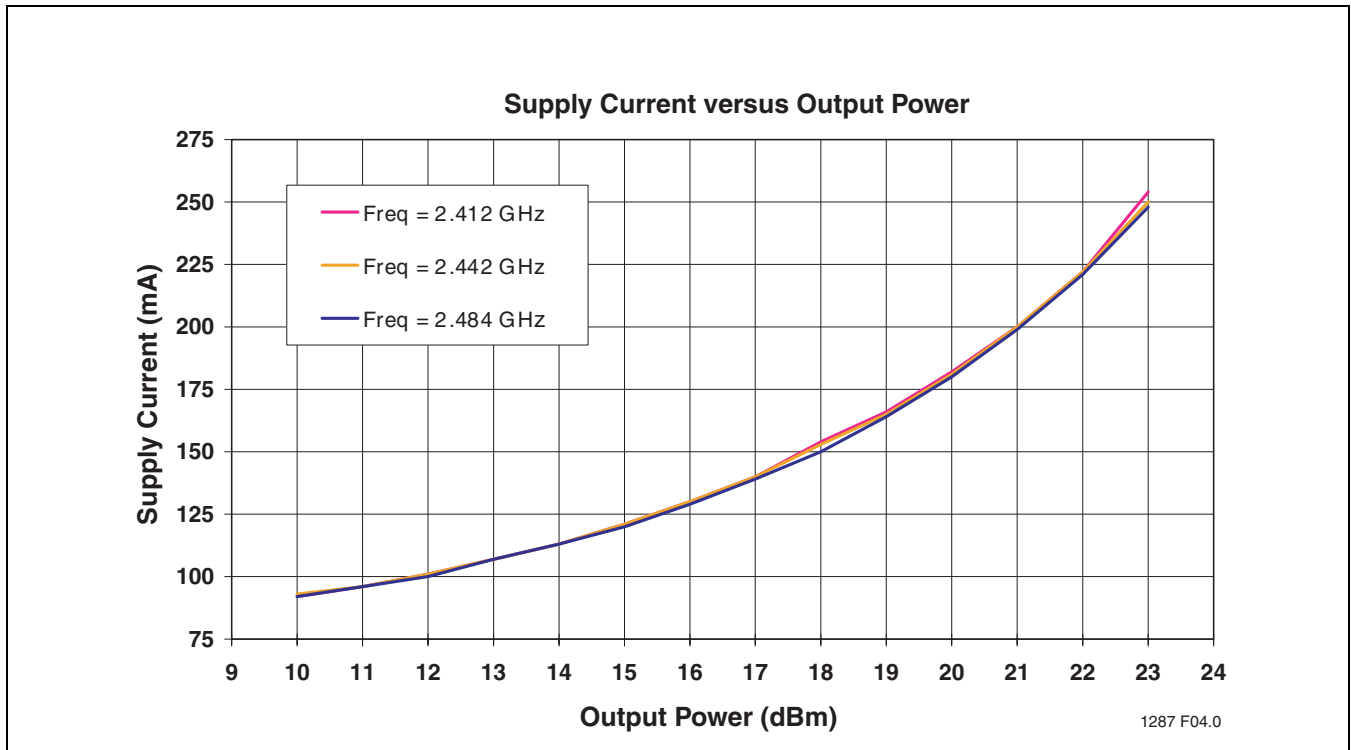

FIGURE 4: LOW BAND POWER SUPPLY CURRENT VERSUS OUTPUT POWER



Preliminary Specifications

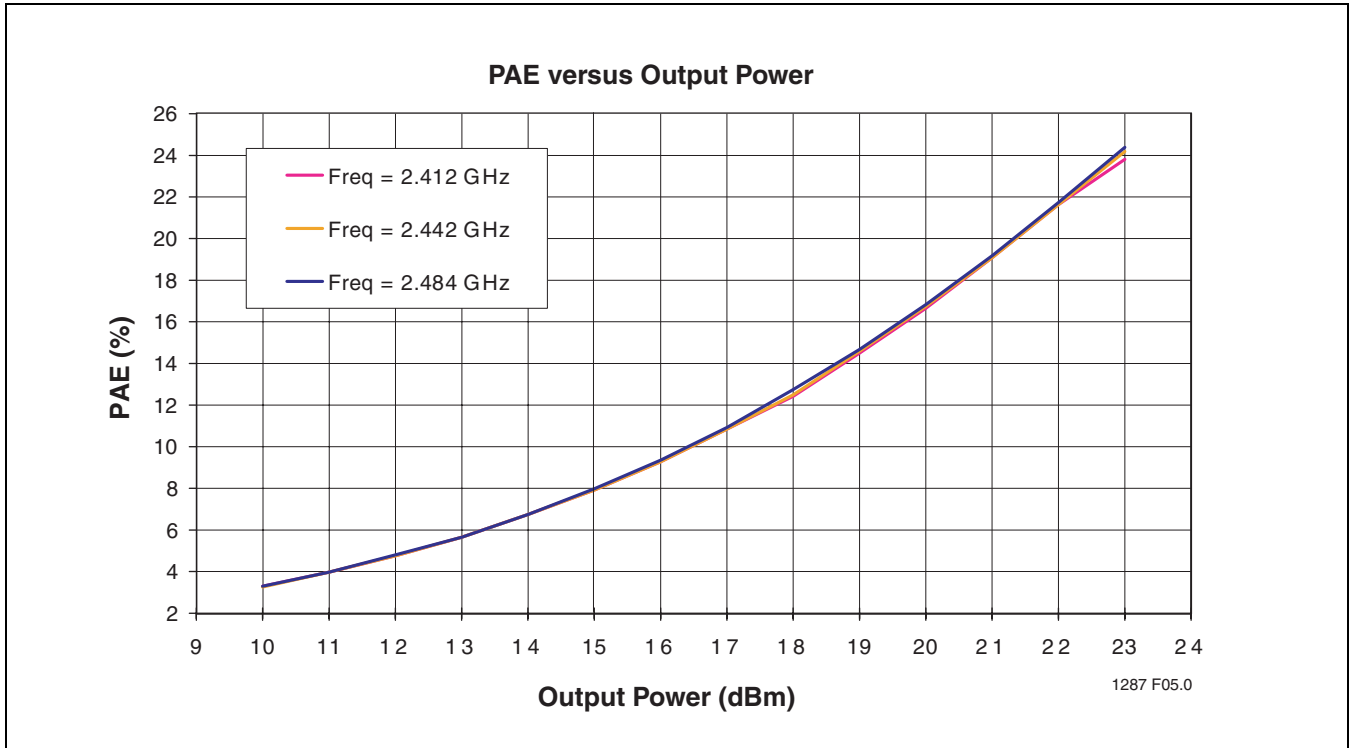

FIGURE 5: LOW BAND PAE VERSUS OUTPUT POWER

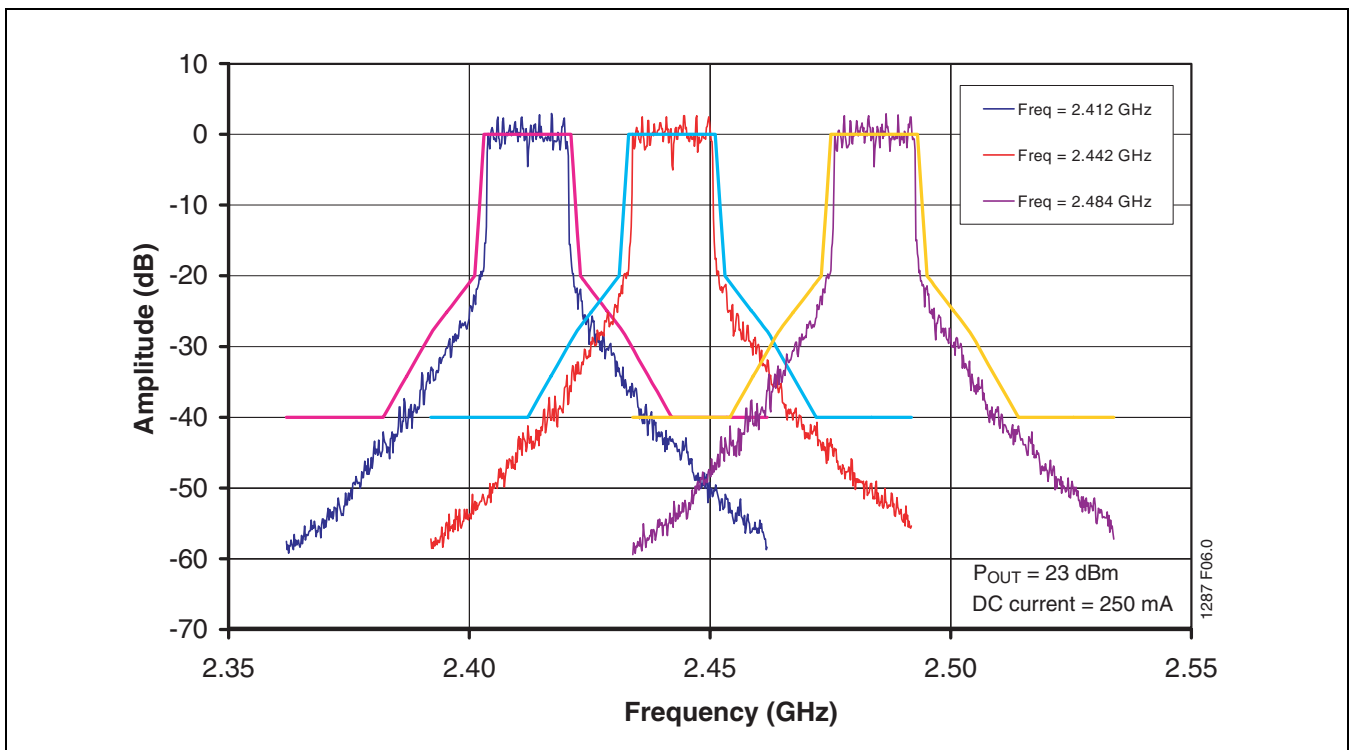

FIGURE 6: LOW BAND 802.11G SPECTRUM MASK AT 23 dBm WITH DC CURRENT AT 250 MA

2.4-2.5 GHz / 4.9-5.8 GHz Dual-Band Power Amplifier SST13LP01



Preliminary Specifications

TYPICAL PERFORMANCE CHARACTERISTICS

TEST CONDITIONS: $V_{CC} = 3.3V$, $V_{REG_LB} = 2.85V$, $T_A = 25^\circ C$, 1 MPBS 802.11B CCK SIGNAL

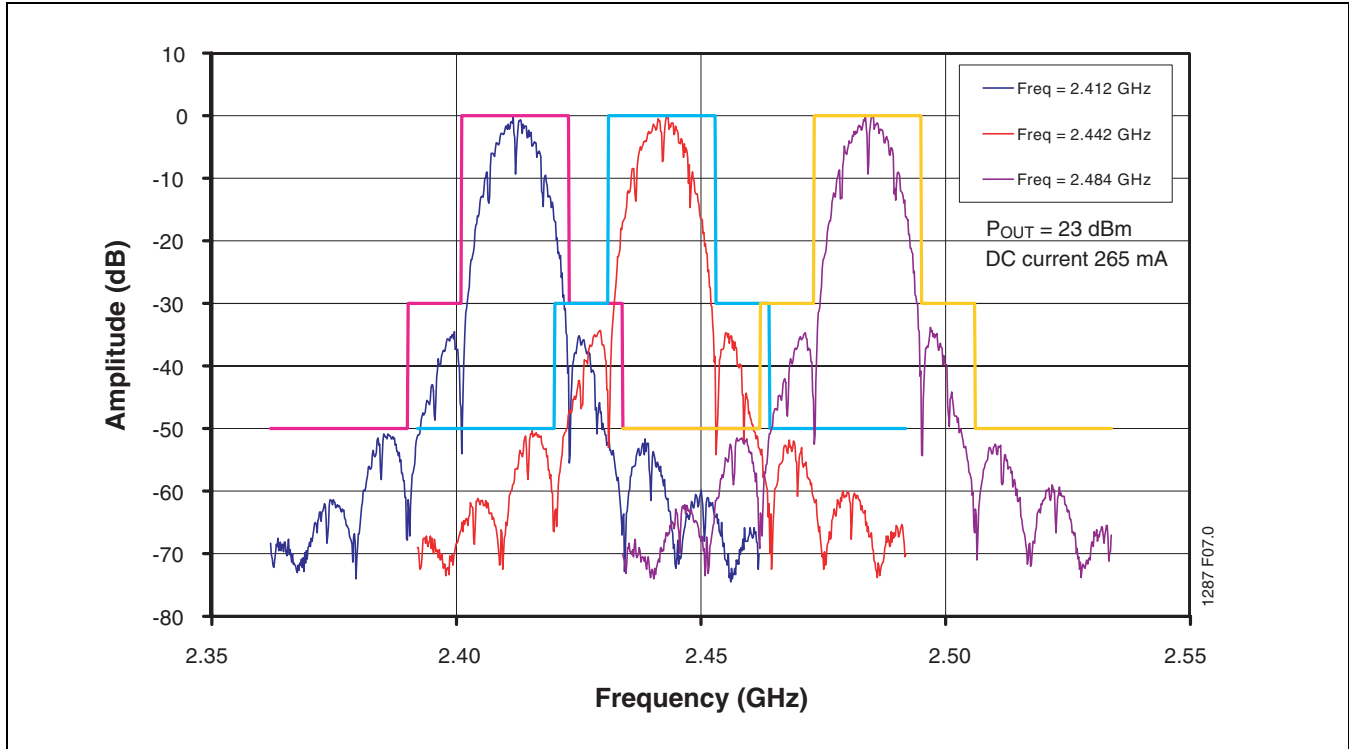

FIGURE 7: LOW BAND 802.11B SPECTRUM MASK AT 23 dBM WITH DC CURRENT OF 265 MA



Preliminary Specifications

LOW BAND POWER DETECTOR CHARACTERISTICS

TEST CONDITIONS: $V_{CC} = 3.3V$, $V_{REG_LB} = 2.85V$, $T_A = 25^\circ C$, 54 MPBS 802.11G OFDM SIGNAL

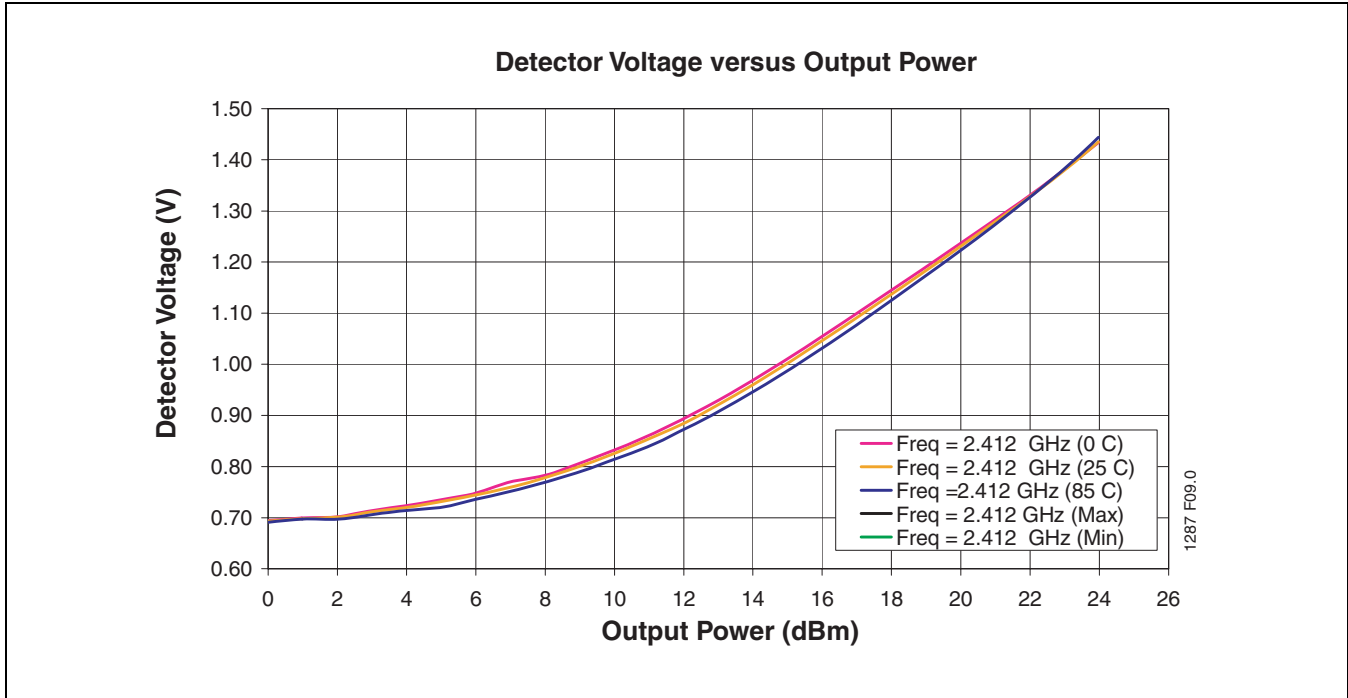

FIGURE 8: LOW BAND CH1 DETECTOR CHARACTERISTICS OVER TEMPERATURE WITH 2:1 OUTPUT VSWR ALL PHASES

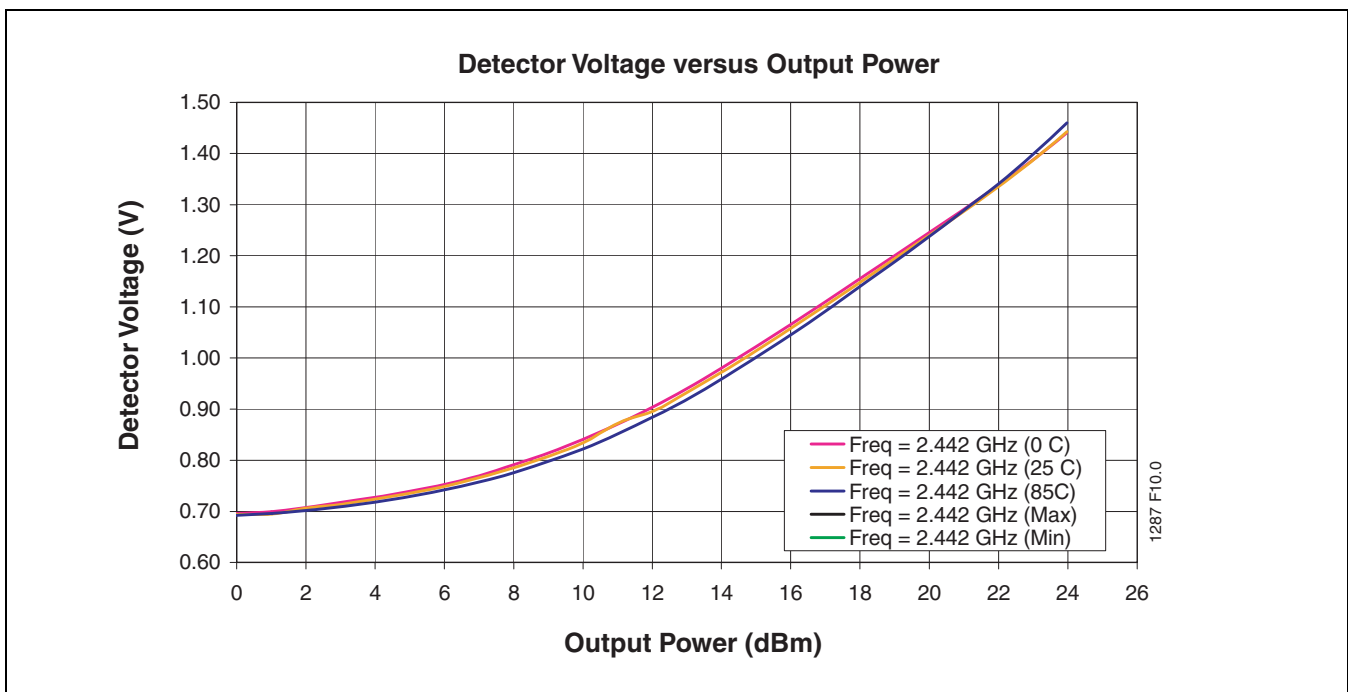

FIGURE 9: LOW BAND CH7 DETECTOR CHARACTERISTICS OVER TEMPERATURE WITH 2:1 OUTPUT VSWR ALL PHASES

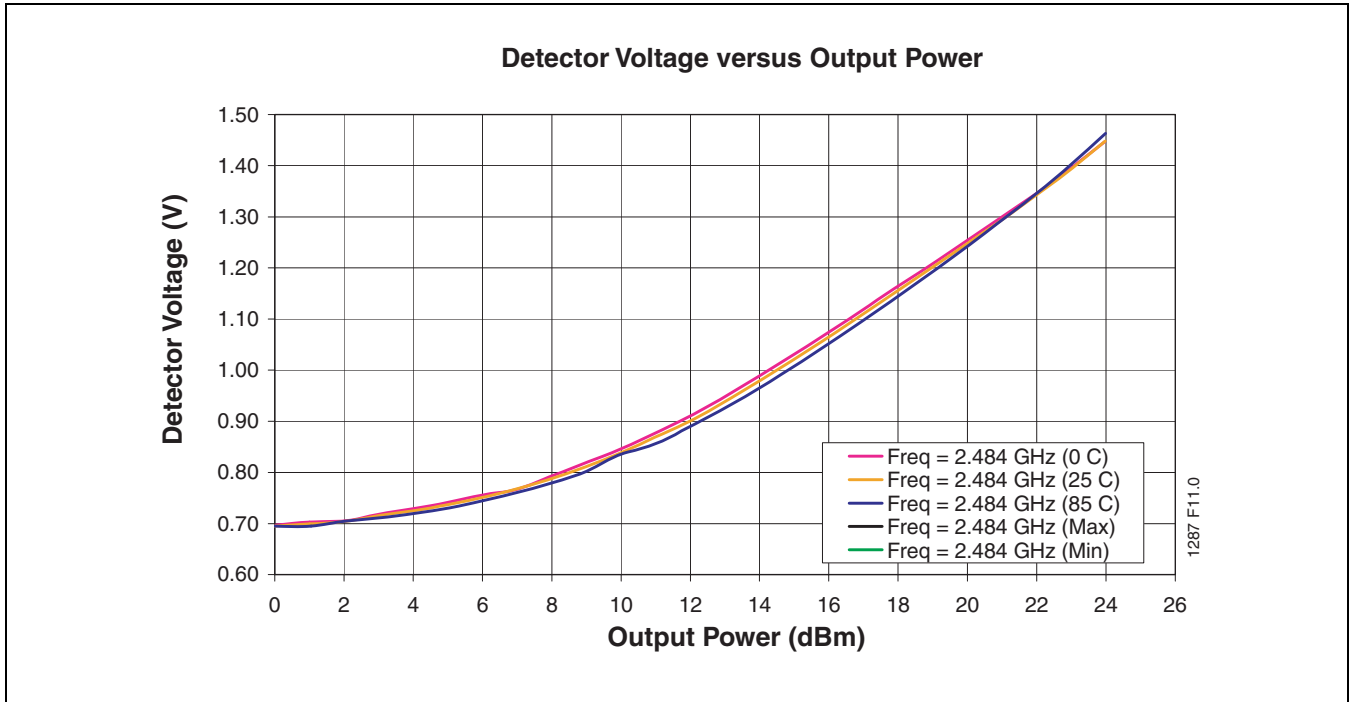

FIGURE 10: LOW BAND CH14 DETECTOR CHARACTERISTICS OVER TEMPERATURE WITH 2:1 OUTPUT VSWR ALL PHASES

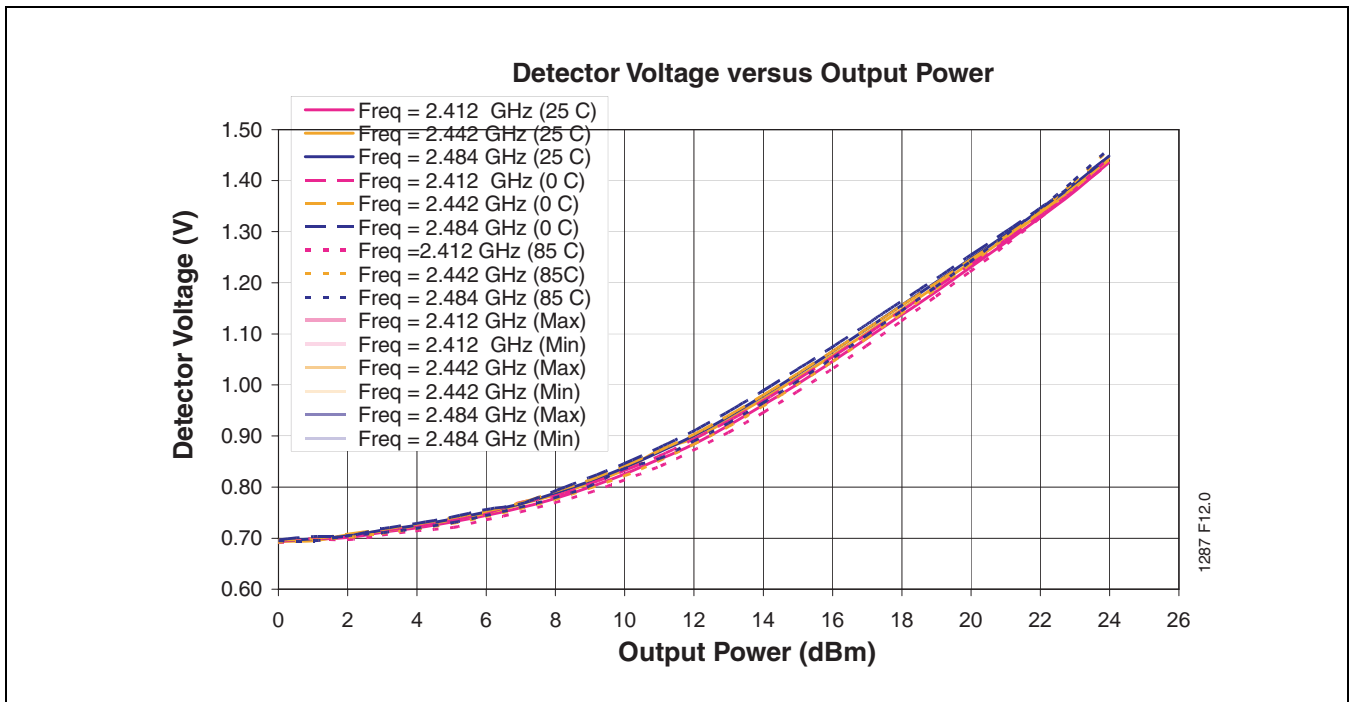

FIGURE 11: LOW BAND DETECTOR CHARACTERISTICS OVER TEMPERATURE WITH 2:1 OUTPUT VSWR ALL PHASES



Preliminary Specifications

LOW BAND POWER DETECTOR CHARACTERISTICS

TEST CONDITIONS: $V_{CC} = 3.3V$, $V_{REG_LB} = 2.85V$, $T_A = 25^\circ C$, 1 MPBS 802.11G CCK SIGNAL

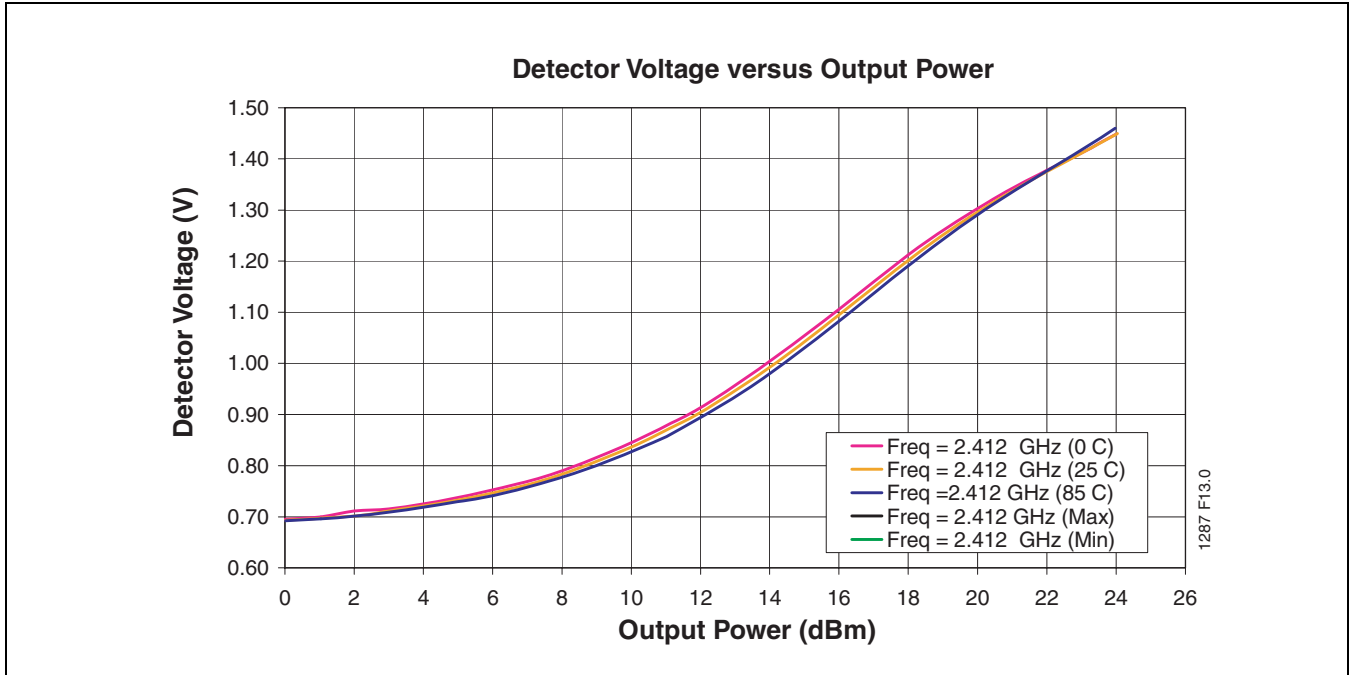

FIGURE 12: LOW BAND CH1 DETECTOR CHARACTERISTICS OVER TEMPERATURE WITH 2:1 OUTPUT VSWR ALL PHASES

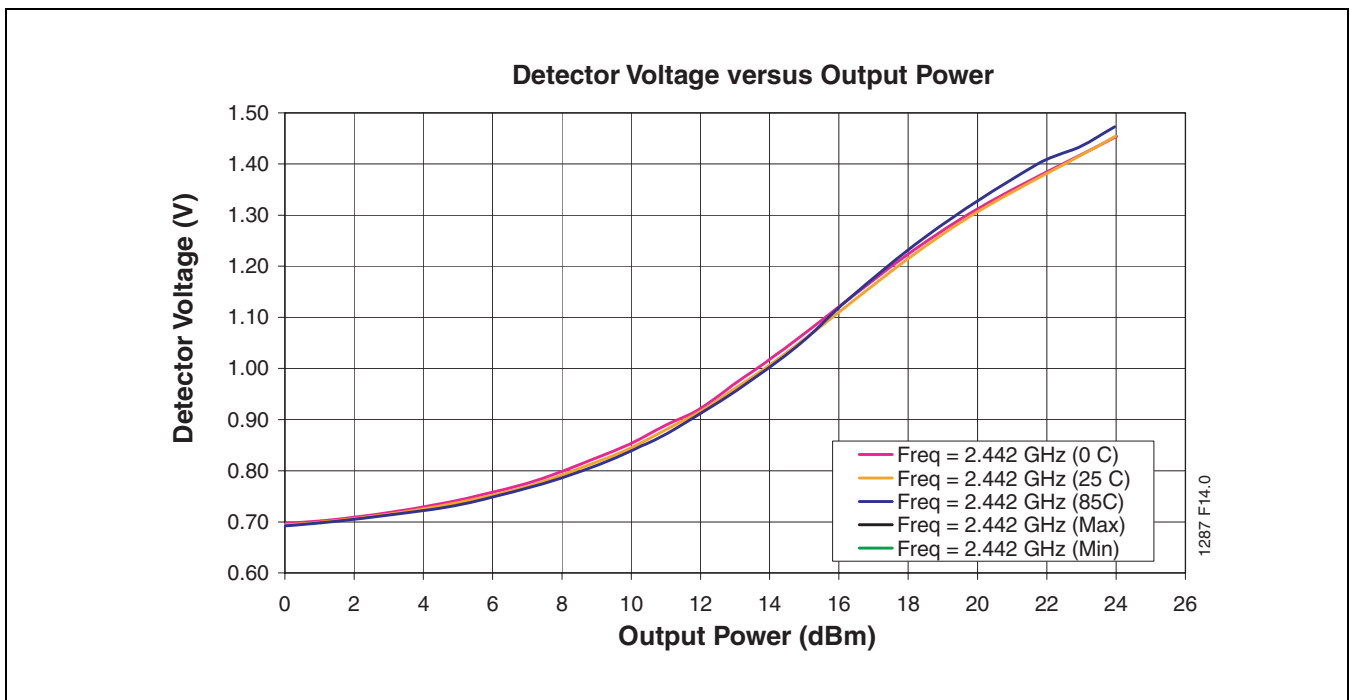

FIGURE 13: LOW BAND CH7 DETECTOR CHARACTERISTICS OVER TEMPERATURE WITH 2:1 OUTPUT VSWR ALL PHASES

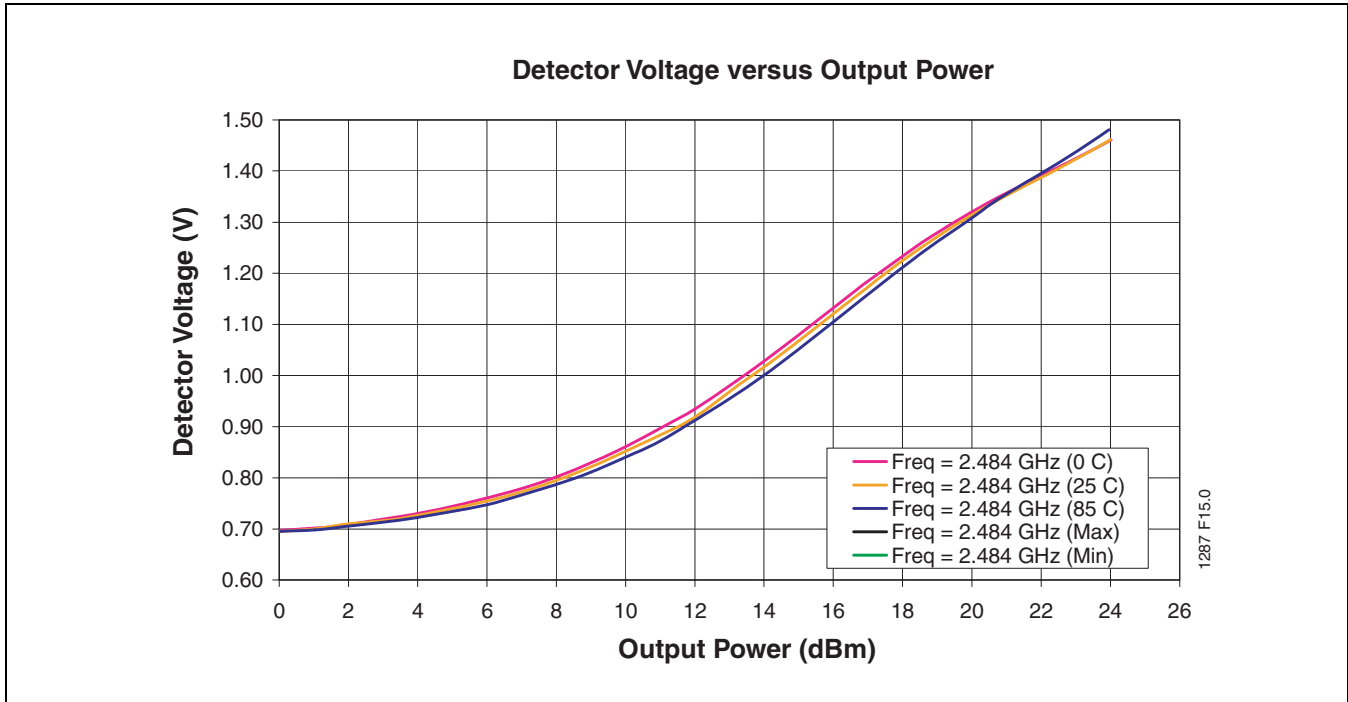

FIGURE 14: LOW BAND CH14 DETECTOR CHARACTERISTICS OVER TEMPERATURE WITH 2:1 OUTPUT VSWR ALL PHASES

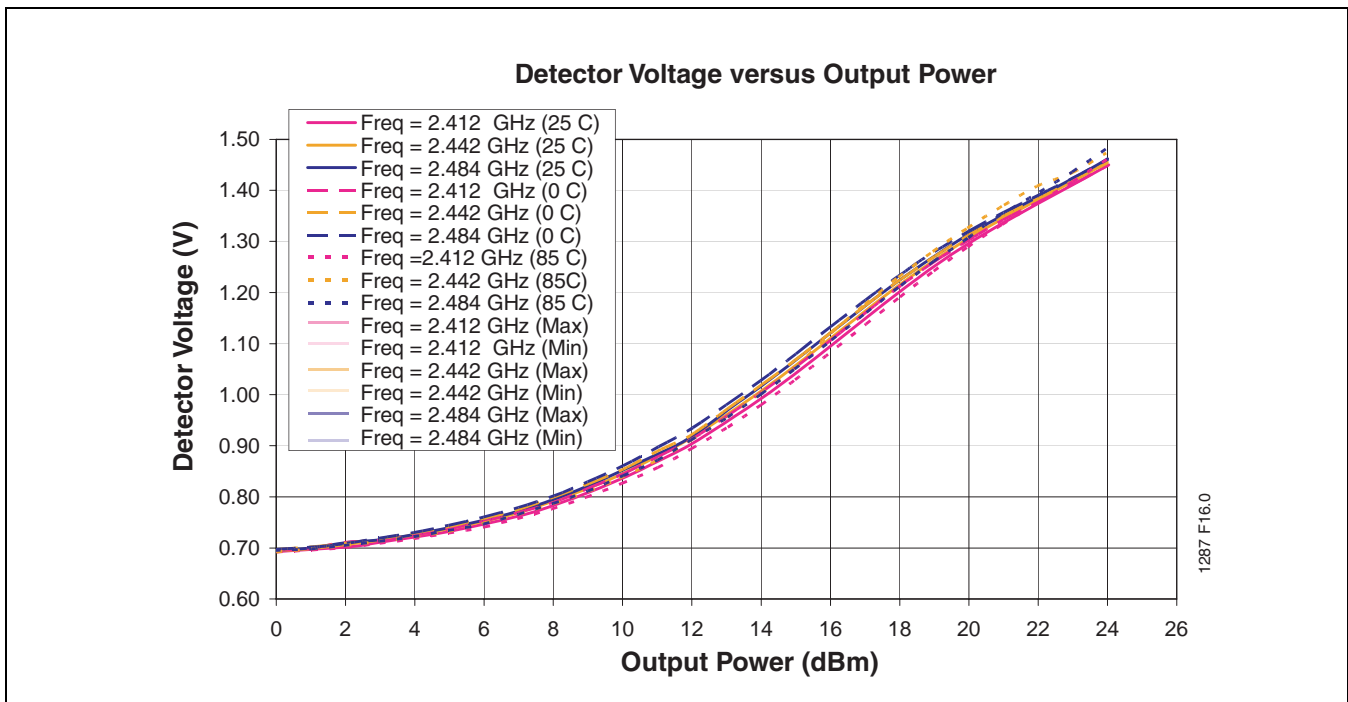

FIGURE 15: LOW BAND DETECTOR CHARACTERISTICS OVER TEMPERATURE WITH 2:1 OUTPUT VSWR ALL PHASES



2.4-2.5 GHz / 4.9-5.8 GHz Dual-Band Power Amplifier SST13LP01

Preliminary Specifications

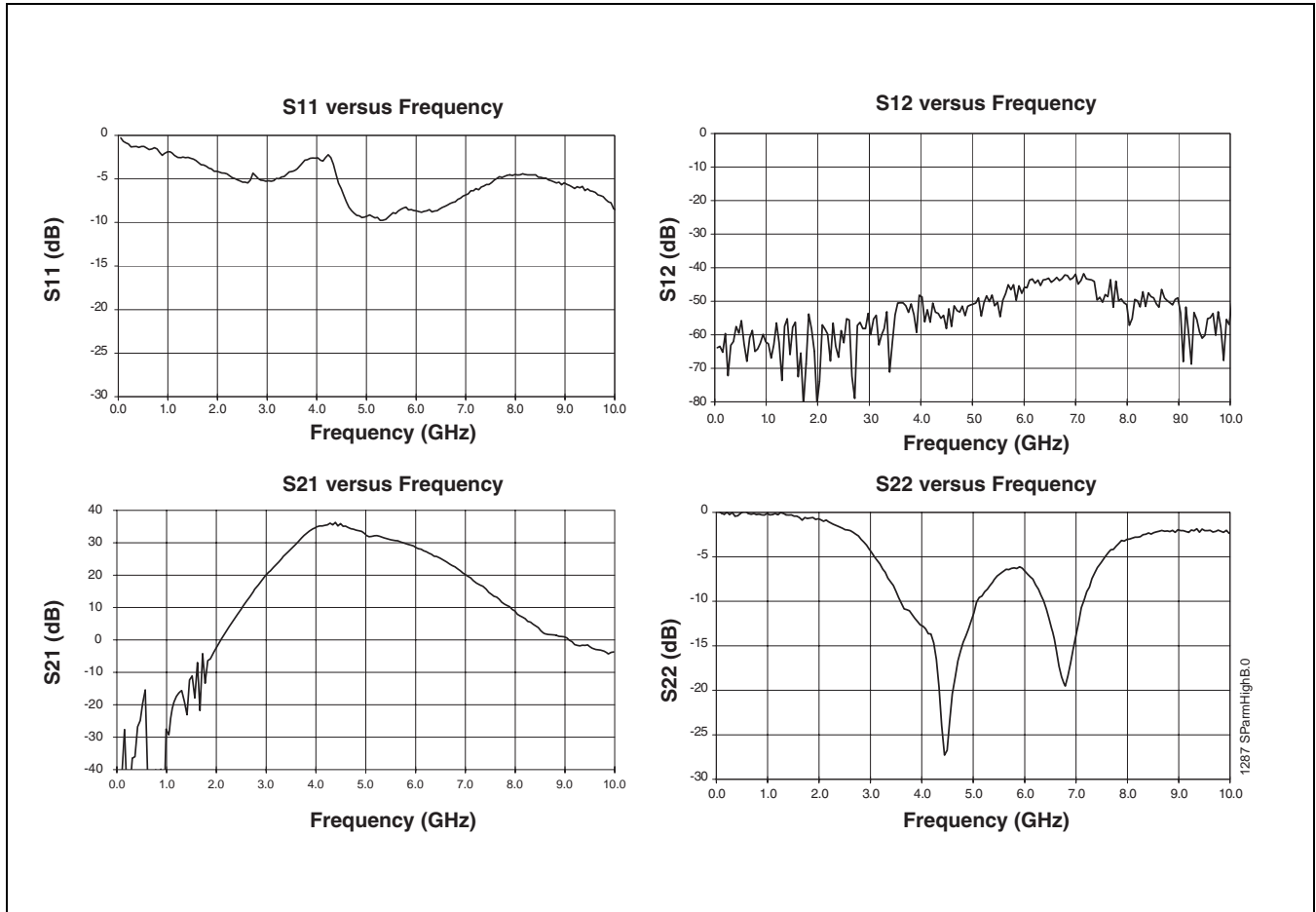

FIGURE 16: HIGH BAND S-PARAMETERS

TYPICAL PERFORMANCE CHARACTERISTICS FOR 802.11A

TEST CONDITIONS: $V_{CC} = 3.3V$, $V_{REG_HB} = 2.9V$, $T_A = 25^\circ C$, 54 MPBS 802.11A OFDM SIGNAL

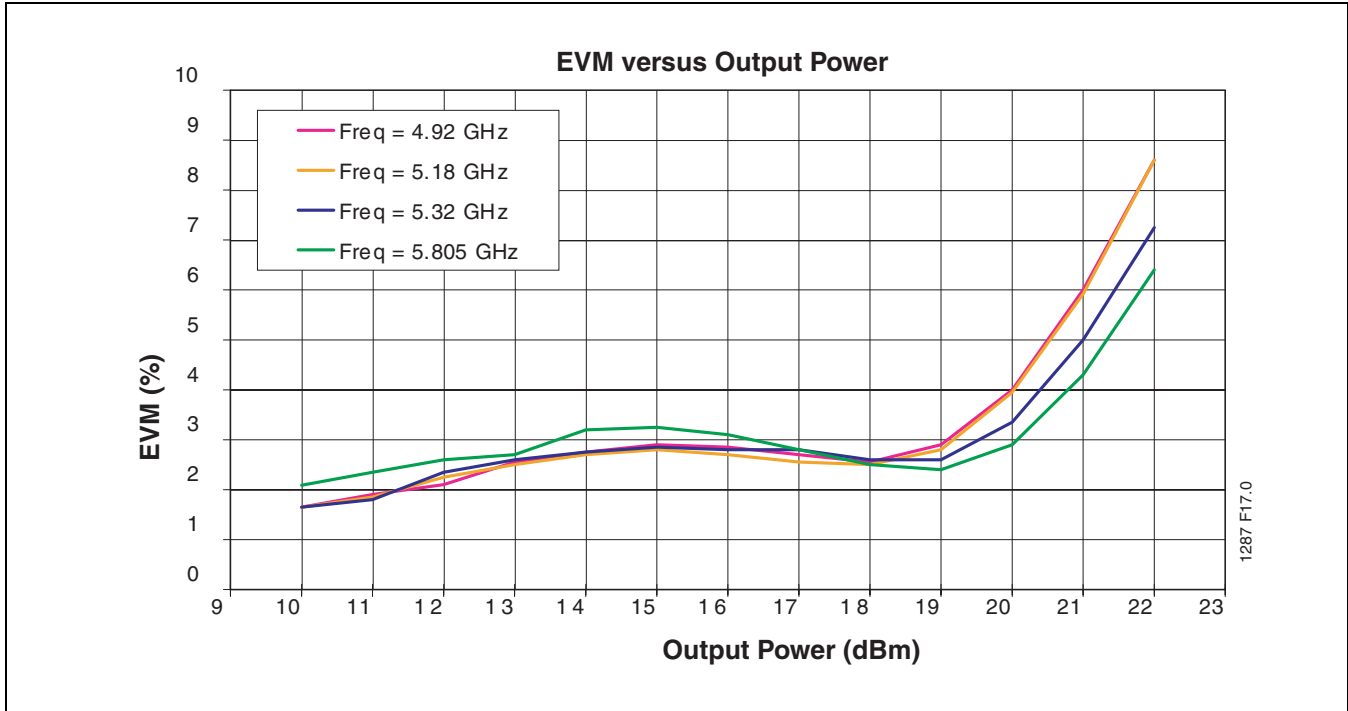

FIGURE 17: HIGH BAND EVM VERSUS OUTPUT POWER

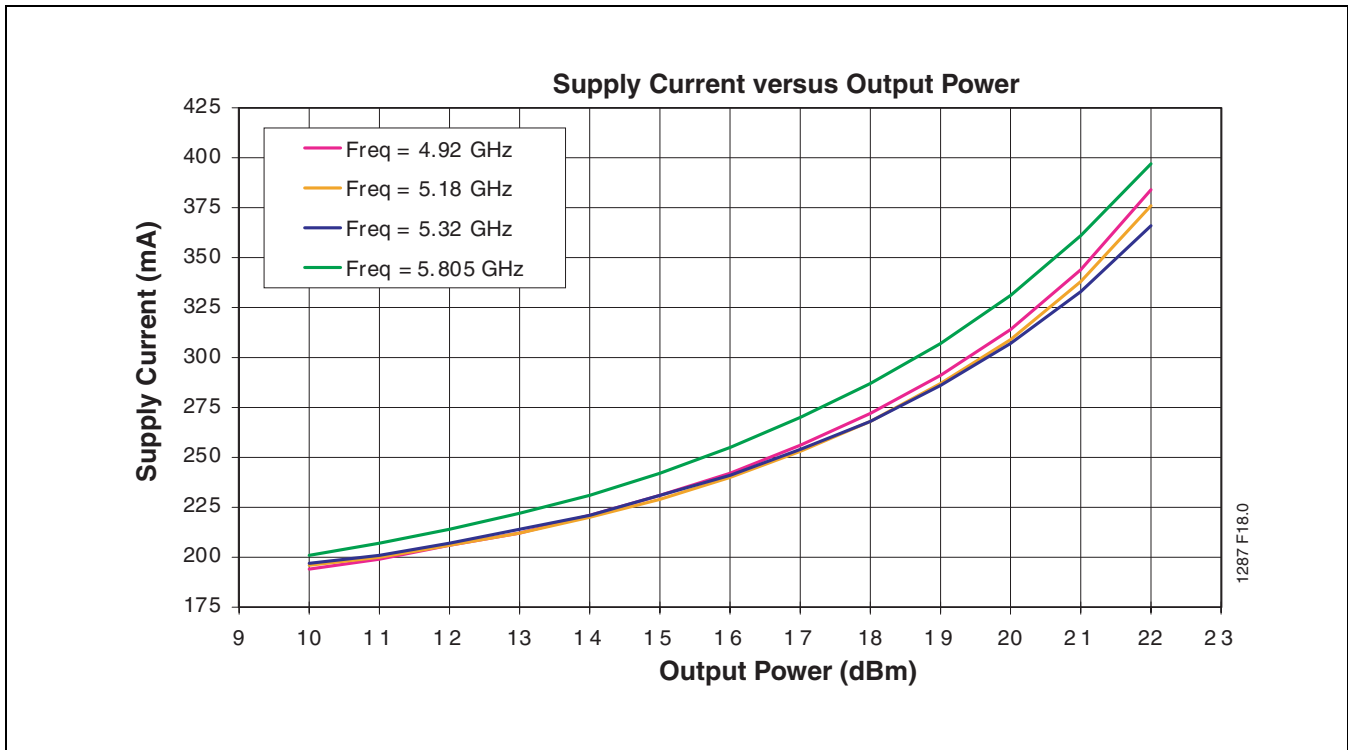

FIGURE 18: HIGH BAND POWER SUPPLY CURRENT VERSUS OUTPUT POWER



2.4-2.5 GHz / 4.9-5.8 GHz Dual-Band Power Amplifier SST13LP01

Preliminary Specifications

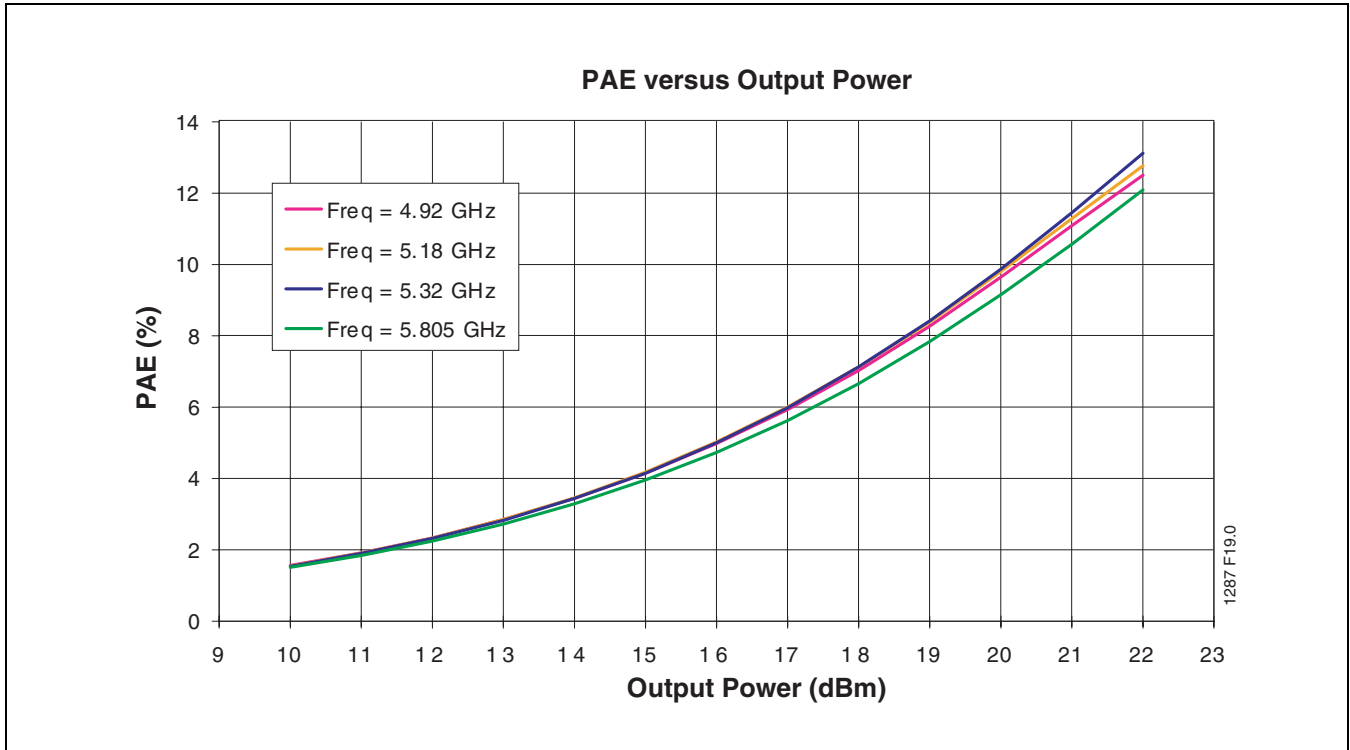

FIGURE 19: HIGH BAND PAE VERSUS OUTPUT POWER

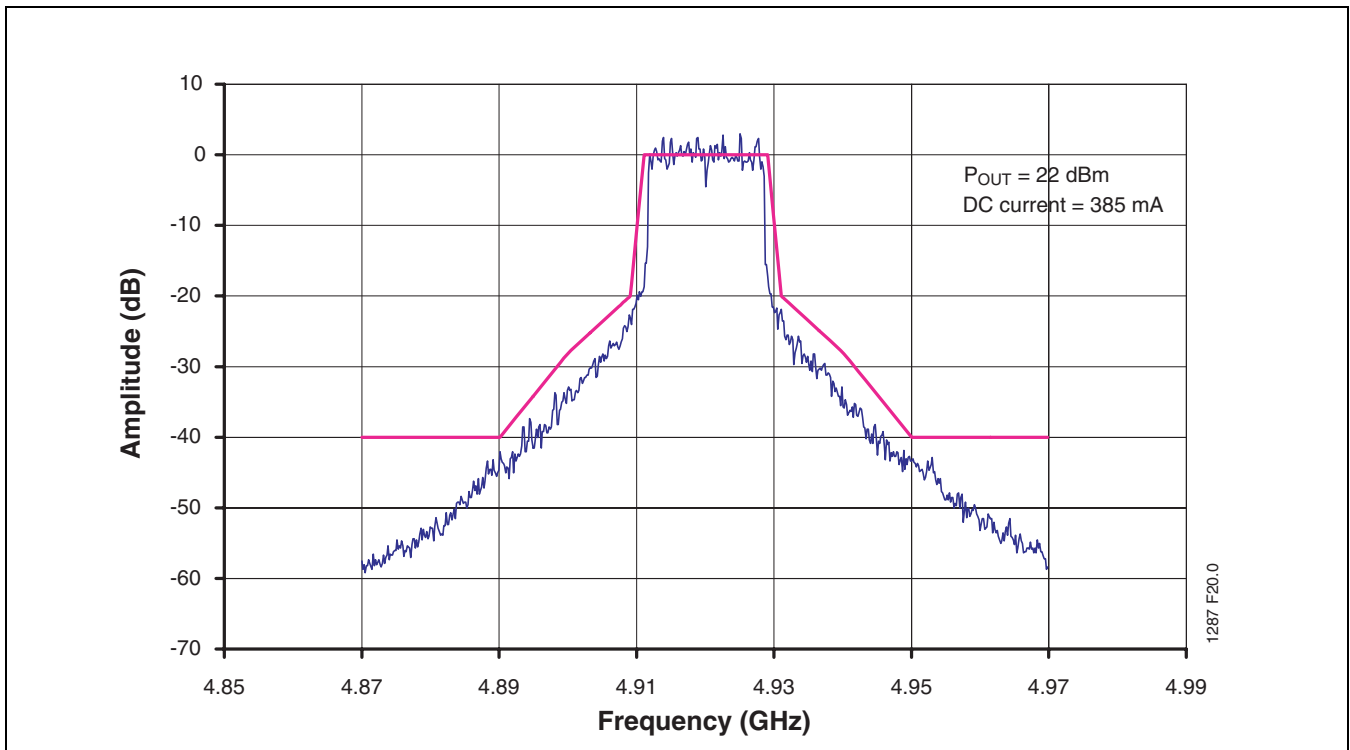

FIGURE 20: HIGH BAND 802.11A SPECTRUM MASK AT 4.92 GHz AT OUTPUT POWER 22 dBm WITH DC CURRENT AT 385 mA



2.4-2.5 GHz / 4.9-5.8 GHz Dual-Band Power Amplifier SST13LP01

Preliminary Specifications

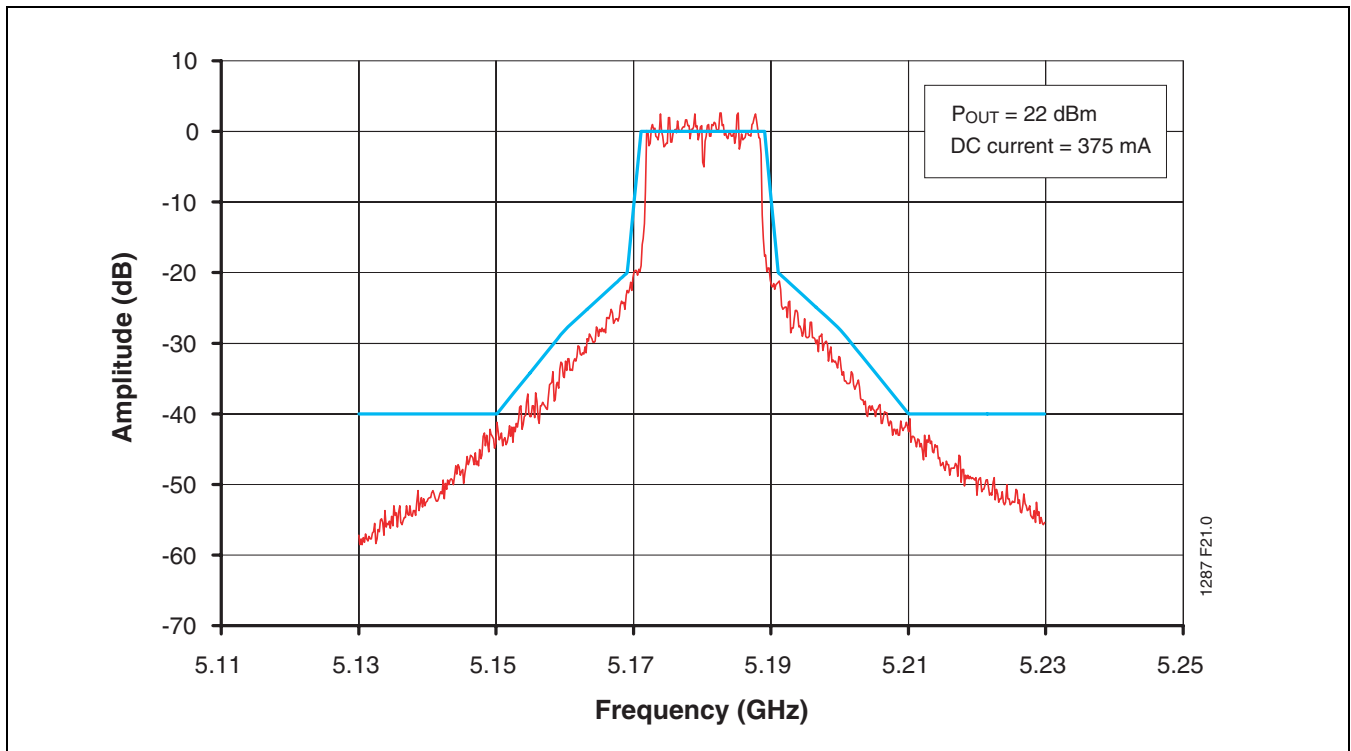

FIGURE 21: HIGH BAND 802.11A SPECTRUM MASK AT 5.18 GHz AT OUTPUT POWER 22 DBM WITH DC CURRENT AT 375 MA

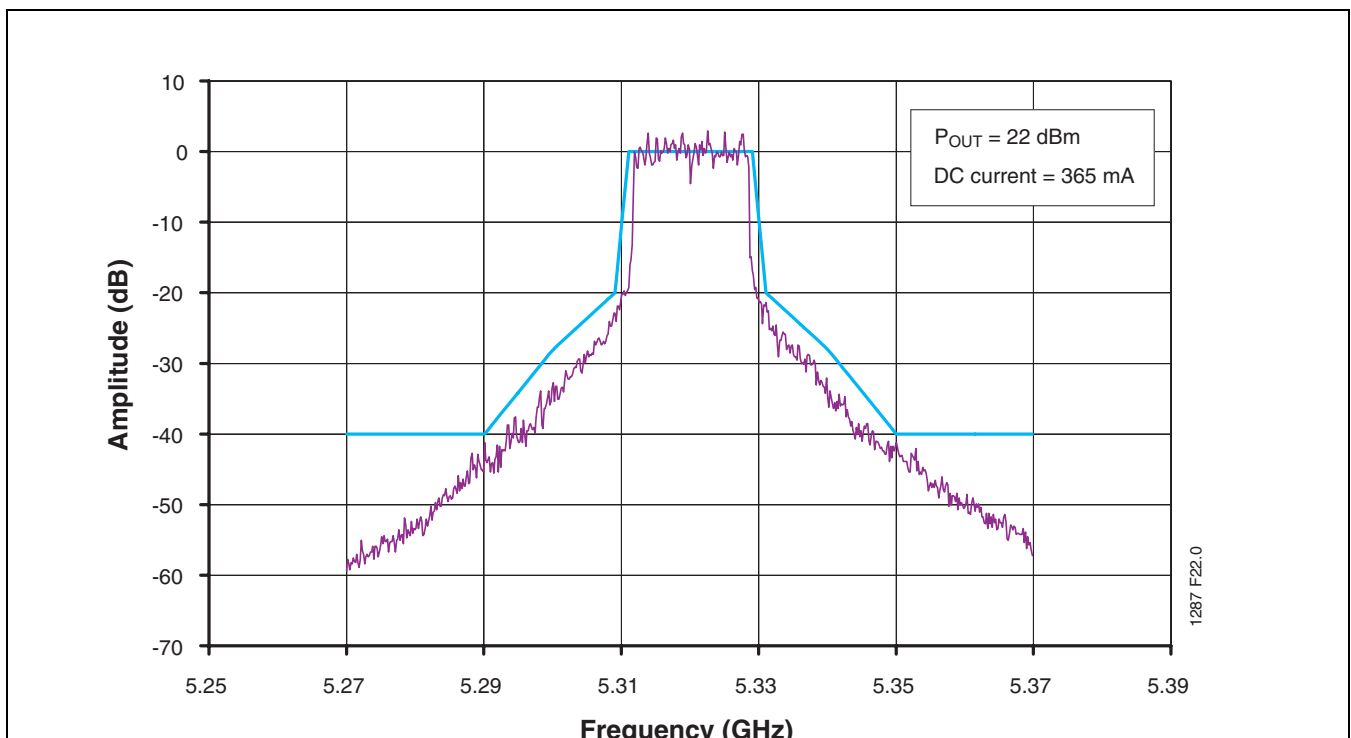

FIGURE 22: HIGH BAND 802.11A SPECTRUM MASK AT 5.32 GHz AT OUTPUT POWER 22 DBM WITH DC CURRENT AT 365 MA



2.4-2.5 GHz / 4.9-5.8 GHz Dual-Band Power Amplifier SST13LP01

Preliminary Specifications

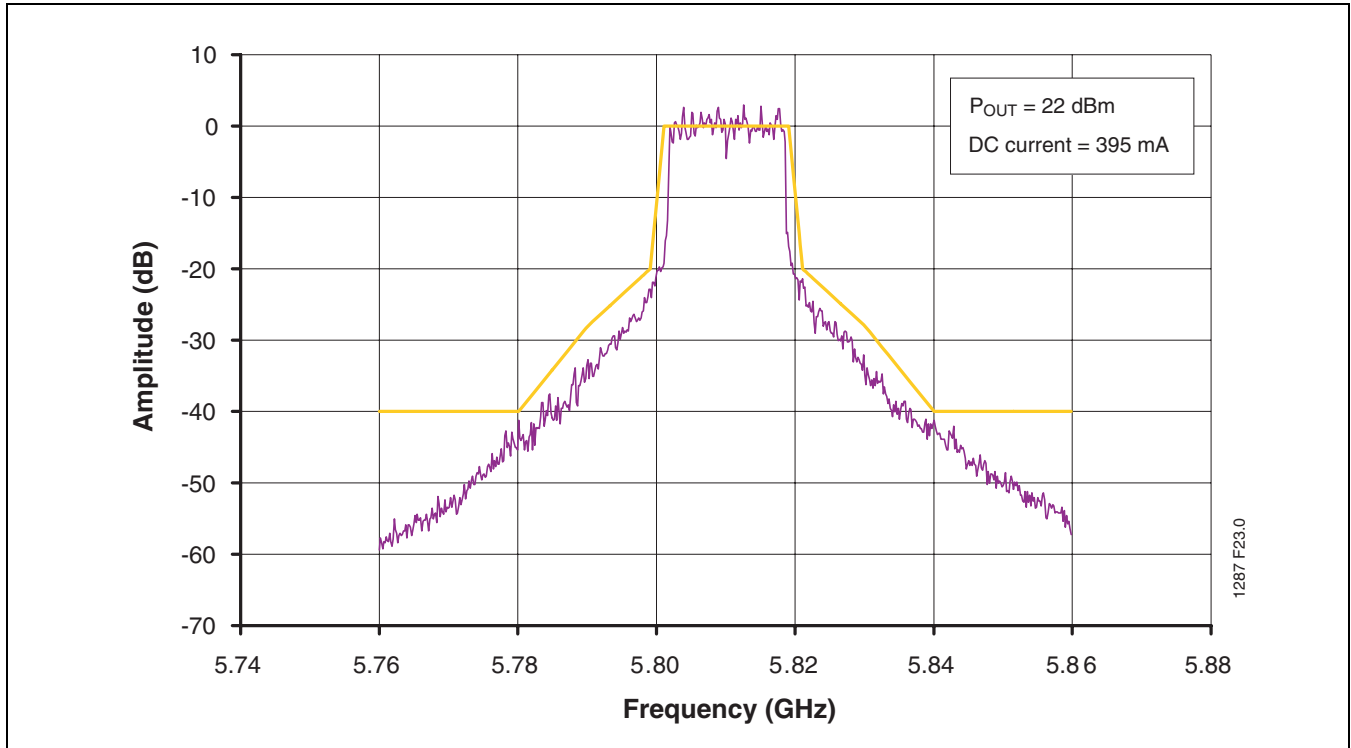

FIGURE 23: HIGH BAND 802.11A SPECTRUM MASK AT 5.805 GHz AT OUTPUT POWER 22 dBm WITH DC CURRENT AT 395 mA



HIGH BAND POWER DETECTOR CHARACTERISTICS

TEST CONDITIONS: $V_{CC} = 3.3V$, $V_{REG_HB} = 2.9V$, $T_A = 25^\circ C$, 54 MPBS 802.11A OFSM SIGNAL

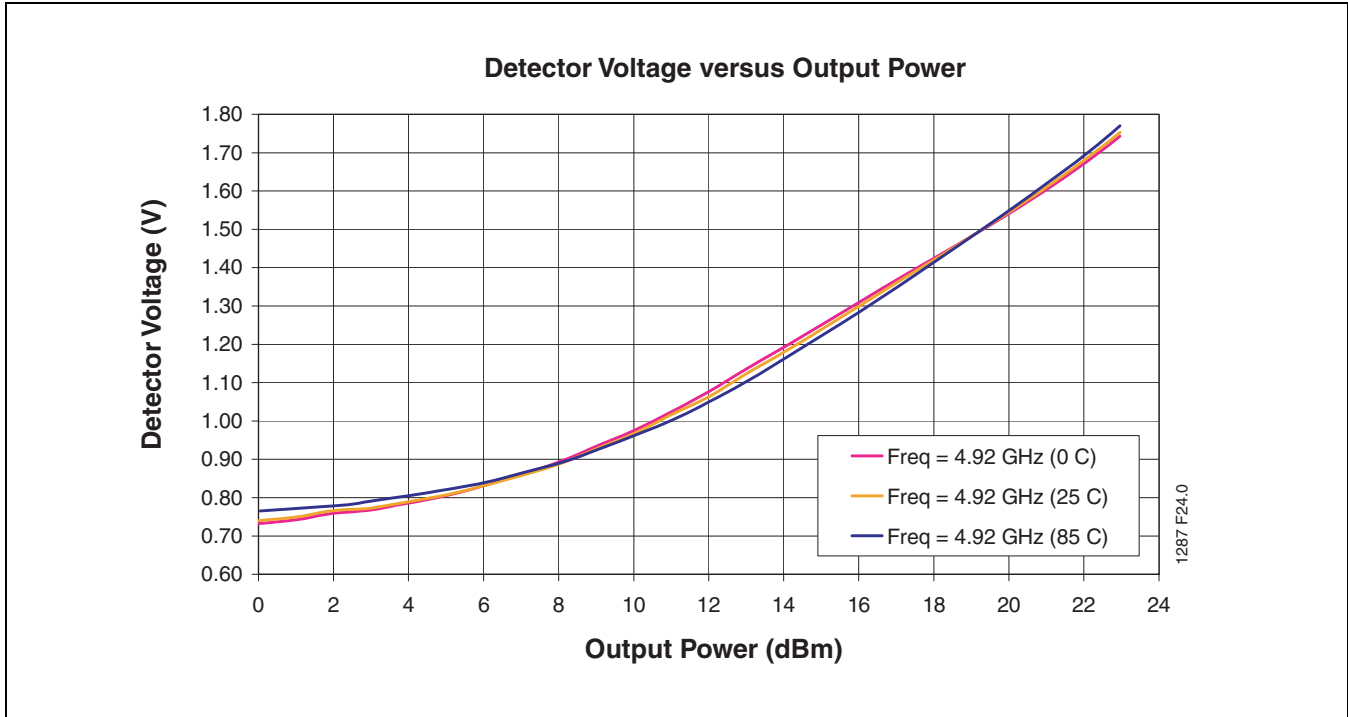

FIGURE 24: HIGH BAND DETECTOR CHARACTERISTICS OVER TEMPERATURE AT 4.92 GHz

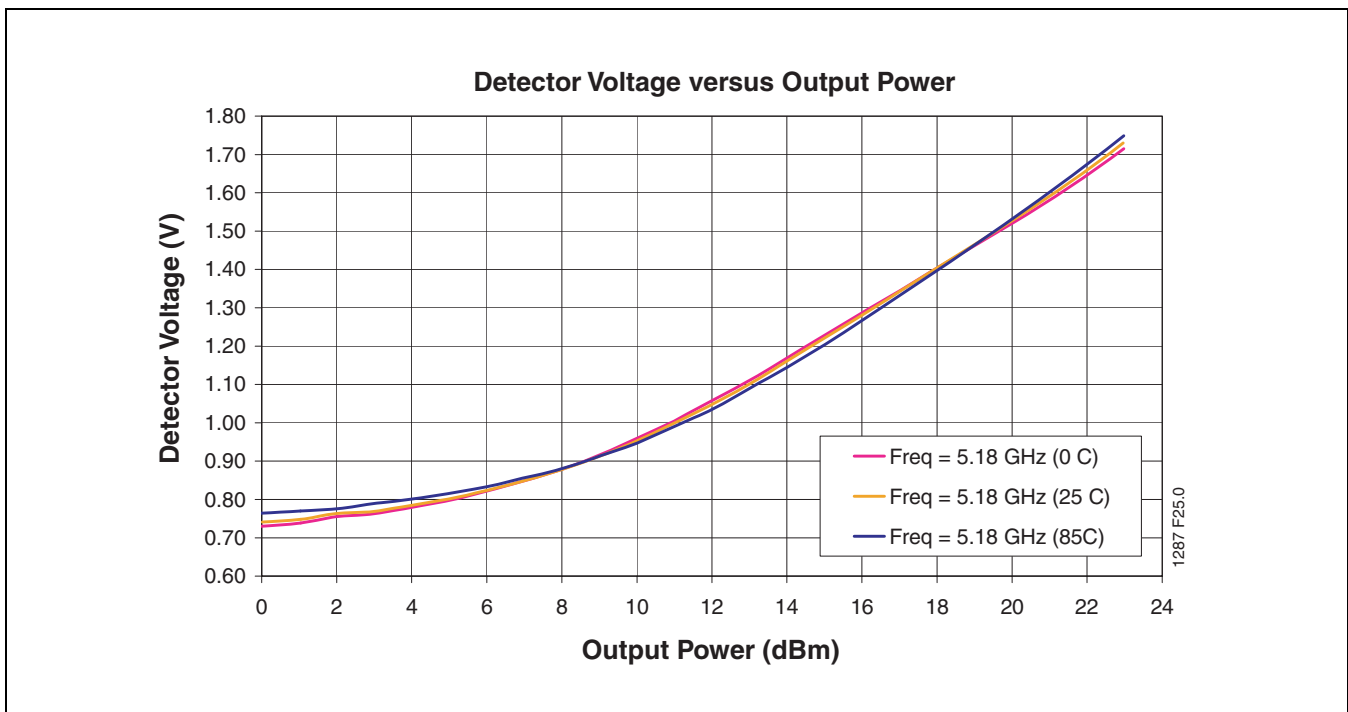

FIGURE 25: HIGH BAND DETECTOR CHARACTERISTICS OVER TEMPERATURE AT 5.18 GHz



Preliminary Specifications

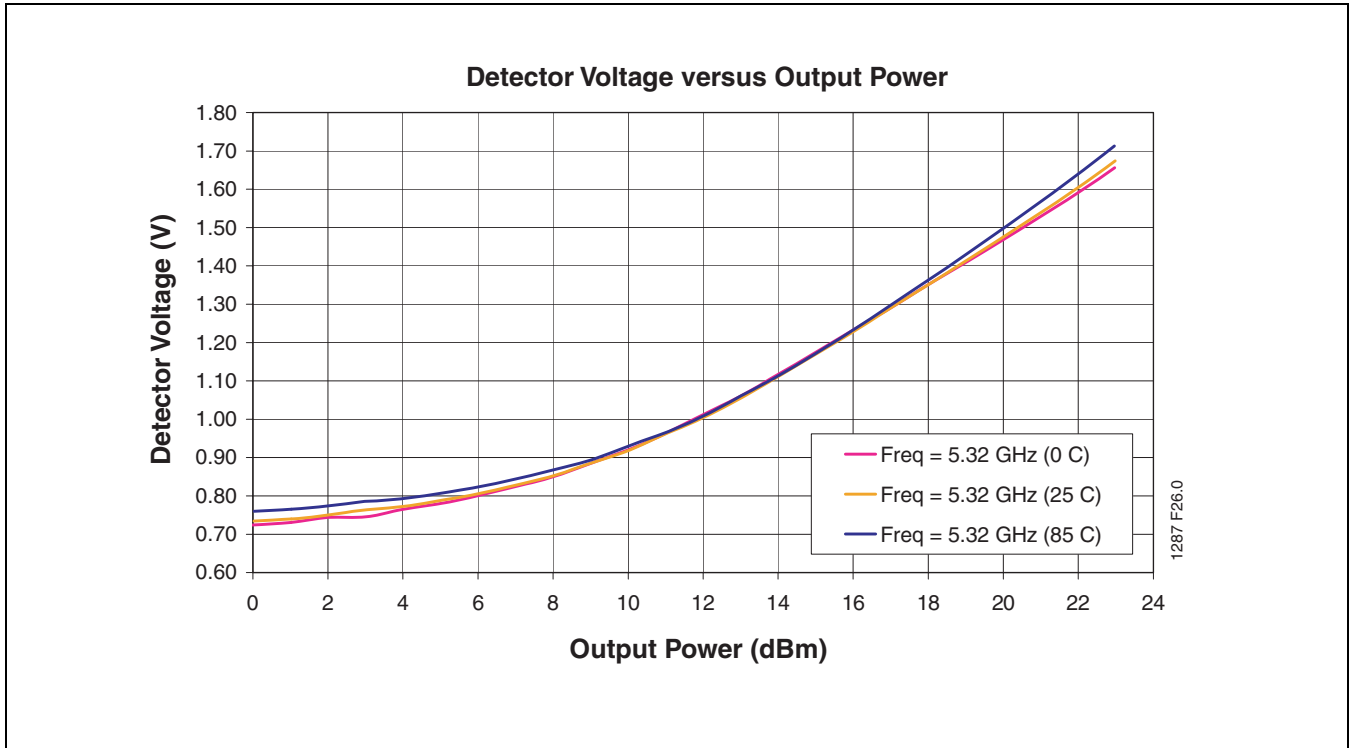

FIGURE 26: HIGH BAND DETECTOR CHARACTERISTICS OVER TEMPERATURE AT 5.32 GHz

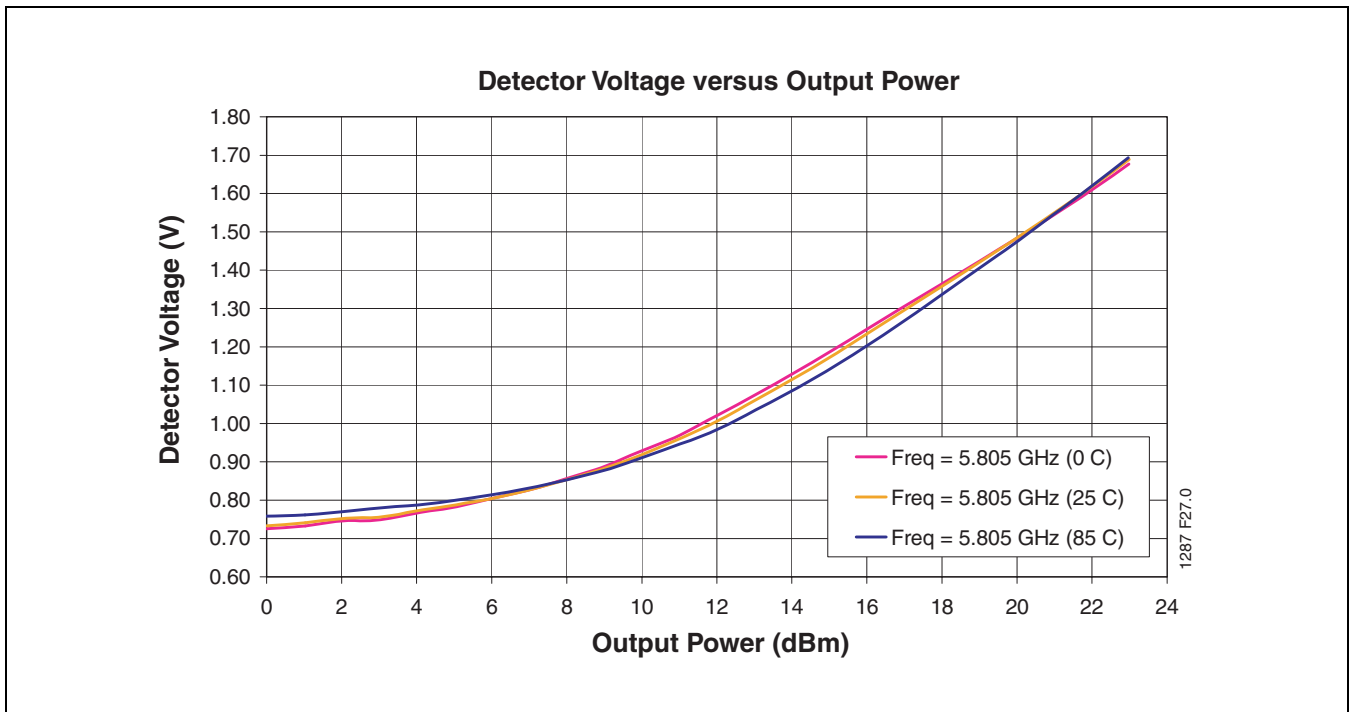

FIGURE 27: HIGH BAND DETECTOR CHARACTERISTICS OVER TEMPERATURE AT 5.805 GHz

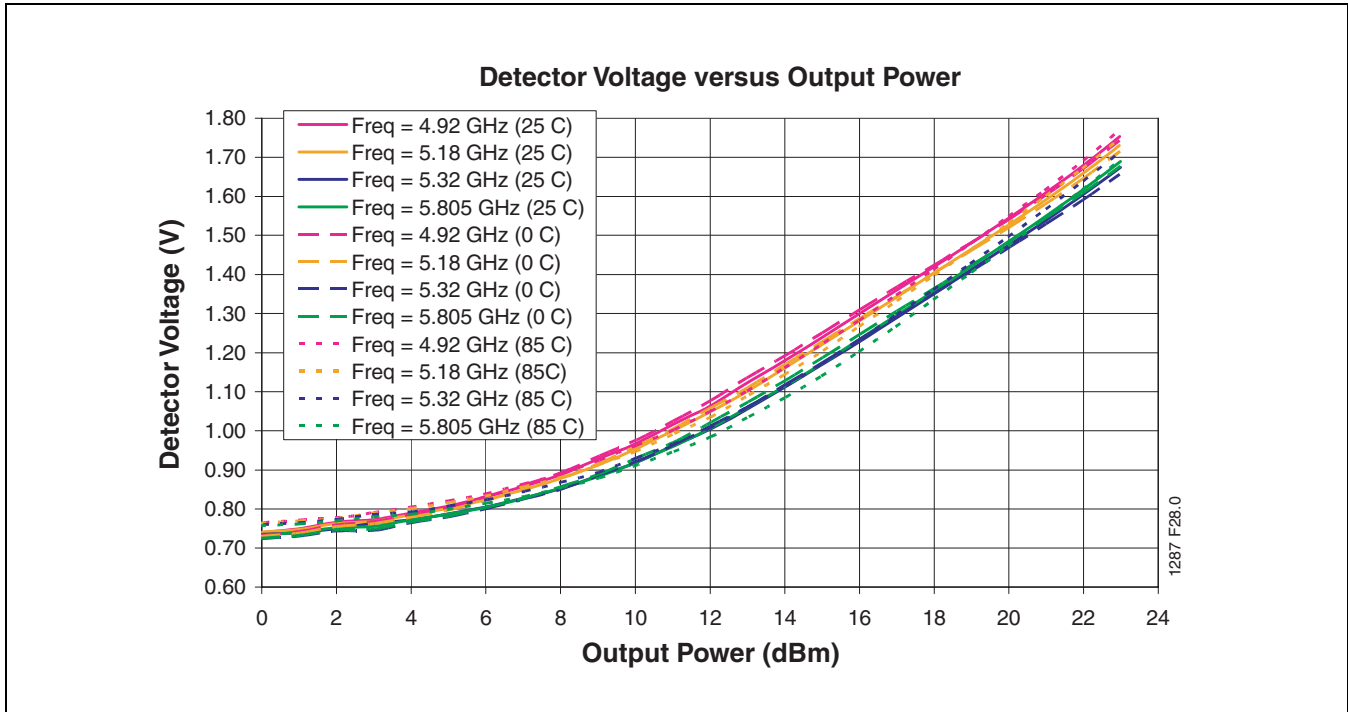

FIGURE 28: HIGH BAND DETECTOR CHARACTERISTICS OVER TEMPERATURE AND OVER FREQUENCY



2.4-2.5 GHz / 4.9-5.8 GHz Dual-Band Power Amplifier SST13LP01

Preliminary Specifications

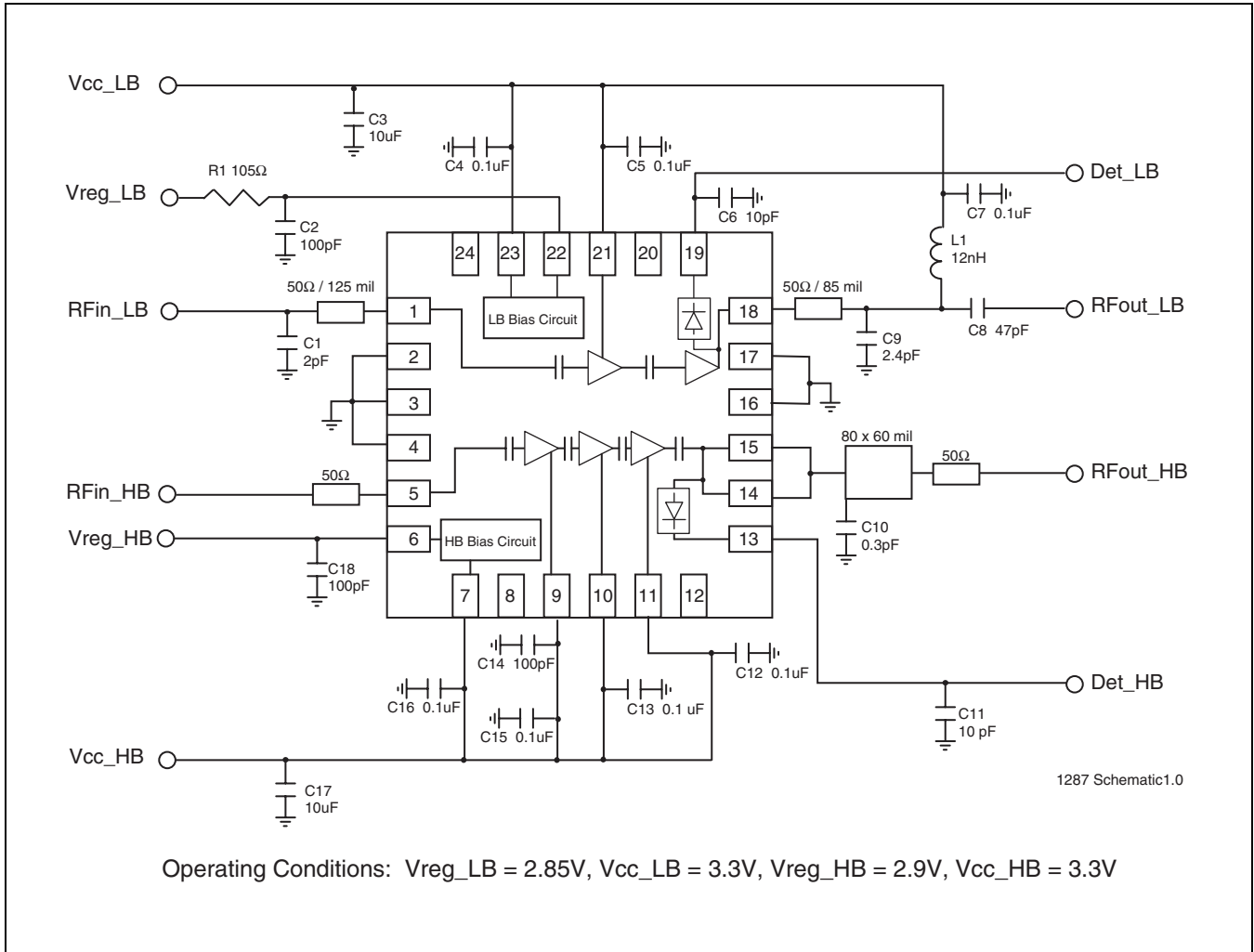

FIGURE 29: TYPICAL APPLICATION



2.4-2.5 GHz / 4.9-5.8 GHz Dual-Band Power Amplifier

SST13LP01

Preliminary Specifications

PRODUCT ORDERING INFORMATION

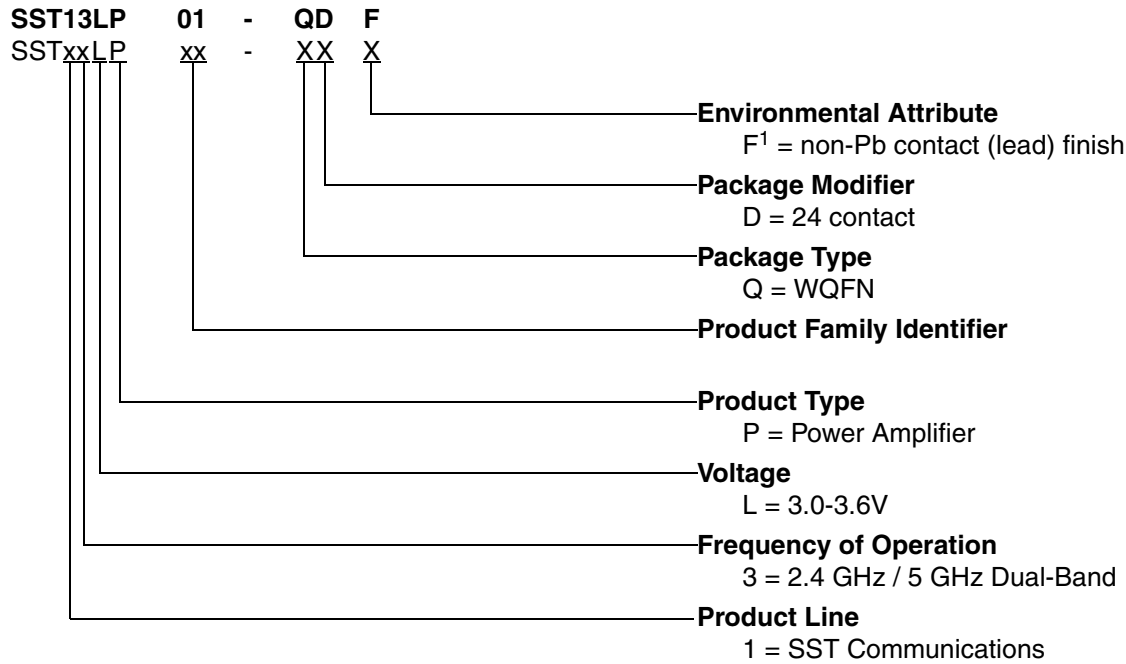

1. Environmental suffix "F" denotes non-Pb solder.
SST non-Pb solder devices are "RoHS Compliant".

Valid combinations for SST13LP01

SST13LP01-QDF

SST13LP01 Evaluation Kits

SST13LP01-QDF-K

Note: Valid combinations are those products in mass production or will be in mass production. Consult your SST sales representative to confirm availability of valid combinations and to determine availability of new combinations.



2.4-2.5 GHz / 4.9-5.8 GHz Dual-Band Power Amplifier SST13LP01

Preliminary Specifications

PACKAGING DIAGRAMS

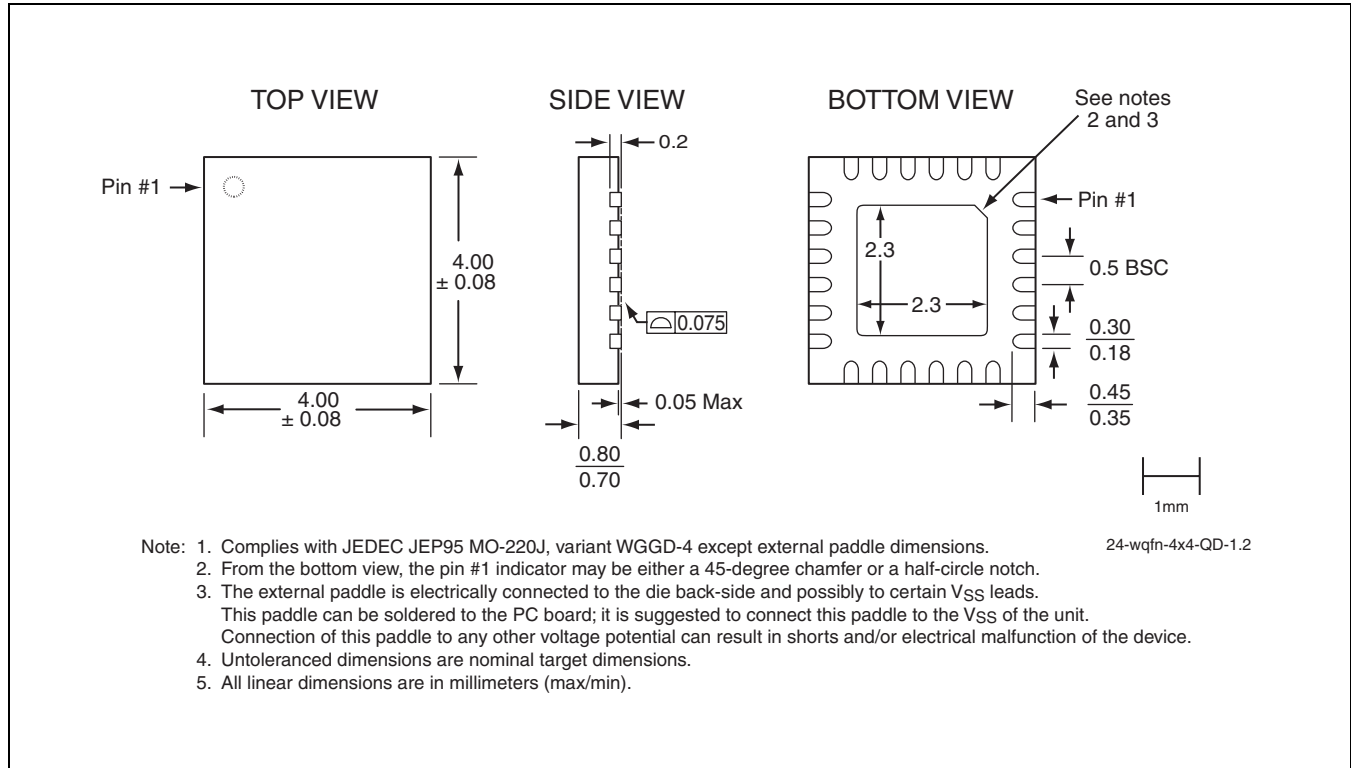

**24-CONTACT VERY-VERY-THIN-PROFILE QUAD FLAT NO-LEAD (WQFN)
SST PACKAGE CODE: QD**

TABLE 6: REVISION HISTORY

Revision	Description	Date
00	• SST conversion of data sheet GP1301	Nov 2005



2.4-2.5 GHz / 4.9-5.8 GHz Dual-Band Power Amplifier SST13LP01

Preliminary Specifications

CONTACT INFORMATION

Marketing

SST Communications Corp.

5340 Alla Road, Ste. 210
Los Angeles, CA 90066
Tel: 310-577-3600
Fax: 310-577-3605

Sales

NORTH AMERICA

Silicon Storage Technology, Inc.

Les Crowder
Technical Sales Support - North America
Tel: 949-495-6437
Fax: 949-495-6364
E-mail: lcrowder@sst.com

ASIA PACIFIC NORTH

SST Macao

H. H. Chang
Senior Director, Sales
Room N, 6th Floor,
Macao Finance Center, No. 202A-246,
Rua de Pequim, Macau
Tel: (853) 706-022
Fax: (853) 706-023
E-mail: hchang@sst.com

EUROPE

Silicon Storage Technology Ltd.

Ralph Thomson
Applications Manager
Mark House
9-11 Queens Road
Hersham KT12 5LU UK
Tel: +44 (0) 1869 321 431
Cell: +44 (0) 7787 508 919
E-mail: rthomson@sst.com

ASIA PACIFIC SOUTH

SST Communications Co.

Sunny Tzeng
Sales Manager
4F-2, No. 24, Lane 123, Sec.6,
Min Chuan E. Rd
Taipei 114, Taiwan, R.O.C.
Tel: +886-22795-6877 Ext. 163
Fax: +886-9792-1241
E-mail: stzeng@sst.com

JAPAN

SST Japan

Jun Kamata
Sales Director
9F Toshin-Tameike Bldg, 1-1-14 Akasaka,
Minato-ku, Tokyo, Japan 107-0052
Tel: (81) 3-5575-5515
Fax: (81) 3-5575-5516
Email: jkamata@sst.com

KOREA

SST Korea

Charlie Shin
Country Manager
Rm# 1101 DonGu Root Bldg, 16-2 Sunae-Dong,
Bundang-Gu, Sungnam, Kyunggi-Do
Korea, 463-020
Tel: (82) 31-715-9138
Fax: (82) 31-715-9137
Email: cshin@sst.com

Silicon Storage Technology, Inc. • 1171 Sonora Court • Sunnyvale, CA 94086 • Telephone 408-735-9110 • Fax 408-735-9036
www.SuperFlash.com or www.sst.com
