

1SMB5913BT3 Series

Preferred Device

3 Watt Plastic Surface Mount Zener Voltage Regulators

This complete new line of 3 Watt Zener diodes offers the following advantages.

Features

- Zener Voltage Range – 3.3 V to 200 V
- ESD Rating of Class 3 (>16 kV) per Human Body Model
- Flat Handling Surface for Accurate Placement
- Package Design for Top Side or Bottom Circuit Board Mounting
- Pb-Free Packages are Available

Mechanical Characteristics:

CASE: Void-free, transfer-molded plastic

FINISH: All external surfaces are corrosion resistant and leads are readily solderable

MAXIMUM LEAD TEMPERATURE FOR SOLDERING PURPOSES:
260°C for 10 Seconds

LEADS: Modified L-Bend providing more contact area to bond pads

POLARITY: Cathode indicated by polarity band

FLAMMABILITY RATING: UL 94 V-0

MAXIMUM RATINGS

Rating	Symbol	Value	Unit
Maximum Steady State Power Dissipation @ $T_L = 75^\circ\text{C}$ Measured at Zero Lead Length Derate Above 75°C	P_D	3.0	W
Thermal Resistance from Junction-to-Lead	$R_{\theta JL}$	40	$\text{mW}/^\circ\text{C}$
		25	$^\circ\text{C}/\text{W}$
Maximum Steady State Power Dissipation @ $T_A = 25^\circ\text{C}$ (Note) Derate Above 25°C	P_D	550	mW
Thermal Resistance from Junction-to-Ambient	$R_{\theta JA}$	4.4	$\text{mW}/^\circ\text{C}$
		226	$^\circ\text{C}/\text{W}$
Operating and Storage Temperature Range	T_J, T_{stg}	-65 to +150	$^\circ\text{C}$

Stresses exceeding Maximum Ratings may damage the device. Maximum Ratings are stress ratings only. Functional operation above the Recommended Operating Conditions is not implied. Extended exposure to stresses above the Recommended Operating Conditions may affect device reliability.

1. FR-4 board, using recommended footprint.



ON Semiconductor®

<http://onsemi.com>

PLASTIC SURFACE MOUNT ZENER VOLTAGE REGULATOR DIODES 3.3–200 V, 3 W DC POWER

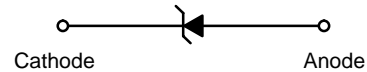

SMB
CASE 403A
PLASTIC

MARKING DIAGRAM



A = Assembly Location
Y = Year
WW = Work Week
9xxB = Device Code (Refer to page 3)
▪ = Pb-Free Package
(Note: Microdot may be in either location)

ORDERING INFORMATION

Device	Package	Shipping†
1SMB59xxBT3	SMB	2500/Tape & Reel
1SMB59xxBT3G	SMB (Pb-Free)	2500/Tape & Reel

†For information on tape and reel specifications, including part orientation and tape sizes, please refer to our Tape and Reel Packaging Specifications Brochure, BRD8011/D.

DEVICE MARKING INFORMATION

See specific marking information in the device marking column of the Electrical Characteristics table on page 3 of this data sheet.

Preferred devices are recommended choices for future use and best overall value.

1SMB5913BT3 Series

ELECTRICAL CHARACTERISTICS

($T_L = 30^\circ\text{C}$ unless otherwise noted,
 $V_F = 1.5\text{ V Max.}$ @ $I_F = 200\text{ mA(dc)}$ for all types)

Symbol	Parameter
V_Z	Reverse Zener Voltage @ I_{ZT}
I_{ZT}	Reverse Current
Z_{ZT}	Maximum Zener Impedance @ I_{ZT}
I_{ZK}	Reverse Current
Z_{ZK}	Maximum Zener Impedance @ I_{ZK}
I_R	Reverse Leakage Current @ V_R
V_R	Reverse Voltage
I_F	Forward Current
V_F	Forward Voltage @ I_F
I_{ZM}	Maximum DC Zener Current

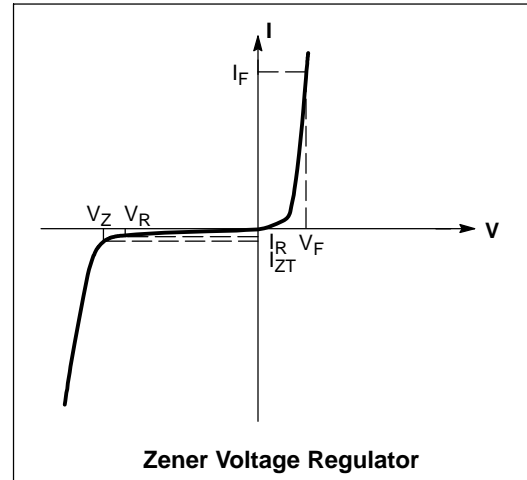

1SMB5913BT3 Series

ELECTRICAL CHARACTERISTICS (Devices listed in **bold, italic** are ON Semiconductor Preferred devices.)

($T_L = 30^\circ\text{C}$ unless otherwise noted, $V_F = 1.5\text{ V Max.}$ @ $I_F = 200\text{ mA(dc)}$ for all types)

Device* (Note 2)	Device Marking	Zener Voltage (Note 3)				Zener Impedance (Note 4)			Leakage Current		I_{ZM} mA(dc)
		V_Z (Volts)			@ I_{ZT}	Z_{ZT} @ I_{ZT}	Z_{ZK} @ I_{ZK}		I_R @ V_R		
		Min	Nom	Max	mA	Ω	Ω	mA	μA	Volts	
1SMB5913BT3, G	913B	3.13	3.3	3.47	113.6	10	500	1	100	1	454
1SMB5914BT3, G	914B	3.42	3.6	3.78	104.2	9	500	1	75	1	416
1SMB5915BT3, G	915B	3.70	3.9	4.10	96.1	7.5	500	1	25	1	384
1SMB5916BT3, G	916B	4.08	4.3	4.52	87.2	6	500	1	5	1	348
1SMB5917BT3, G	917B	4.46	4.7	4.94	79.8	5	500	1	5	1.5	319
1SMB5918BT3, G	918B	4.84	5.1	5.36	73.5	4	350	1	5	2	294
1SMB5919BT3, G	919B	5.32	5.6	5.88	66.9	2	250	1	5	3	267
1SMB5920BT3, G	920B	5.89	6.2	6.51	60.5	2	200	1	5	4	241
1SMB5921BT3, G	921B	6.46	6.8	7.14	55.1	2.5	200	1	5	5.2	220
1SMB5922BT3, G	922B	7.12	7.5	7.88	50	3	400	0.5	5	6	200
1SMB5923BT3, G	923B	7.79	8.2	8.61	45.7	3.5	400	0.5	5	6.5	182
1SMB5924BT3, G	924B	8.64	9.1	9.56	41.2	4	500	0.5	5	7	164
1SMB5925BT3, G	925B	9.5	10	10.5	37.5	4.5	500	0.25	5	8	150
1SMB5926BT3, G	926B	10.45	11	11.55	34.1	5.5	550	0.25	1	8.4	136
1SMB5927BT3, G	927B	11.4	12	12.6	31.2	6.5	550	0.25	1	9.1	125
1SMB5928BT3, G	928B	12.35	13	13.65	28.8	7	550	0.25	1	9.9	115
1SMB5929BT3, G	929B	14.25	15	15.75	25	9	600	0.25	1	11.4	100
1SMB5930BT3, G	930B	15.2	16	16.8	23.4	10	600	0.25	1	12.2	93
1SMB5931BT3, G	931B	17.1	18	18.9	20.8	12	650	0.25	1	13.7	83
1SMB5932BT3, G	932B	19	20	21	18.7	14	650	0.25	1	15.2	75
1SMB5933BT3, G	933B	20.9	22	23.1	17	17.5	650	0.25	1	16.7	68
1SMB5934BT3, G	934B	22.8	24	25.2	15.6	19	700	0.25	1	18.2	62
1SMB5935BT3, G	935B	25.65	27	28.35	13.9	23	700	0.25	1	20.6	55
1SMB5936BT3, G	936B	28.5	30	31.5	12.5	28	750	0.25	1	22.8	50
1SMB5937BT3, G	937B	31.35	33	34.65	11.4	33	800	0.25	1	25.1	45
1SMB5938BT3, G	938B	34.2	36	37.8	10.4	38	850	0.25	1	27.4	41
1SMB5939BT3, G	939B	37.05	39	40.95	9.6	45	900	0.25	1	29.7	38
1SMB5940BT3, G	940B	40.85	43	45.15	8.7	53	950	0.25	1	32.7	34
1SMB5941BT3, G	941B	44.65	47	49.35	8	67	1000	0.25	1	35.8	31
1SMB5942BT3, G	942B	48.45	51	53.55	7.3	70	1100	0.25	1	38.8	29
1SMB5943BT3, G	943B	53.2	56	58.8	6.7	86	1300	0.25	1	42.6	26
1SMB5944BT3, G	944B	58.9	62	65.1	6	100	1500	0.25	1	47.1	24
1SMB5945BT3, G	945B	64.6	68	71.4	5.5	120	1700	0.25	1	51.7	22
1SMB5946BT3, G	946B	71.25	75	78.75	5	140	2000	0.25	1	56	20
1SMB5947BT3, G	947B	77.9	82	86.1	4.6	160	2500	0.25	1	62.2	18
1SMB5948BT3, G	948B	86.45	91	95.55	4.1	200	3000	0.25	1	69.2	16
1SMB5949BT3, G	949B	95	100	105	3.7	250	3100	0.25	1	76	15
1SMB5950BT3, G	950B	104.5	110	115.5	3.4	300	4000	0.25	1	83.6	13
1SMB5951BT3, G	951B	114	120	126	3.1	380	4500	0.25	1	91.2	12
1SMB5952BT3, G	952B	123.5	130	136.5	2.9	450	5000	0.25	1	98.8	11
1SMB5953BT3, G	953B	142.5	150	157.5	2.5	600	6000	0.25	1	114	10
1SMB5954BT3, G	954B	152	160	168	2.3	700	6500	0.25	1	121.6	9
1SMB5955BT3, G	955B	171	180	189	2.1	900	7000	0.25	1	136.8	8
1SMB5956BT3, G	956B	190	200	210	1.9	1200	8000	0.25	1	152	7

2. **TOLERANCE AND TYPE NUMBER DESIGNATION** The type numbers listed indicate a tolerance of $\pm 5\%$.

3. **ZENER VOLTAGE (V_Z) MEASUREMENT**

Nominal Zener voltage is measured with the device junction in thermal equilibrium with ambient temperature at 25°C .

4. **ZENER IMPEDANCE (Z_Z) DERIVATION** Z_{ZT} and Z_{ZK} are measured by dividing the ac voltage drop across the device by the ac current applied. The specified limits are for $I_{Z(ac)} = 0.1 I_{Z(dc)}$ with the ac frequency = 60 Hz.

* The "G" suffix indicates Pb-Free package available.

1SMB5913BT3 Series

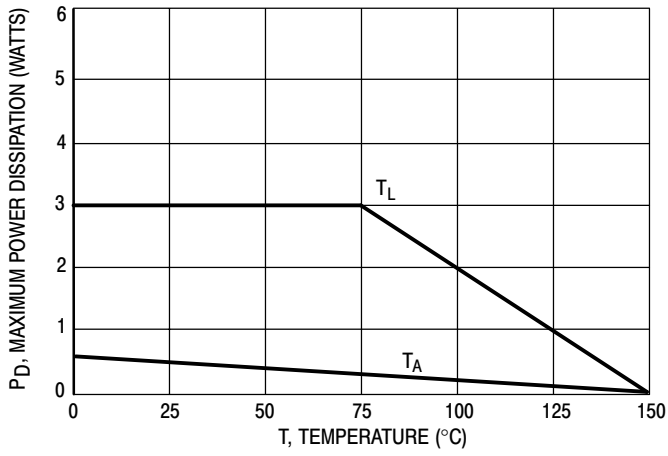

Figure 1. Steady State Power Derating

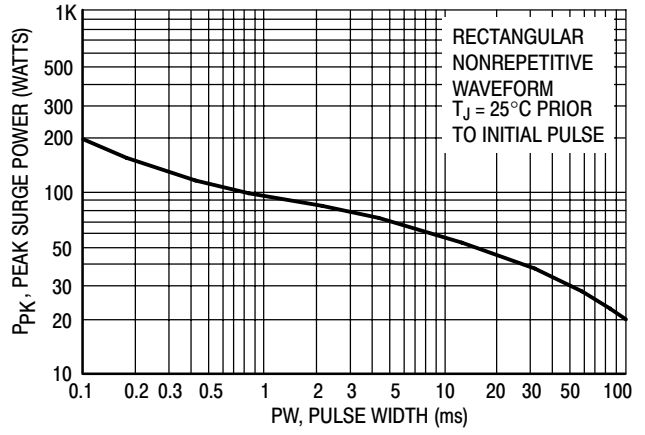

Figure 2. Maximum Surge Power

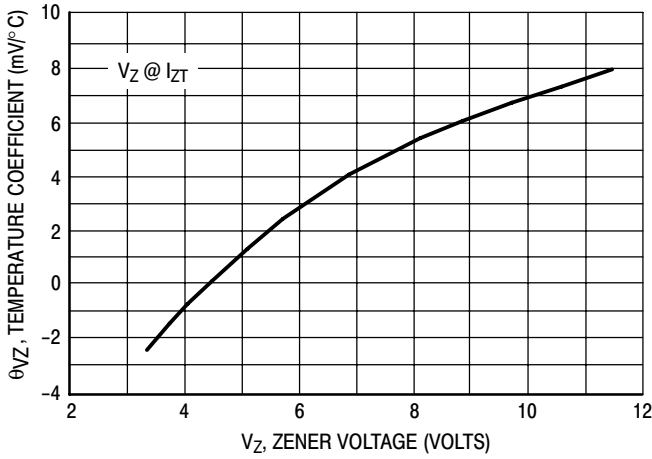

Figure 3. Zener Voltage - To 12 Volts

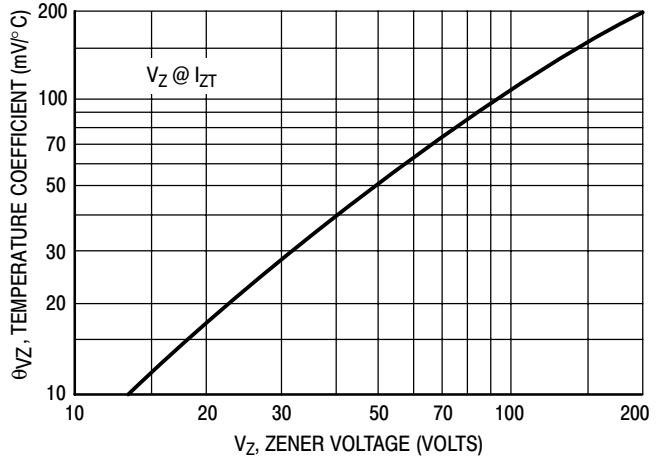

Figure 4. Zener Voltage - 14 To 200 Volts

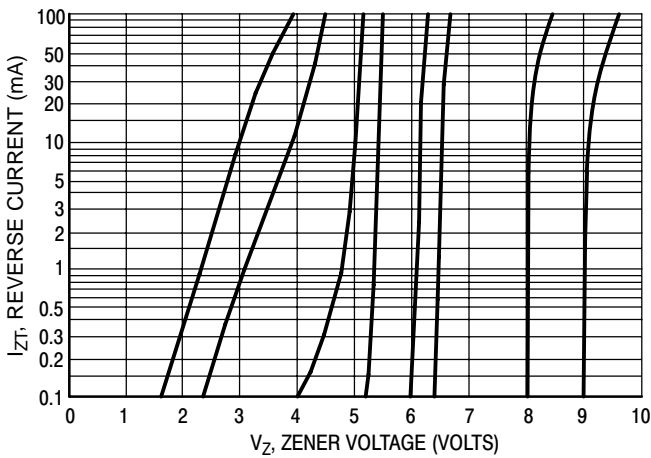

Figure 5. $V_Z = 3.3$ thru 10 Volts

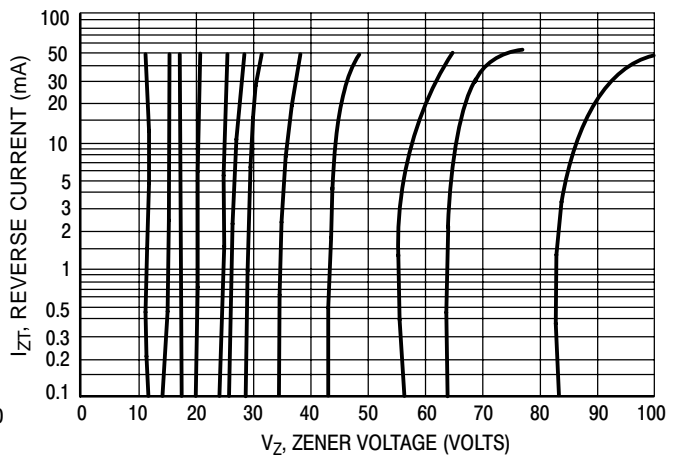

Figure 6. $V_Z = 12$ thru 82 Volts

1SMB5913BT3 Series

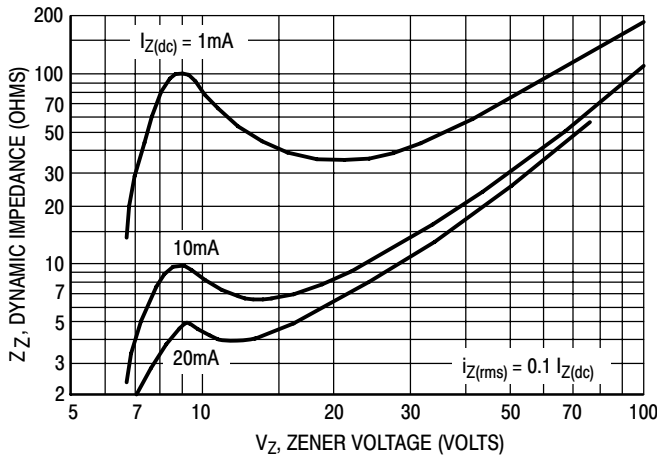

Figure 7. Effect of Zener Voltage

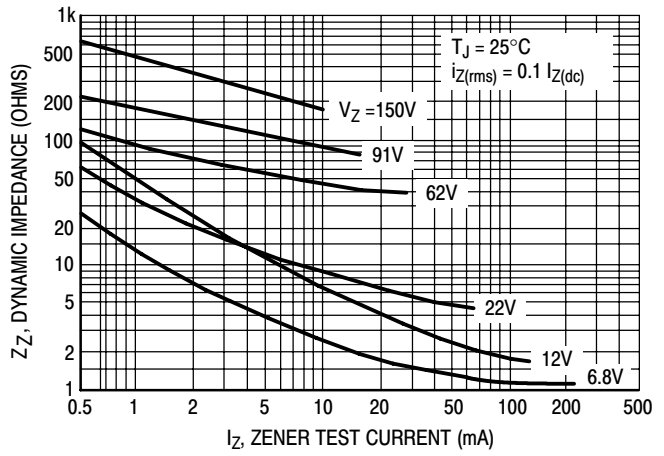

Figure 8. Effect of Zener Current

Rating and Typical Characteristic Curves ($T_A = 25^\circ\text{C}$)

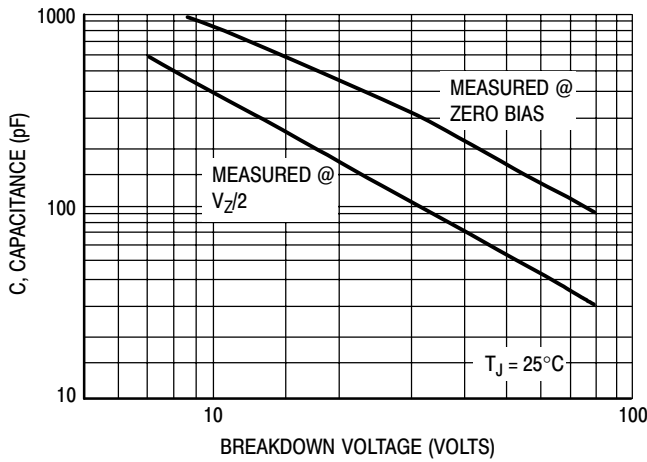

Figure 9. Capacitance Curve

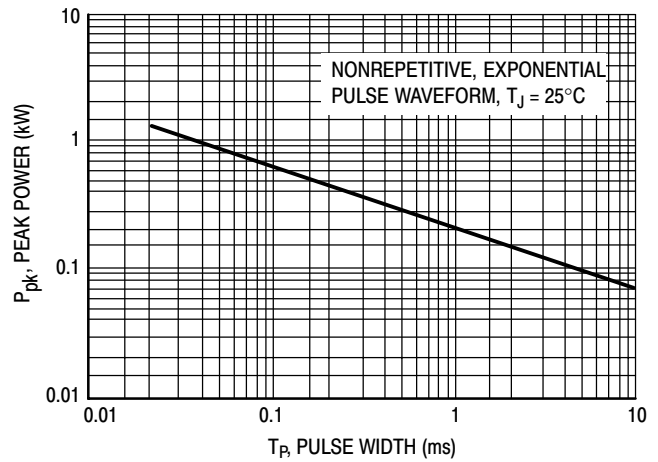

Figure 10. Typical Pulse Rating Curve

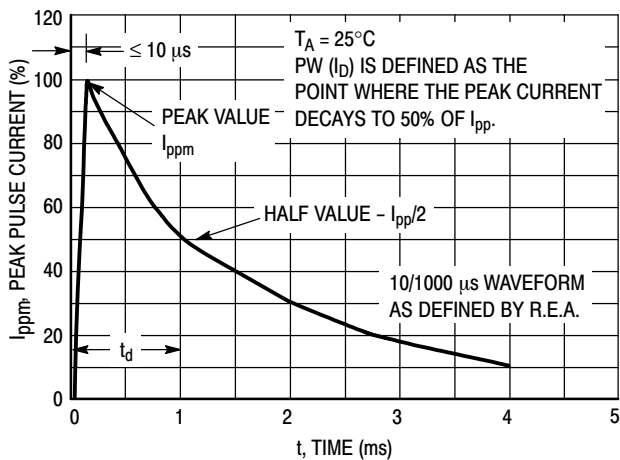

Figure 11. Pulse Waveform

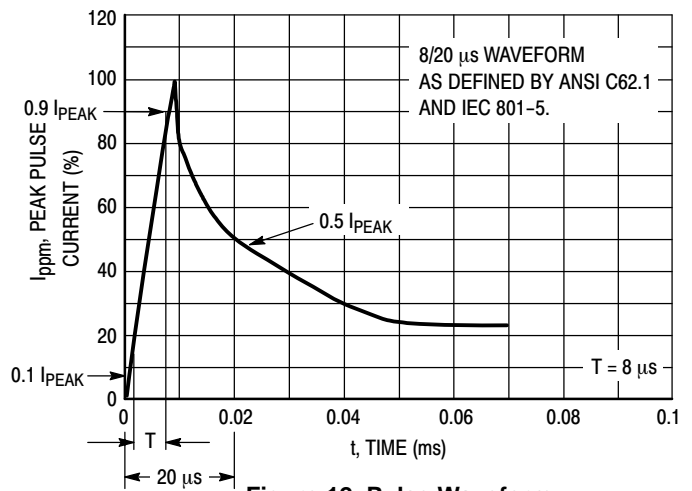
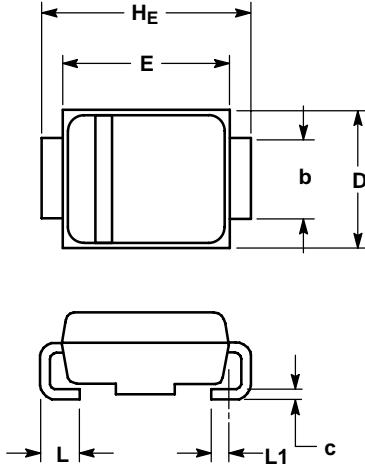

Figure 12. Pulse Waveform

1SMB5913BT3 Series

PACKAGE DIMENSIONS

SMB
CASE 403A-03
ISSUE E



- NOTES:
1. DIMENSIONING AND TOLERANCING PER ANSI Y14.5M, 1982.
 2. CONTROLLING DIMENSION: INCH.
 3. D DIMENSION SHALL BE MEASURED WITHIN DIMENSION P.

DIM	MILLIMETERS			INCHES		
	MIN	NOM	MAX	MIN	NOM	MAX
A	1.90	2.13	2.41	0.075	0.084	0.095
A1	0.05	0.10	0.15	0.002	0.004	0.006
b	1.96	2.03	2.11	0.077	0.080	0.083
c	0.15	0.23	0.30	0.006	0.009	0.012
D	3.30	3.56	3.81	0.130	0.140	0.150
E	4.06	4.32	4.57	0.160	0.170	0.180
HE	5.21	5.44	5.59	0.205	0.214	0.220
L	0.76	1.02	1.27	0.030	0.040	0.050
L1	0.51 REF			0.020 REF		

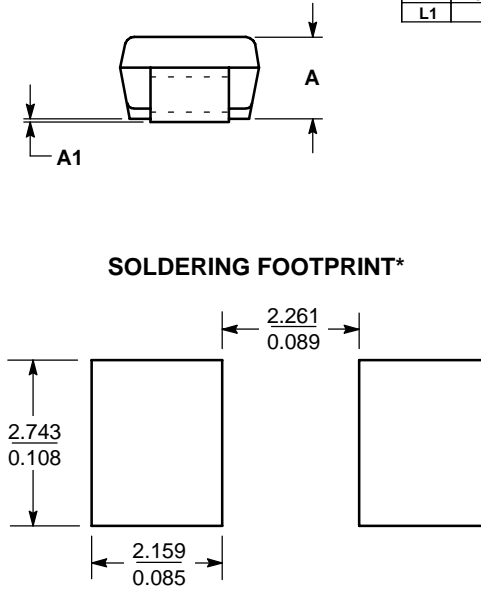

SCALE 8:1 (mm/inches)

*For additional information on our Pb-Free strategy and soldering details, please download the ON Semiconductor Soldering and Mounting Techniques Reference Manual, SOLDERRM/D.

ON Semiconductor and are registered trademarks of Semiconductor Components Industries, LLC (SCILLC). SCILLC reserves the right to make changes without further notice to any products herein. SCILLC makes no warranty, representation or guarantee regarding the suitability of its products for any particular purpose, nor does SCILLC assume any liability arising out of the application or use of any product or circuit, and specifically disclaims any and all liability, including without limitation special, consequential or incidental damages. "Typical" parameters which may be provided in SCILLC data sheets and/or specifications can and do vary in different applications and actual performance may vary over time. All operating parameters, including "Typicals" must be validated for each customer application by customer's technical experts. SCILLC does not convey any license under its patent rights nor the rights of others. SCILLC products are not designed, intended, or authorized for use as components in systems intended for surgical implant into the body, or other applications intended to support or sustain life, or for any other application in which the failure of the SCILLC product could create a situation where personal injury or death may occur. Should Buyer purchase or use SCILLC products for any such unintended or unauthorized application, Buyer shall indemnify and hold SCILLC and its officers, employees, subsidiaries, affiliates, and distributors harmless against all claims, costs, damages, and expenses, and reasonable attorney fees arising out of, directly or indirectly, any claim of personal injury or death associated with such unintended or unauthorized use, even if such claim alleges that SCILLC was negligent regarding the design or manufacture of the part. SCILLC is an Equal Opportunity/Affirmative Action Employer. This literature is subject to all applicable copyright laws and is not for resale in any manner.

PUBLICATION ORDERING INFORMATION

LITERATURE FULFILLMENT:
Literature Distribution Center for ON Semiconductor
P.O. Box 5163, Denver, Colorado 80217 USA
Phone: 303-675-2175 or 800-344-3860 Toll Free USA/Canada
Fax: 303-675-2176 or 800-344-3867 Toll Free USA/Canada
Email: orderlit@onsemi.com

N. American Technical Support: 800-282-9855 Toll Free
USA/Canada
Europe, Middle East and Africa Technical Support:
Phone: 421 33 790 2910
Japan Customer Focus Center
Phone: 81-3-5773-3850

ON Semiconductor Website: www.onsemi.com

Order Literature: <http://www.onsemi.com/orderlit>

For additional information, please contact your local Sales Representative