

12.0-27.0 GHz GaAs MMIC Buffer Amplifier, QFN

Features

- ✕ Excellent Transmit LO/Output Buffer Stage
- ✕ On-Chip ESD Protection
- ✕ 16.0 dB Small Signal Gain
- ✕ +22.0 dBm P1dB Compression Point
- ✕ RoHS Compliant SMD, 3x3 mm QFN Package
- ✕ 100% RF, DC, and Output Power Testing



General Description

Mimix Broadband's three stage 12.0-27.0 GHz GaAs MMIC buffer amplifier has a small signal gain of 16.0 dB with a +22.0 dBm P1dB output compression point across much of the band. This MMIC uses Mimix Broadband's 0.15 μm GaAs PHEMT device model technology, and is based upon electron beam lithography to ensure high repeatability and uniformity. The device comes in a RoHS compliant 3x3mm QFN Surface Mount Package offering excellent RF and thermal properties. This device is well suited for Millimeter-wave Point-to-Point Radio, LMDS, SATCOM and VSAT applications.

Absolute Maximum Ratings

| | |
|----------------------------|--------------------------------|
| Supply Voltage (Vd) | +6.0 VDC |
| Supply Current (Id1,2,3) | 90, 260 mA |
| Gate Bias Voltage (Vg) | +0.3 VDC |
| Input Power (Pin) | +12.0 dBm |
| Storage Temperature (Tstg) | -65 to +165 °C |
| Operating Temperature (Ta) | -55 to MTTF Graph ¹ |
| Channel Temperature (Tch) | MTTF Graph ¹ |

(1) Channel temperature affects a device's MTTF. It is recommended to keep channel temperature as low as possible for maximum life.

Electrical Characteristics (Ambient Temperature T = 25 °C)

| Parameter | Units | Min. | Typ. | Max. |
|--|-------|------|--------|------|
| Frequency Range (f) | GHz | 12.0 | - | 27.0 |
| Input Return Loss (S11) | dB | - | 10.0 | - |
| Output Return Loss (S22) | dB | - | 10.0 | - |
| Small Signal Gain (S21) | dB | - | 16.0 | - |
| Gain Flatness ($\Delta S21$) | dB | - | +/-3.0 | - |
| Reverse Isolation (S12) | dB | - | 45.0 | - |
| Noise Figure (NF) | dB | - | 5.0 | - |
| Output Power for 1dB Compression (P1dB) ² | dBm | - | +22.0 | - |
| Drain Bias Voltage (Vd1,2) | VDC | - | +5.0 | +5.5 |
| Gate Bias Voltage (Vg1,2) | VDC | -1.0 | -0.6 | 0.0 |
| Supply Current (Id1) (Vd=5.0V, Vg=-0.6V Typical) | mA | - | 60 | 75 |
| Supply Current (Id2) (Vd=5.0V, Vg=-0.6V Typical) | mA | - | 180 | 220 |

(2) Measured using constant current.

12.0-27.0 GHz GaAs MMIC Buffer Amplifier, QFN

February 2007 - Rev 08-Feb-07

BI009-QT
RoHS

Buffer Amplifier Measurements

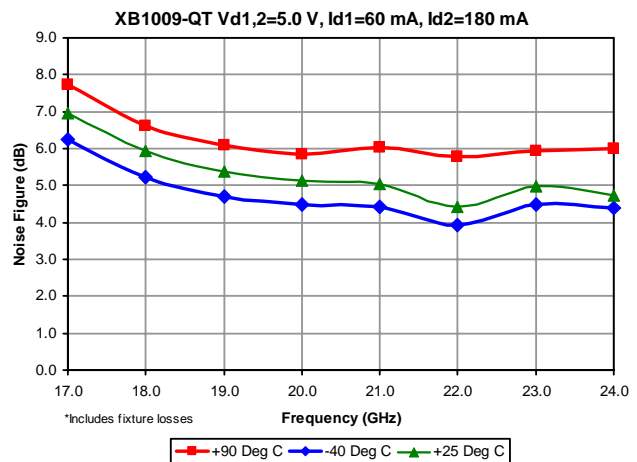
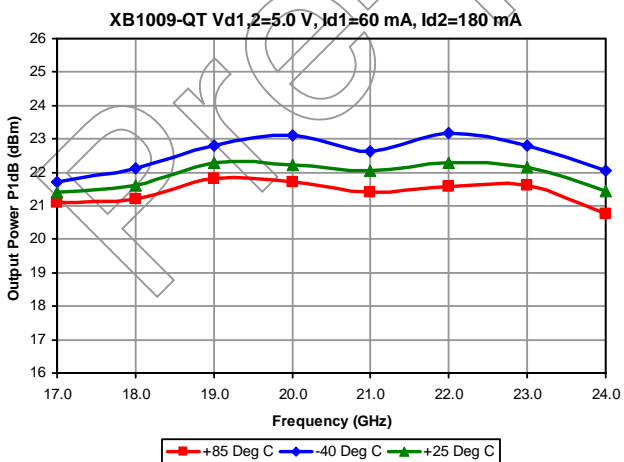
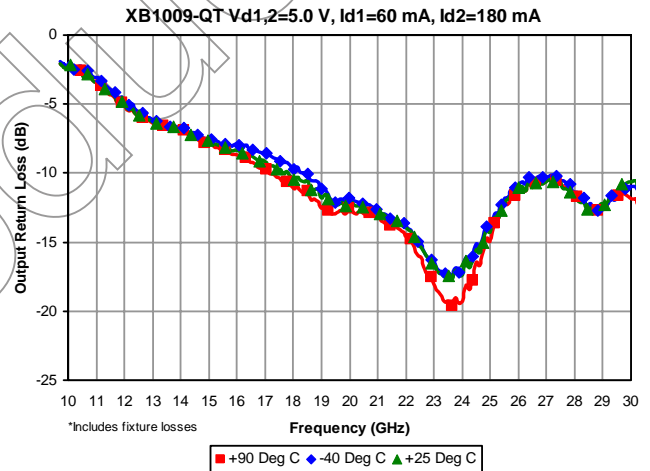
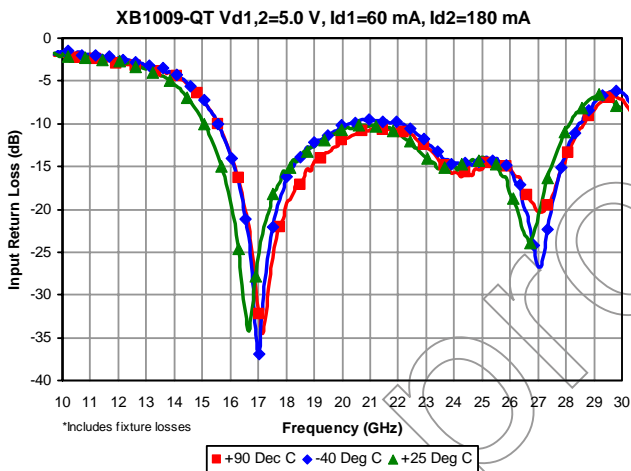
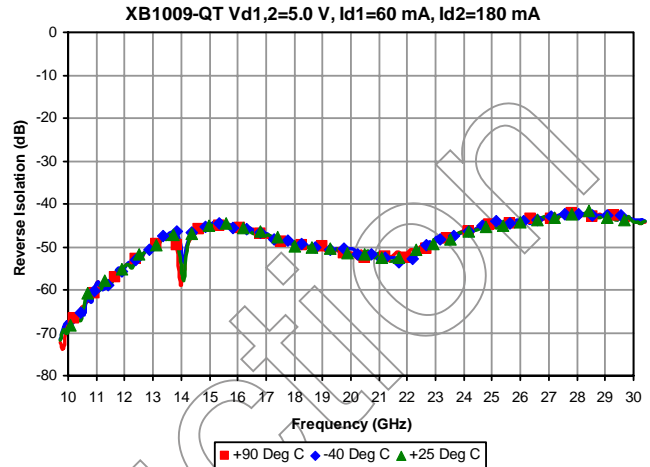
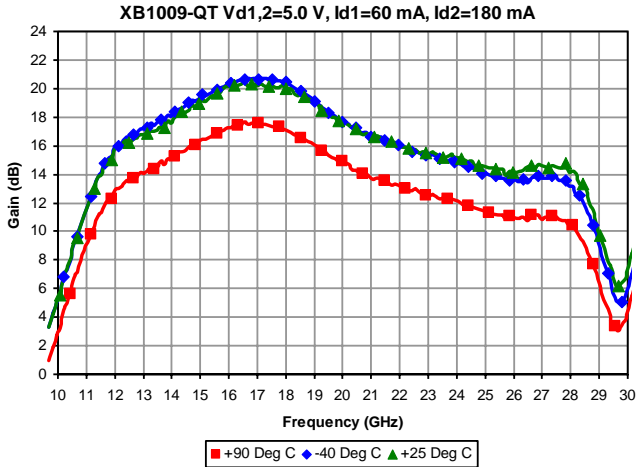

12.0-27.0 GHz GaAs MMIC Buffer Amplifier, QFN

Buffer Amplifier Measurements (cont.)

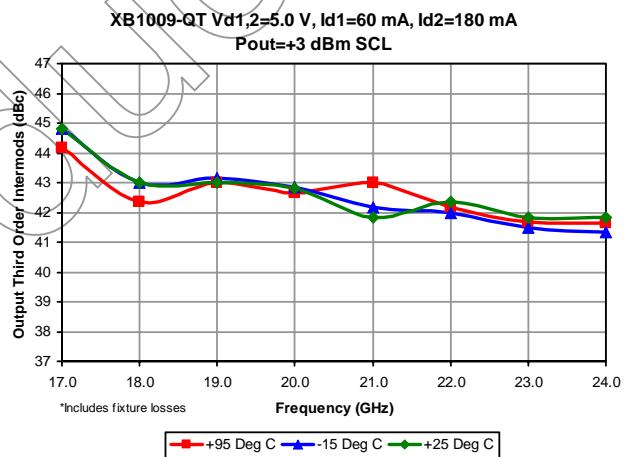
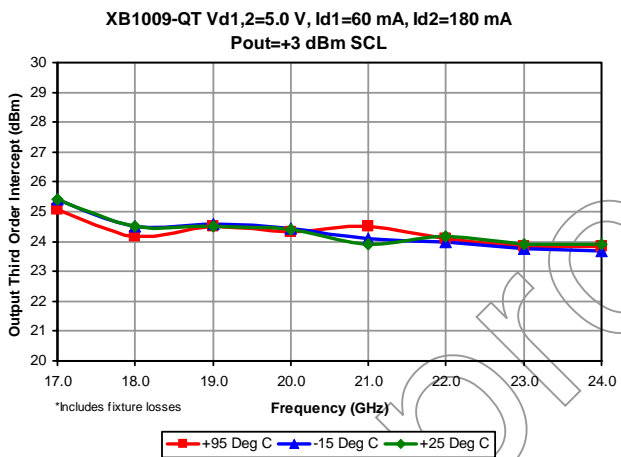
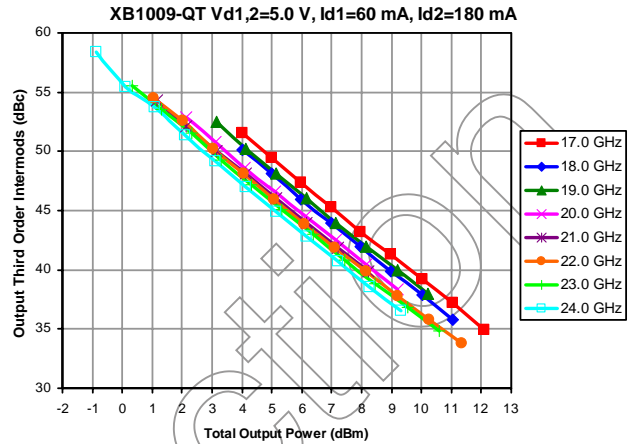
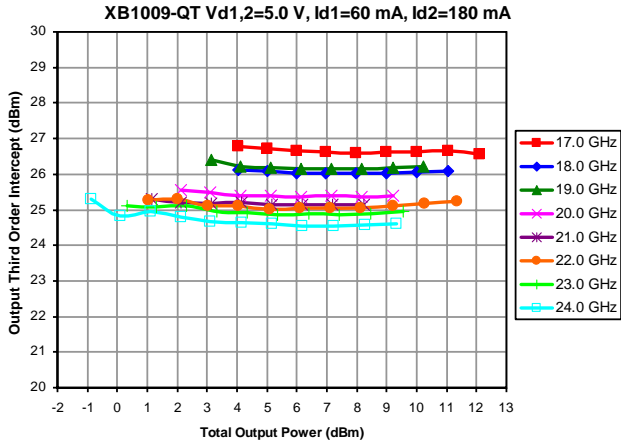

12.0-27.0 GHz GaAs MMIC Buffer Amplifier, QFN

February 2007 - Rev 08-Feb-07

BI009-QT
RoHS

Buffer Amplifier Measurements (cont.)

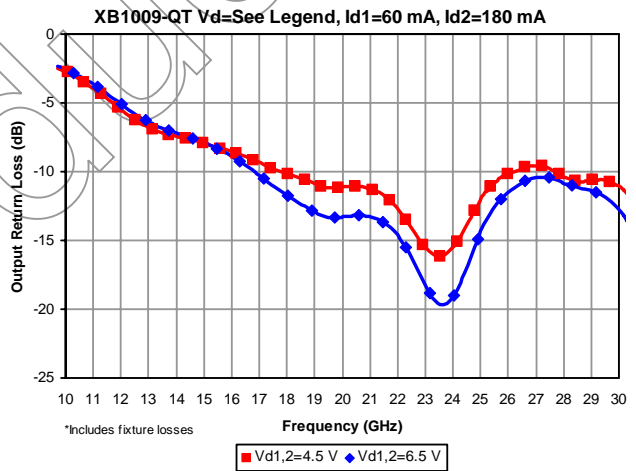
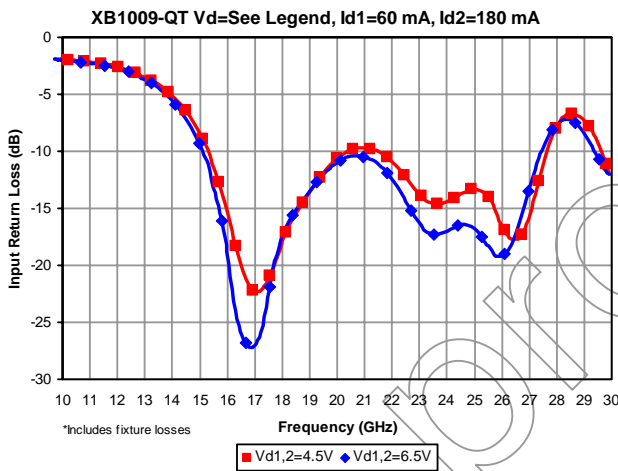
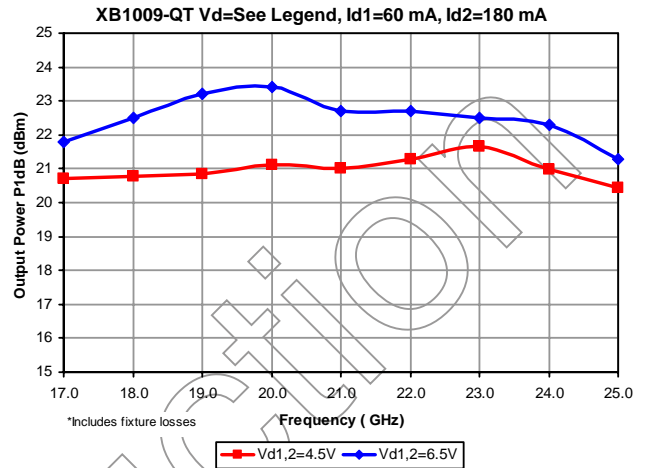
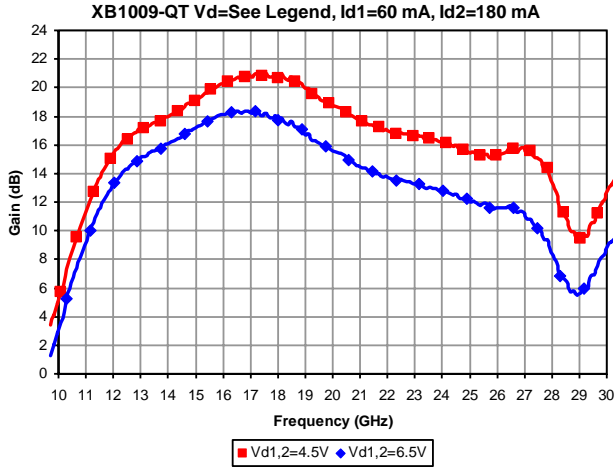

12.0-27.0 GHz GaAs MMIC Buffer Amplifier, QFN

February 2007 - Rev 08-Feb-07

BI009-QT
RoHS

Package Dimensions/Layout

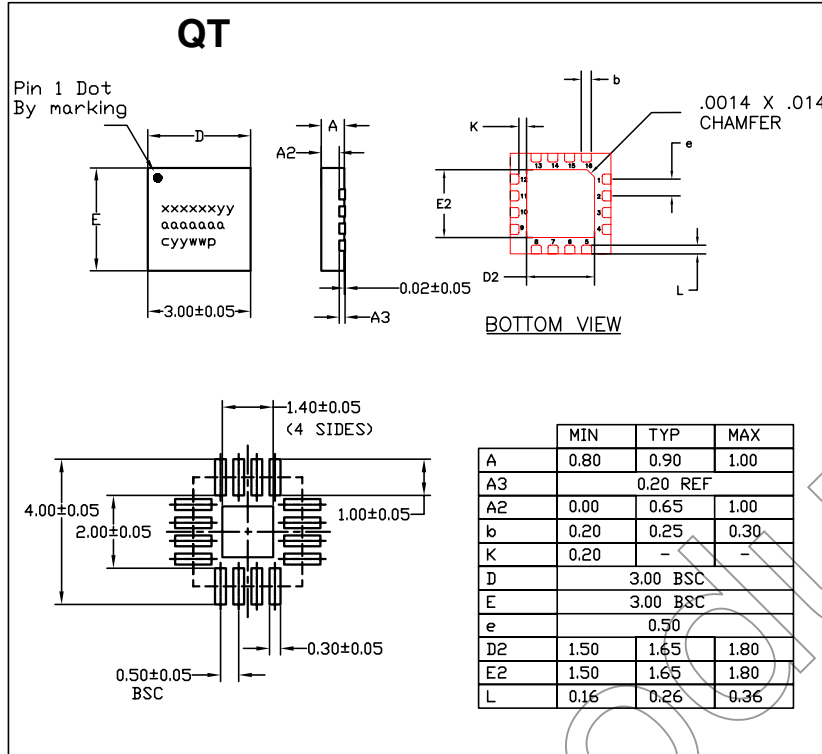

| Pin | Description |
|-------|-------------|
| 1,2 | Ground |
| 3 | RF Input |
| 4 | Ground |
| 5 | Vg1 |
| 6 | Vg2 |
| 7,8 | Ground |
| 9 | Ground |
| 10 | RF Output |
| 11,12 | Ground |
| 13 | Vd2 |
| 14 | Vd1 |
| 15,16 | Ground |

Functional Block Diagram/Board Layout

Bypass Capacitors - See App Note [2]

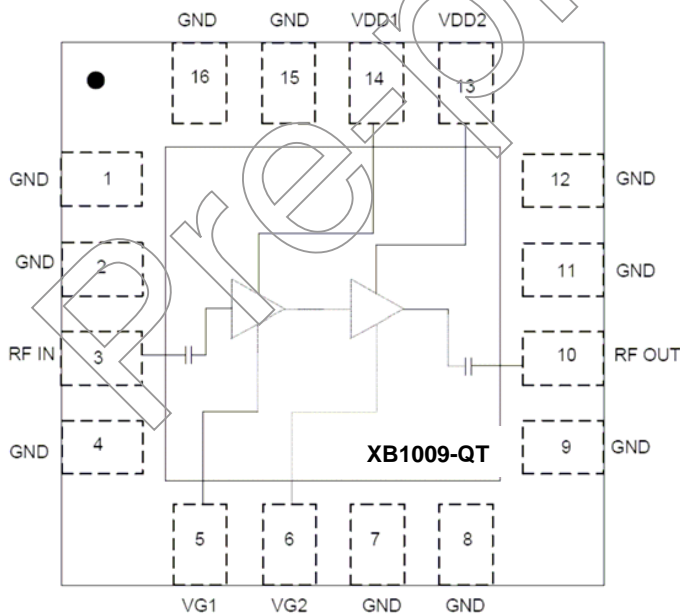

12.0-27.0 GHz GaAs MMIC Buffer Amplifier, QFN

Mimix
BROADBAND™

February 2007 - Rev 08-Feb-07

X BI009-QT
X RoHS

App Note [1] Biasing - It is recommended to separately bias each amplifier stage Vd1 through Vd2 at Vd(1,2)=5.0V with Id1=60 mA and Id2=180 mA. Separate biasing is recommended if the amplifier is to be used at high levels of saturation, where gate rectification will alter the effective gate control voltage. For non-critical applications it is possible to parallel all stages and adjust the common gate voltage for a total drain current Id(total)=240 mA. It is also recommended to use active biasing to keep the currents constant as the RF power and temperature vary; this gives the most reproducible results. Depending on the supply voltage available and the power dissipation constraints, the bias circuit may be a single transistor or a low power operational amplifier, with a low value resistor in series with the drain supply used to sense the current. The gate of the pHEMT is controlled to maintain correct drain current and thus drain voltage. The typical gate voltage needed to do this is -0.6V. Typically the gate is protected with Silicon diodes to limit the applied voltage. Also, make sure to sequence the applied voltage to ensure negative gate bias is available before applying the positive drain supply.

App Note [2] Bias Arrangement -

For Parallel Stage Bias (Recommended for general applications) -- The same as Individual Stage Bias but all the drain or gate pad DC bypass capacitors (~100-200 pF) can be combined. Additional DC bypass capacitance (~0.01 uF) is also recommended to all DC or combination (if gate or drains are tied together) of DC bias pads.

For Individual Stage Bias (Recommended for saturated applications) - Each DC pad (Vd1,2 and Vg1,2) needs to have DC bypass capacitance (~100-200 pF) as close to the device as possible. Additional DC bypass capacitance (~0.01 uF) is also recommended.

Pre-product

12.0-27.0 GHz GaAs MMIC Buffer Amplifier, QFN

MTTF Tables (TBD)

These numbers were calculated based on accelerated life test information and thermal model analysis received from the fabricating foundry.

| Backplate Temperature | Channel Temperature | Rth | MTTF Hours | FITs |
|-----------------------|---------------------|-----|------------|------|
| 55 deg Celsius | Deg Celsius | C/W | E+ | E+ |
| 75 deg Celsius | Deg Celsius | C/W | E+ | E+ |
| 95 deg Celsius | Deg Celsius | C/W | E+ | E+ |

Bias Conditions: Vd1,2=5.0V, Id1=60 mA, Id2=180 mA

Typical Application

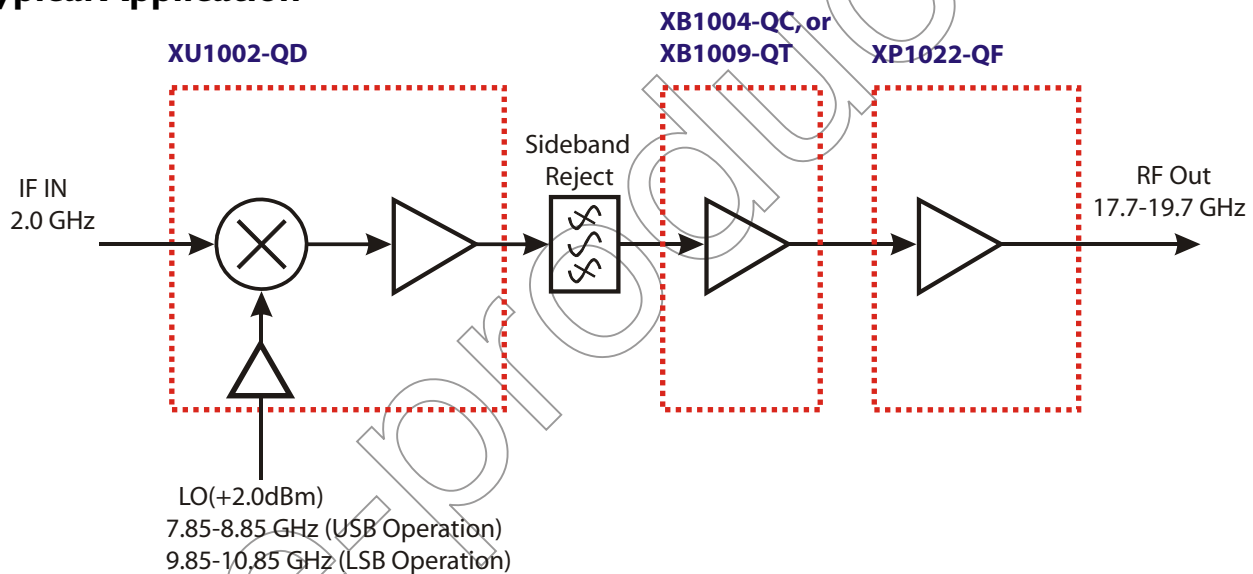

Mimix Broadband MMIC-based 18.0-25.0 GHz Transmitter Block Diagram

(Changing-LO and IF frequencies as required allows design to operate as high as 25.0 GHz)

Mimix Broadband's 18.0-25.0 GHz XU1002 GaAs MMIC Transmitter can be used in saturated radio applications and linear modulation schemes up to 16 QAM. The transmitter can be used in upper and lower sideband applications from 18.0-25.0 GHz.

12.0-27.0 GHz GaAs MMIC Buffer Amplifier, QFN

February 2007 - Rev 08-Feb-07

Handling and Assembly Information

CAUTION! - Mimix Broadband MMIC Products contain gallium arsenide (GaAs) which can be hazardous to the human body and the environment. For safety, observe the following procedures:

- Do not ingest.
- Do not alter the form of this product into a gas, powder, or liquid through burning, crushing, or chemical processing as these by-products are dangerous to the human body if inhaled, ingested, or swallowed.
- Observe government laws and company regulations when discarding this product. This product must be discarded in accordance with methods specified by applicable hazardous waste procedures.

Life Support Policy - Mimix Broadband's products are not authorized for use as critical components in life support devices or systems without the express written approval of the President and General Counsel of Mimix Broadband. As used herein: (1) Life support devices or systems are devices or systems which, (a) are intended for surgical implant into the body, or (b) support or sustain life, and whose failure to perform when properly used in accordance with instructions for use provided in the labeling, can be reasonably expected to result in a significant injury to the user. (2) A critical component is any component of a life support device or system whose failure to perform can be reasonably expected to cause the failure of the life support device or system, or to affect its safety or effectiveness.

Package Attachment - This packaged product from Mimix Broadband is provided as a rugged surface mount package compatible with high volume solder installation. Vacuum tools or other suitable pick and place equipment may be used to pick and place this part. Care should be taken to ensure that there are no voids or gaps in the solder connection so that good RF, DC and ground connections are maintained. Voids or gaps can eventually lead not only to RF performance degradation, but reduced reliability and life of the product due to thermal stress.

Typical Reflow Profiles

| Reflow Profile | SnPb | Pb Free |
|---------------------------------|-------------------------|-------------------------|
| Ramp Up Rate | 3-4 °C/sec | 3-4 °C/sec |
| Activation Time and Temperature | 60-120 sec @ 140-160 °C | 60-180 sec @ 170-200 °C |
| Time Above Melting Point | 60-150 sec | 60-150 sec |
| Max Peak Temperature | 240 °C | 265 °C |
| Time Within 5 °C of Peak | 10-20 sec | 10-20 sec |
| Ramp Down Rate | 4-6 °C/sec | 4-6 °C/sec |

Factory Automation and Identification

| Mimix Designator | Package Type | Number of leads offered | W Tape Width | P ₁ Component Pitch | P ₀ Hole Pitch | Reel Diameter | Units per Reel |
|------------------|--------------|-------------------------|--------------|--------------------------------|---------------------------|---------------|----------------|
| -QT | QFN (3x3mm) | 16 | 12mm | 8mm | 4mm | 329mm (13in) | 2000 |

Component Orientation: Parts are to be oriented with the PIN 1 closest to the tape's round sprocket holes on the tape's trailing edge.

Note: Tape and Reel packaging is ordered with a -000T suffix. Package is available in 500 unit reels through designated sales channels. Minimum order quantities should be discussed with your local sales representative.

Mimix Lead-Free RoHS Compliant Program - Mimix has an active program in place to meet customer and governmental requirements for eliminating lead (Pb) and other environmentally hazardous materials from our products. All Mimix RoHS compliant components are form, fit and functional replacements for their non-RoHS equivalents. Lead plating of our RoHS compliant parts is 100% matt tin (Sn) over copper alloy and is backwards compatible with current standard SnPb low-temperature reflow processes as well as higher temperature (260°C reflow) "Pb Free" processes.

Part Number for Ordering

XB1009-QT-0G00
XB1009-QT-EV1

Description

Matte Tin plated RoHS compliant 3x3 16L QFN surface mount package in bulk quantity
XB1009-QT evaluation board

We also offer this part with SnPb (Tin-Lead) or NiPdAu plating. Please contact your regional sales manager for more information regarding different plating types.