

# InGaAs PIN photodiode G8423/G8373/G5853 series

Long wavelength type (up to 2.6  $\mu\text{m}$ )

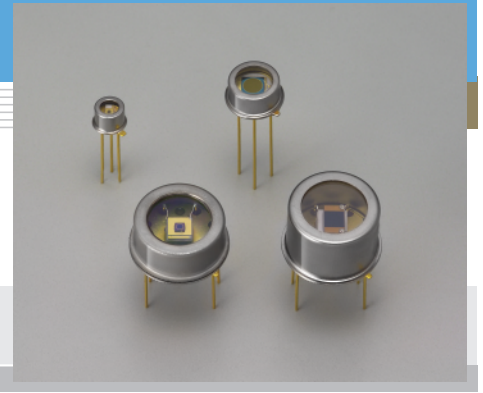

## Features

- Long cut-off wavelength: 2.6  $\mu\text{m}$
- 3-pin TO-18 package: low price
- Thermoelectrically cooled TO-8 package: low dark current
- Active area:  $\phi 0.3$  to  $\phi 3$  mm

## Applications

- Gas analysis
- Spectrophotometer
- NIR (near infrared) photometry

## Specifications / Absolute maximum ratings

Type No.	Dimensional outline	Package	Cooling	Active area (mm)	Absolute maximum ratings				
					Thermistor power dissipation (mW)	TE-cooler allowable current (A)	Reverse voltage $V_R$ (V)	Operating temperature $T_{opr}$ ( $^{\circ}\text{C}$ )	Storage temperature $T_{stg}$ ( $^{\circ}\text{C}$ )
G8423-03	①	TO-18	Non-cooled	$\phi 0.3$	-	-	2	-40 to +85	-55 to +125
G8423-05				$\phi 0.5$					
G8373-01				$\phi 1$					
G8373-03	②	TO-5		$\phi 3$					
G5853-103	③	TO-8	One-stage TE-cooled	$\phi 0.3$	0.2	1.5	2	-40 to +70	-55 to +85
G5853-11				$\phi 1$					
G5853-13				$\phi 3$					
G5853-203	④	TO-8	Two-stage TE-cooled	$\phi 0.3$	0.2	1.0	2	-40 to +70	-55 to +85
G5853-21				$\phi 1$					
G5853-23				$\phi 3$					

## Electrical and optical characteristics (Typ. unless otherwise noted)

Type No.	Measurement condition	Spectral response range $\lambda$ ( $\mu\text{m}$ )	Peak sensitivity wavelength $\lambda_p$ ( $\mu\text{m}$ )	Photo sensitivity $S$ $\lambda = \lambda_p$ (A/W)	Dark current $I_D$ $V_R = 1$ V		Cut-off frequency $f_c$ $V_R = 1$ V $R_L = 50$ $\Omega$ -3 dB (MHz)	Terminal capacitance $C_t$ $V_R = 1$ V $f = 1$ MHz (pF)	Shunt resistance $R_{sh}$ $V_R = 10$ mV (k $\Omega$ )	$D^*$ $\lambda = \lambda_p$ (cm $\cdot$ Hz $^{1/2}$ /W)	NEP $\lambda = \lambda_p$ (W/Hz $^{1/2}$ )
	Element temperature ( $^{\circ}\text{C}$ )				Typ. ( $\mu\text{A}$ )	Max. ( $\mu\text{A}$ )					
	G8423-03	25	1.2 to 2.6	2.3	1.1	2	20	60	40	30	$5 \times 10^{10}$
G8423-05	5					50	50	60	15	$1 \times 10^{-12}$	
G8373-01	15					75	15	200	3	$2 \times 10^{-12}$	
G8373-03	150					1500	1.5	1800	0.3	$8 \times 10^{-12}$	
G5853-103	-10	1.2 to 2.57	2.3	1.1	0.2	2	60	40	300	$1 \times 10^{11}$	$3 \times 10^{-13}$
G5853-11					1.5	7.5	15	200	30		$7 \times 10^{-13}$
G5853-13					15	150	1.5	1800	3		$2 \times 10^{-12}$
G5853-203	-20	1.2 to 2.55	2.3	1.1	0.1	1	60	40	600	$2 \times 10^{11}$	$2 \times 10^{-13}$
G5853-21					0.8	4	15	200	60		$5 \times 10^{-13}$
G5853-23					7.5	75	1.5	1800	6		$1.8 \times 10^{-12}$

■ Spectral response

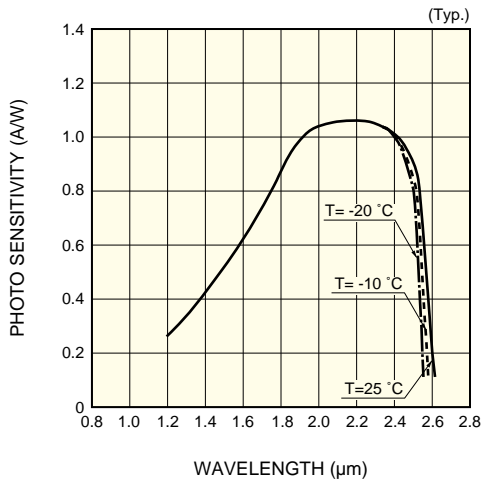

KIRDB0216EA

■ Photo sensitivity temperature characteristic

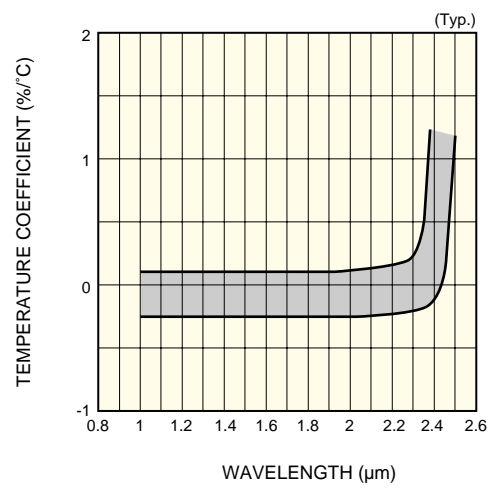

KIRDB0206EA

■ Dark current vs. reverse voltage

Non-cooled type

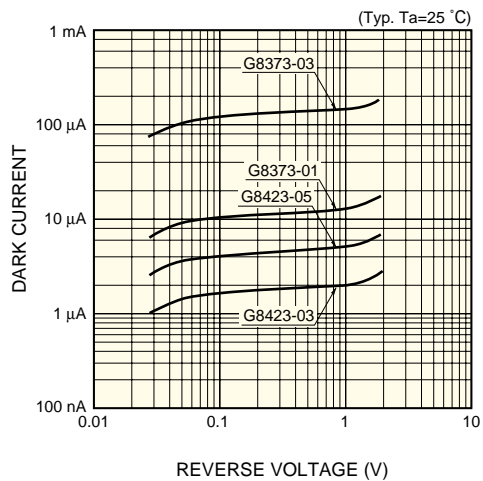

KIRDB0238EA

TE-cooled type

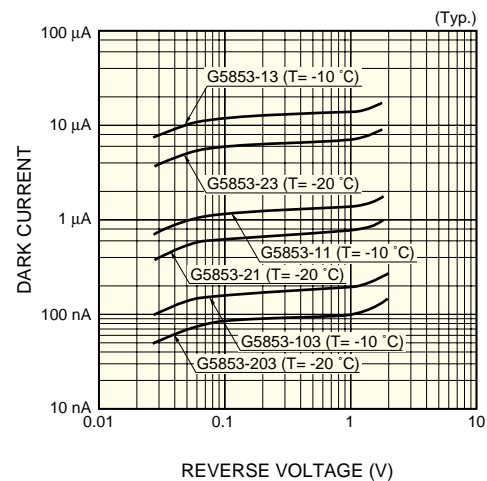

KIRDB0218EA

■ Terminal capacitance vs. reverse voltage

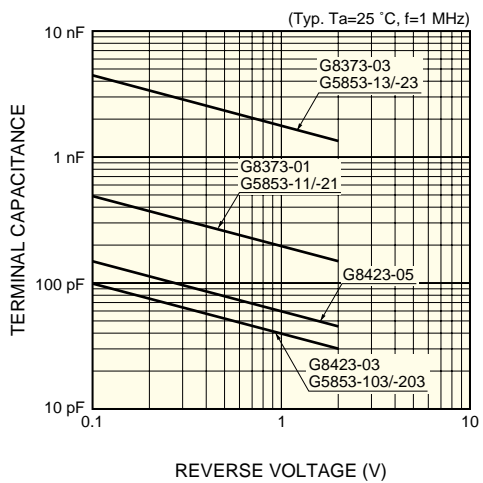

KIRDB0239EA

■ Shunt resistance vs. element temperature

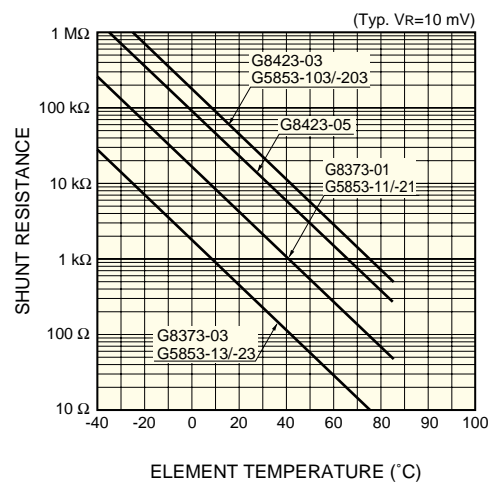

KIRDB0240EA

■ Thermistor temperature characteristic

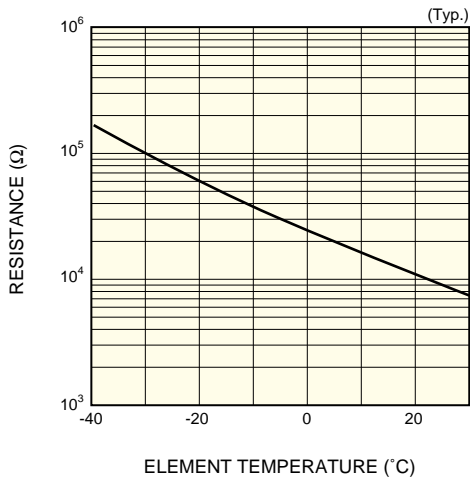

KIRDB0116EA

■ Cooling characteristics of TE-cooler

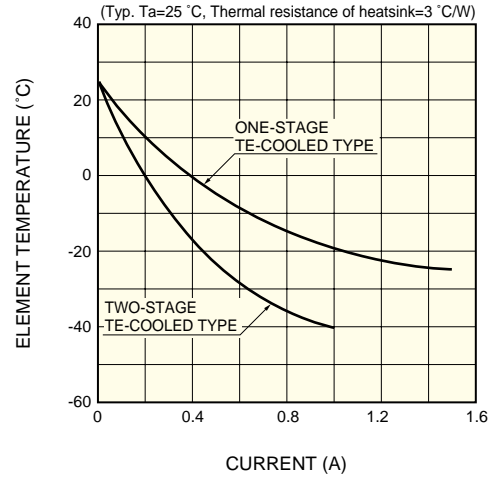

KIRDB0231EA

■ Current vs. voltage characteristics of TE-cooler

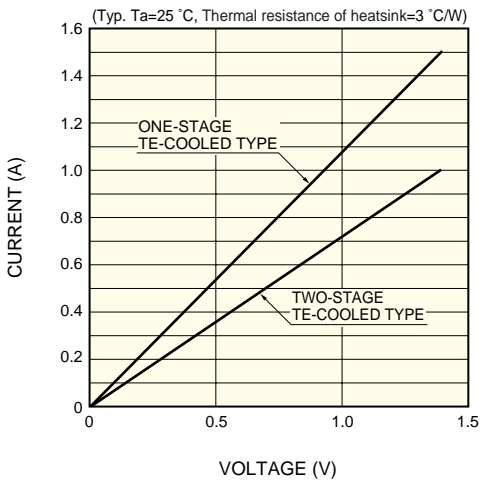

KIRDB0115EA

■ Dimensional outlines (unit: mm)

① G8423-03/-05, G8373-01

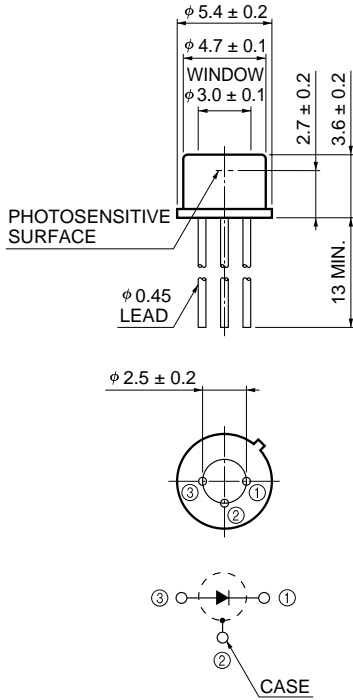

KIRDA0150EA

② G8373-03

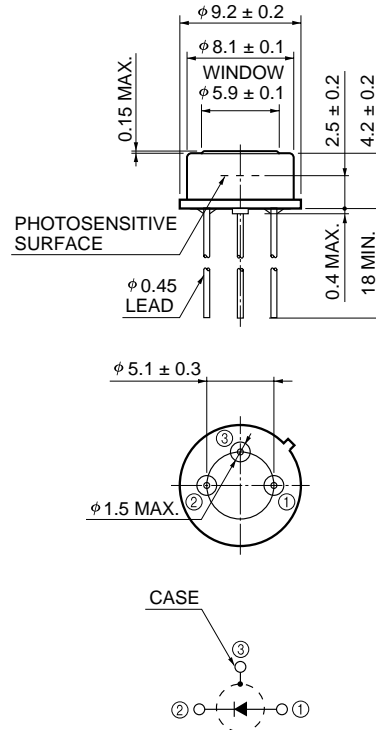

KIRDA0151EA

③ G5853-103/-11/-13

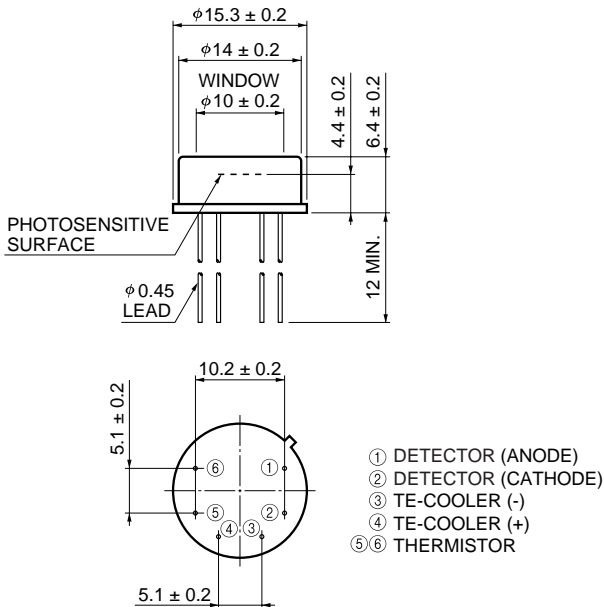

KIRDA0029EB

④ G5853-203/-21/-23

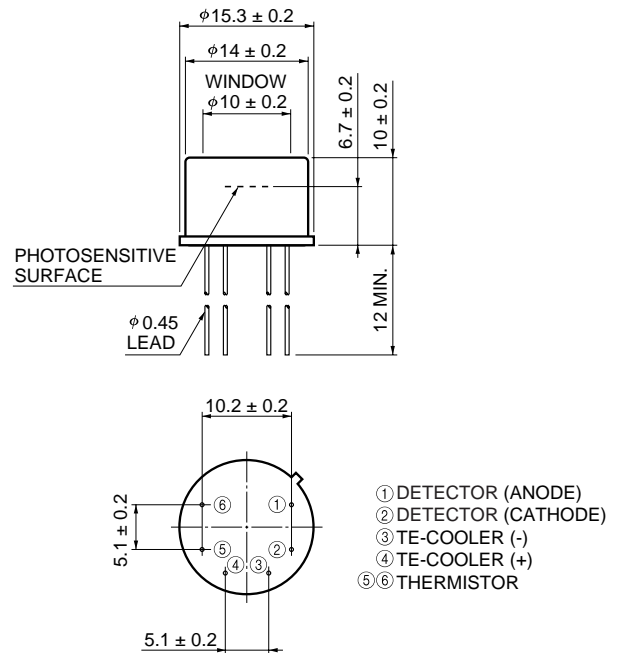

KIRDA0031EB

## HAMAMATSU

Information furnished by HAMAMATSU is believed to be reliable. However, no responsibility is assumed for possible inaccuracies or omissions. Specifications are subject to change without notice. No patent rights are granted to any of the circuits described herein. ©2001 Hamamatsu Photonics K.K.

HAMAMATSU PHOTONICS K.K., Solid State Division

1126-1 Ichino-cho, Hamamatsu City, 435-8558 Japan, Telephone: (81) 053-434-3311, Fax: (81) 053-434-5184, <http://www.hamamatsu.com>

U.S.A.: Hamamatsu Corporation, 360 Foothill Road, P.O. Box 6910, Bridgewater, N.J. 08807-0910, U.S.A., Telephone: (1) 908-231-0960, Fax: (1) 908-231-1218

Germany: Hamamatsu Photonics Deutschland GmbH, Arzbergerstr. 10, D-82211 Herrsching am Ammersee, Germany, Telephone: (49) 08152-3750, Fax: (49) 08152-2658

France: Hamamatsu Photonics France S.A.R.L.: 8, Rue du Saule Trapu, Parc du Moulin de Massy, 91882 Massy Cedex, France, Telephone: 33-(1) 69 53 71 00, Fax: 33-(1) 69 53 71 10

United Kingdom: Hamamatsu Photonics UK Limited, 2 Howard Court, 10 Tewin Road, Welwyn Garden City, Hertfordshire AL7 1BW, United Kingdom, Telephone: (44) 1707-294888, Fax: (44) 1707-325777

North Europe: Hamamatsu Photonics Norden AB, Smidsvågen 12, SE-171 41 Solna, Sweden, Telephone: (46) 8-509-031-00, Fax: (46) 8-509-031-01

Italy: Hamamatsu Photonics Italia S.R.L.: Strada della Moia, 1/E, 20020 Arese, (Milano), Italy, Telephone: (39) 02-935-81-733, Fax: (39) 02-935-81-741