

3875081 G E SOLID STATE  
High-Voltage Power Transistors

File Number 321

2N5239, 2N5240

High-Voltage, Silicon N-P-N Transistors

For High-Speed Switching and Linear-Amplifier Applications in Industrial and Commercial Service

Features:

- High voltage ratings:  $V_{CE(sus)}$   
=350 V,  $R_{BE} \leq 50 \Omega$  (2N5240)  
=250 V,  $R_{BE} \leq 50 \Omega$  (2N5239)
- High power dissipation rating:  
 $P_T = 100$  W at  $V_{CE} = 125$  V,  $T_C = 25^\circ$  C
- For switching applications where circuit values and operating conditions require a transistor with a high second-breakdown rating ( $I_{S/B}$ ) (limit line begins at 125 V)
- Exceptional second-breakdown: 0.8 A at  $V_{CE} = 125$  V
- Maximum area-of-operation curves for dc and pulse operation

The RCA-2N5239 and 2N5240\* are multi epitaxial silicon n-p-n power transistors.

The high breakdown voltage ratings and exceptional second-breakdown capabilities of these transistors make them especially suitable for use in series regulators, power amplifiers, inverters, deflection circuits, switching regulators, and high-voltage bridge amplifiers.

These types differ in breakdown voltage and leakage current values. The 2N5239 and 2N5240 are supplied in steel JEDEC TO-204AA hermetic packages.

\* RCA Dev. No. TA2765 and TA2765A, respectively.

TERMINAL DESIGNATIONS

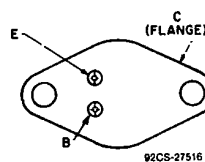

JEDEC TO-204AA

MAXIMUM RATINGS, Absolute-Maximum Values:

	2N5239	2N5240	
$V_{CEO}$ .....	300	375	V
$V_{CE(sus)}$ $R_{BE} \leq 50 \Omega$ .....	250	350	V
$V_{CE(sus)}$ .....	225	300	V
$V_{EBO}$ .....		6	V
$I_C$ .....		5	A
$I_B$ .....		2	A
$P_T$ .....		100	W
$T_C \leq 25^\circ$ C and $V_{CE} \leq 125$ V .....		See Fig. 1	
$T_C \leq 25^\circ$ C and $V_{CE} \leq 125$ V .....		See Fig. 1	
$T_C > 25^\circ$ C and $V_{CE} > 125$ V .....		-65 to 200	$^\circ$ C
$T_{stg}, T_J$ .....			
$T_L$ At distance $\geq 1/32$ in. (0.8 mm) from seating plane for 10 s max. ....		230	$^\circ$ C

\* In accordance with JEDEC registration data

2N5239, 2N5240

ELECTRICAL CHARACTERISTICS, At Case Temperature ( $T_c$ ) = 25°C unless otherwise specified

CHARACTERISTIC	TEST CONDITIONS				LIMITS				UNITS
	VOLTAGE V dc		CURRENT A dc		2N5239		2N5240		
	V <sub>CE</sub>	V <sub>BE</sub>	I <sub>c</sub>	I <sub>e</sub>	Min.	Max.	Min.	Max.	
I <sub>CEO</sub>	200			0	—	5	—	2	mA
I <sub>CEV</sub>	300	-1.5			—	4	—	—	
	375	-1.5			—	—	—	2	
( $T_c = 150^\circ\text{C}$ )	300	-1.5			—	5	—	3	
I <sub>EBO</sub> (V <sub>EB</sub> = 5 V) (V <sub>EB</sub> = 6 V)			0		—	5	—	1	mA
			0		—	20	—	20	
V <sub>EBO</sub>				0.02	6	—	6	—	V
V <sub>CEO(sus)</sub> <sup>a</sup>			0.2 <sup>b</sup>		225	—	300	—	
V <sub>CER(sus)</sub> <sup>a</sup> (R <sub>BE</sub> ≤ 50 Ω)			0.2 <sup>b</sup>		250	—	350	—	
h <sub>FE</sub>	10		0.4 <sup>b</sup>		20	80	20	80	
	10		2 <sup>b</sup>		20	80	20	80	
	10		4.5 <sup>b</sup>		5	—	5	—	
V <sub>BE</sub>	10		2 <sup>b</sup>		—	3	—	3	V
V <sub>CE(sat)</sub>			2 <sup>b</sup> 4.5 <sup>b</sup>	0.25 1.125	— —	2.5 5	— —	2.5 5	
I <sub>s</sub> /I <sub>b</sub> (t = 1 s)	125				0.8	—	0.8	—	A
h <sub>ie</sub>   (f = 1 MHz)	10		0.2		2	—	2	—	
h <sub>ie</sub> (f = 1 kHz)	10		4		20	—	20	—	
f <sub>T</sub>	10		0.2		2	—	2	—	MHz
C <sub>obo</sub> (f = 1 MHz)	10 <sup>c</sup>		0		—	250	—	250	pF
R <sub>θJC</sub>					—	1.75	—	1.75	°C/W

\* In accordance with JEDEC registration data.

<sup>a</sup> CAUTION: The sustaining voltages V<sub>CEO(sus)</sub> and V<sub>CER(sus)</sub> MUST NOT be measured on a curve tracer.

<sup>b</sup> Pulsed; pulse duration ≤ 350 μs, duty factory ≤ 2%.

<sup>c</sup> V<sub>ce</sub> value.

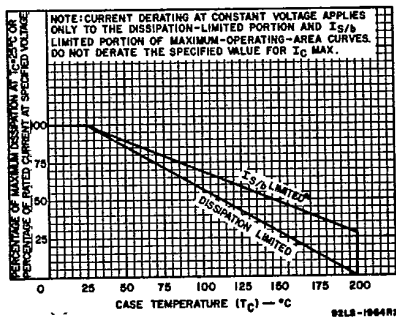

Fig. 1 - Derating curves for both types.

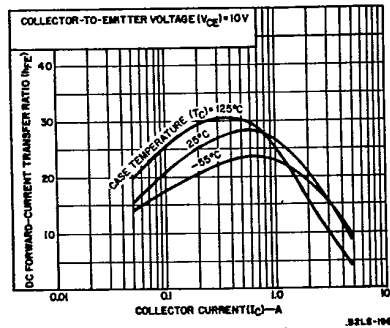

Fig. 2 - Typical dc beta characteristics for both types.

2N5239, 2N5240

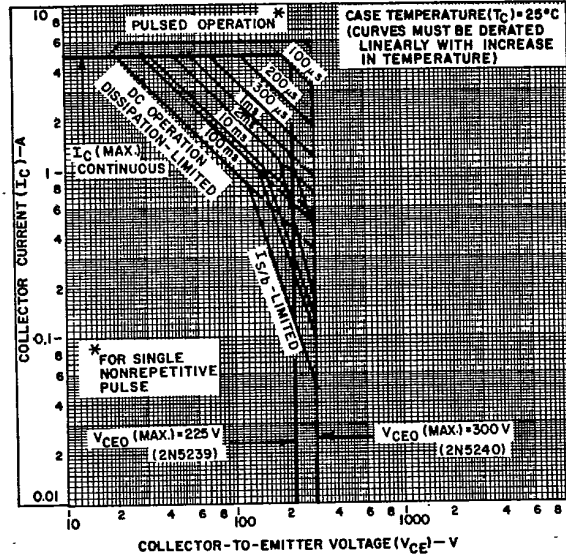

Fig. 3 - Maximum operating areas for both types.

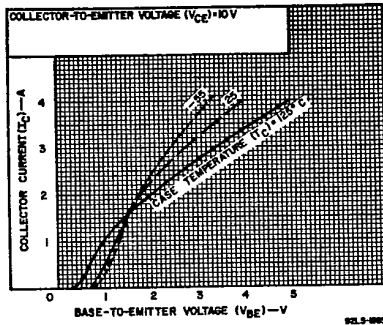

Fig. 4 - Typical transfer characteristics for both types.

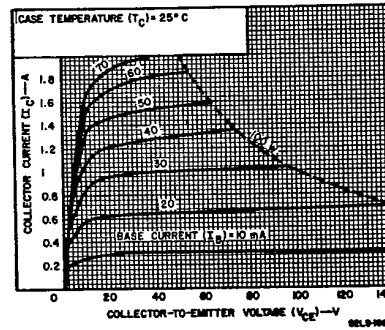

Fig. 5 - Typical output characteristics for both types.

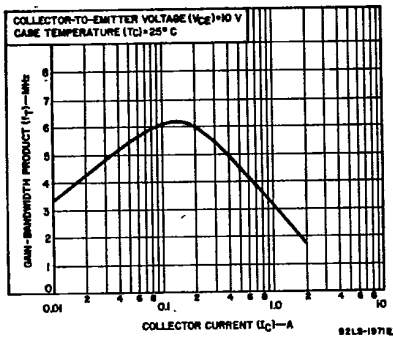

Fig. 6 - Typical gain-bandwidth product as a function of collector current for both types.

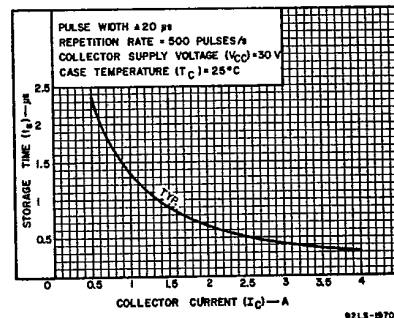

Fig. 7 - Typical saturated-switching time (storage) as a function of collector current for both types.

2N5239, 2N5240

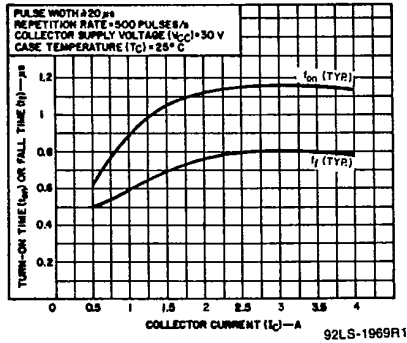

Fig. 8 — Typical saturated-time (turn-on or fall) as a function of collector current for both types.

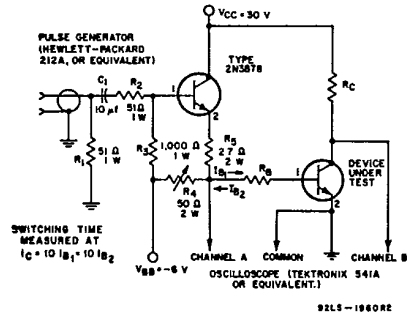

Fig. 9 — Circuit used to measure sustaining voltages,  $V_{CE0(sus)}$  and  $V_{CER(sus)}$  for both types.

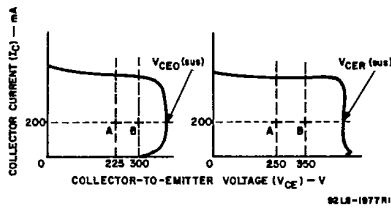

Fig. 10 — Oscilloscope display for  $V_{CE0(sus)}$  and  $V_{CER(sus)}$  measurement.

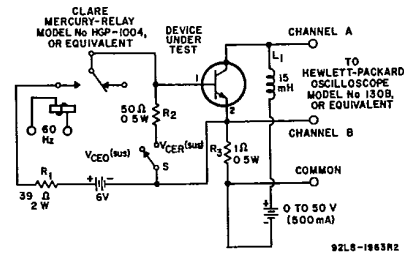

Fig. 11 — Circuit used to measure switching times for both types.

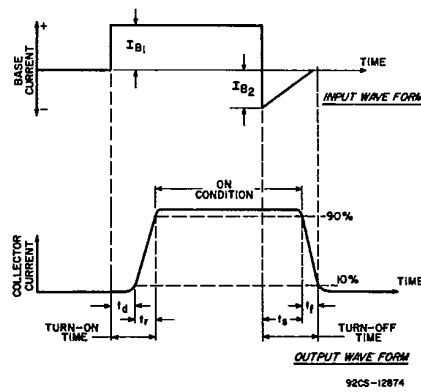

Fig. 12 — Phase relationship between input and output currents showing reference points for specification of switching times.