

Product Features

- +32 dBm IIP3
- RF 800 – 960 MHz
- IF 200 – 350 MHz
- High-side LO configuration
- +17 dBm Drive Level
- Low Cost SOIC-8 Package
- No External Bias Required

Applications

- Mobile Infrastructure

Product Description

The MH203 is a passive GaAs MESFET mixer that provides high dynamic range performance in a low cost SOIC-8 package. WJ's MH203 uses patented techniques to realize +32 dBm Input IP3 at an LO drive level of +17 dBm when used in a simple application circuit as an upconverting or downconverting high-side LO configuration. This single monolithic integrated circuit does not require any external baluns or bias elements.

Typical applications include frequency up/down conversion, modulation and demodulation for receivers and transmitters used in 2.5G and 3G systems using the cellular and GSM frequency bands.

Functional Diagram

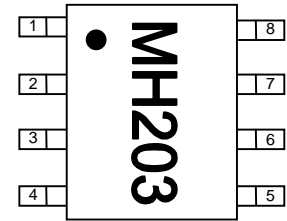

Function	Pin No.
LO	2
IF & RF*	7
GND	1, 3, 4, 5, 6, 8

* External components (inductors & capacitors) are required to diplex the signal

Specifications¹

Parameters	Units	Min	Typ	Max	Comments
RF Frequency Range	MHz	800		960	
LO Frequency Range	MHz	1000		1310	
IF Frequency Range	MHz	200		350	
SSB Conversion Loss	dB		8.2	9.5	
Noise Figure	dB		9.0		See note 2
Input IP3	dBm	+28	+32		See note 3
Input P1dB	dBm		+16		
LO – RF Isolation	dB	25	30		
LO – IF Isolation	dB	50	65		
RF – IF Isolation	dB		25		
Return Loss: RF Port	dB		-20		See note 4
Return Loss: IF Port	dB		-17		See note 4
Return Loss: LO Port	dB		-12		
LO Drive Level	dBm		+17		

Test conditions unless otherwise noted:

1. Performance is with the use of an application specific circuit (shown on page 4) with a high-side LO at +17 dBm in a downconverting application at 25° C.
2. Assumes LO injection noise is filtered at the thermal noise floor, -174 dBm/Hz, at the RF, IF, and Image frequencies.
3. IIP3 is measured with $\Delta f = 1$ MHz with $RF_{in} = 0$ dBm / tone.
4. The return loss is measured after the diplexer which splits the RF and IF signals from the mixer. Details of the diplexing circuit is shown on page 4.

Absolute Maximum Rating

Parameter	Rating
Operating Case Temperature	-40° to +85 °C
Storage Temperature	-65° to +100 °C
Maximum Input LO Power ⁶	+21 dBm

5. Operation of this device above any of these parameters may cause permanent damage.
6. Total sum of the LO and RF port power should not exceed +23 dBm.

Ordering Information

Part No.	Description
MH203	Cellular-band MMIC Mixer
MH203-PCB	Fully-Assembled Mixer Application Board

Specifications and information are subject to change without notice



Typical Performance Plots: High-side Downconversion

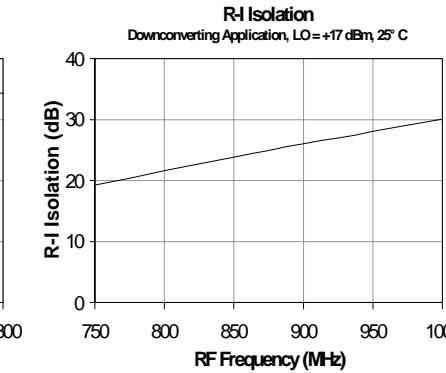
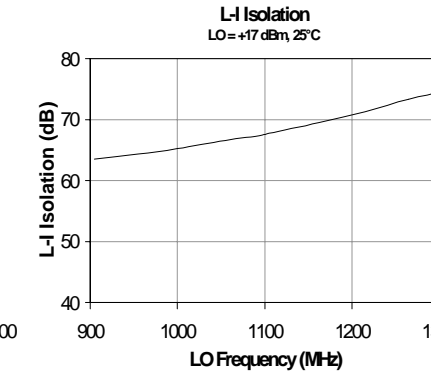
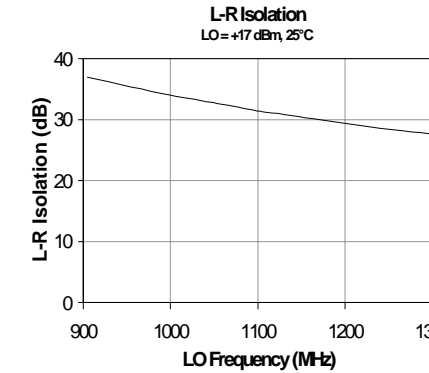
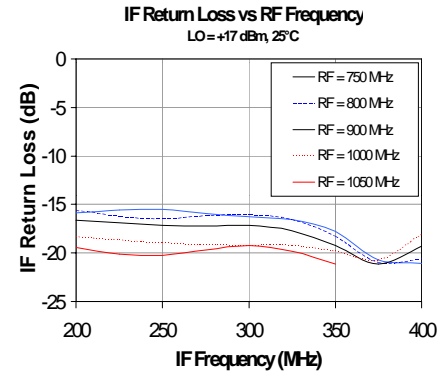
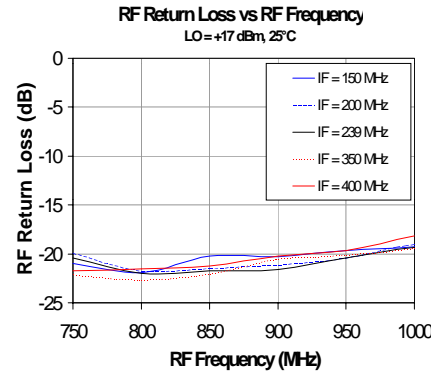
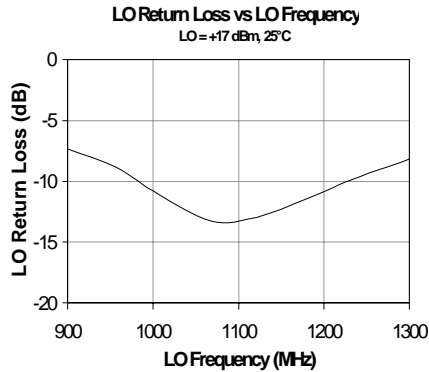
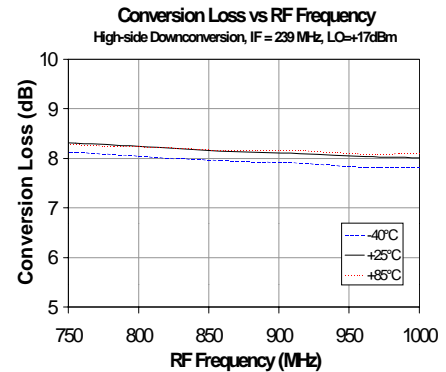
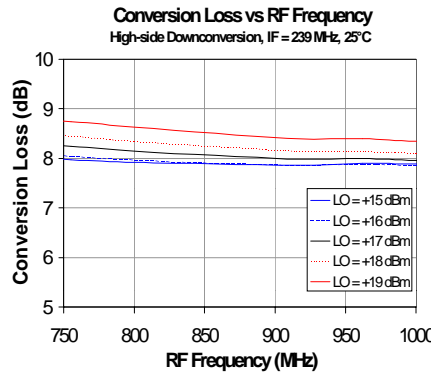
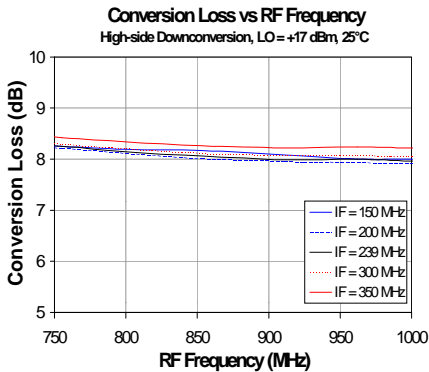
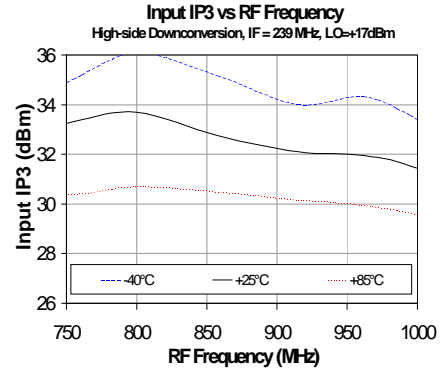
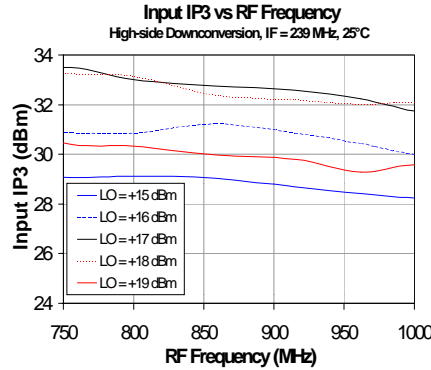
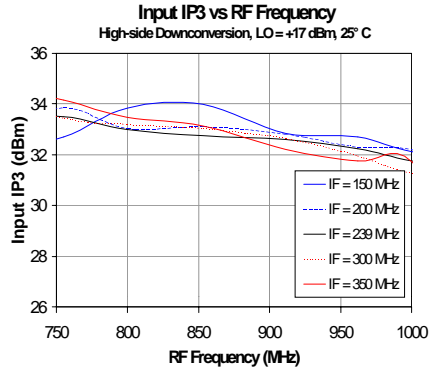



Typical Performance Plots: High-side Upconversion

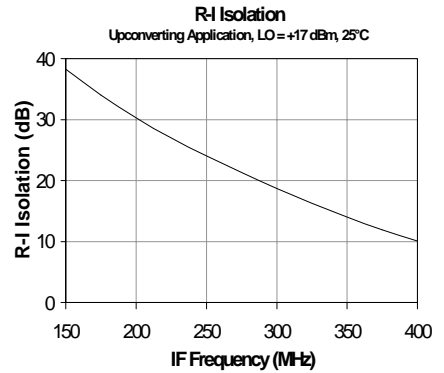
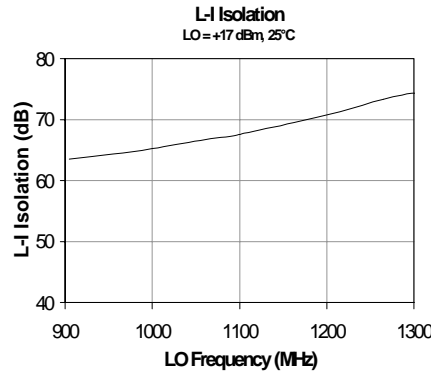
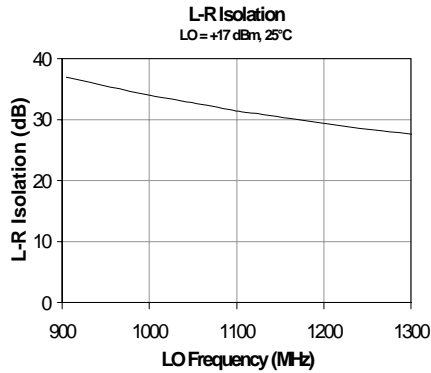
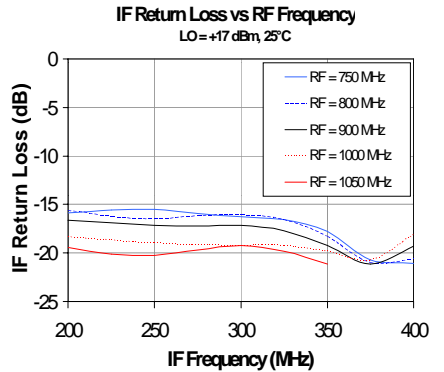
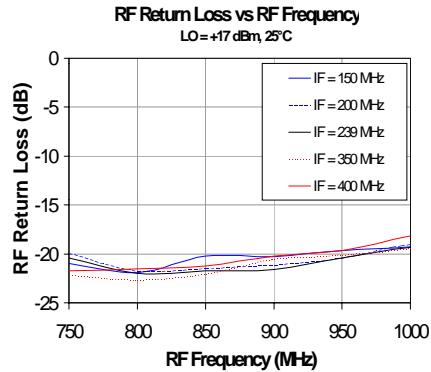
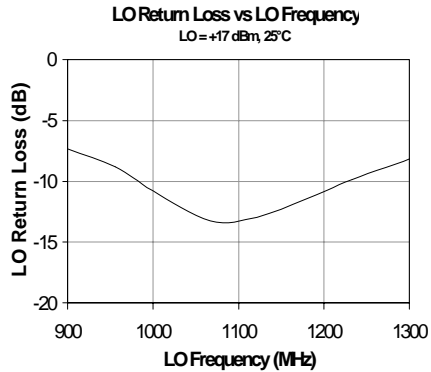
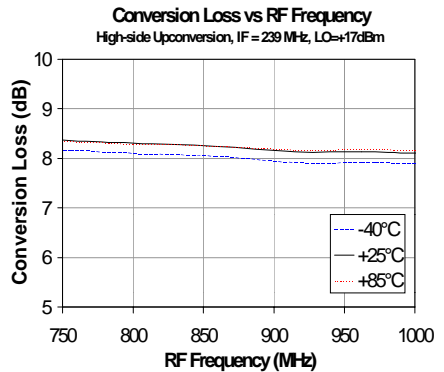
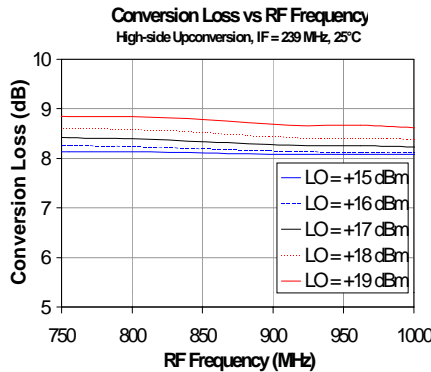
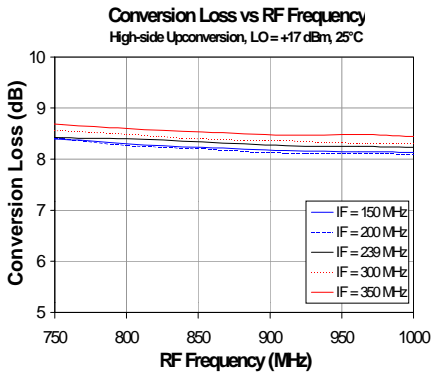
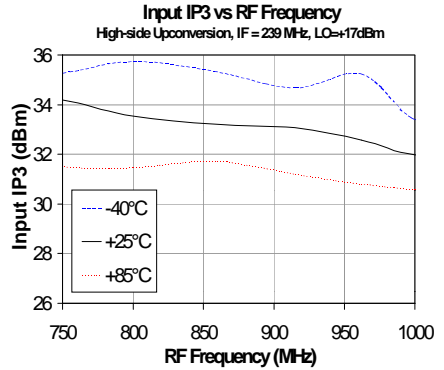
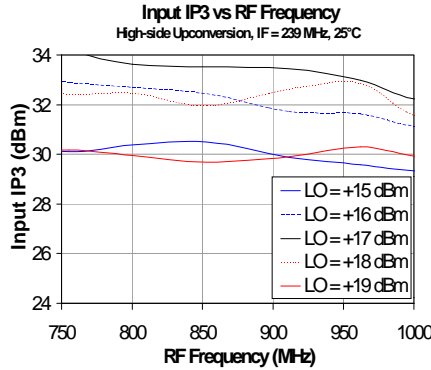
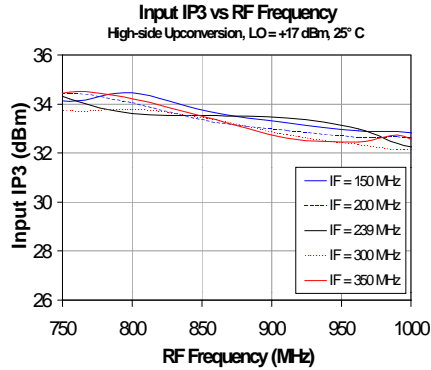



MH203

High Linearity Cellular-Band MMIC Mixer

The Communications Edge™

Product Information

Application Circuit (MH203-PCB)

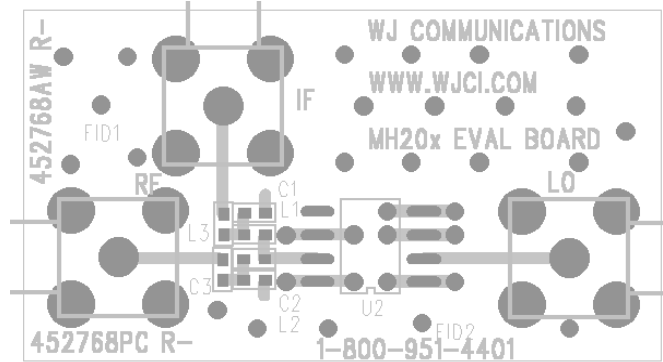
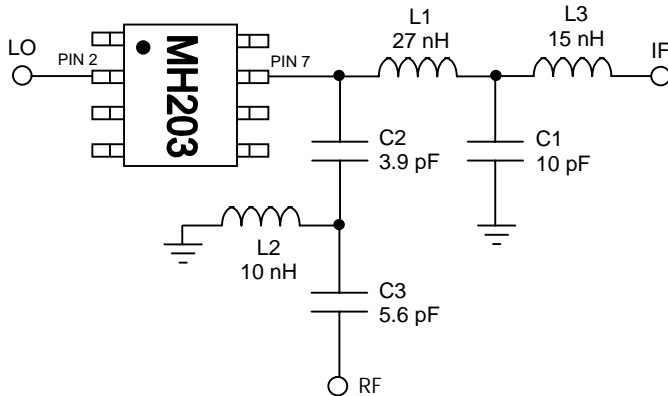

Circuit Board Material: .014" FR-4, 4 layers, .062" total thickness

All components are of size 0402.
All other pins on mixer are grounded.

Outline Drawing

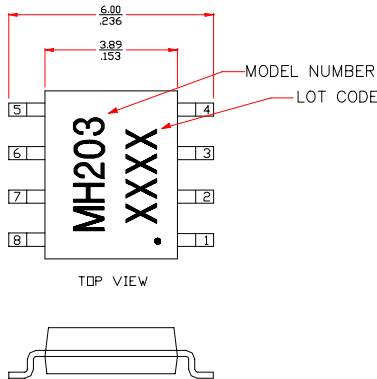

mm
inch

Product Marking

The component will be marked with an "MH203" designator followed by a four- or five-digit alphanumeric lot code on the top surface of the package. Tape and reel specifications for this part is located on the website in the "Application Notes" section.

ESD / MSL Information



Caution! ESD sensitive device.

ESD Classification: Class 1B
 Value: Passes ≥ 500 V to <1000 V
 Test: Human Body Model (HBM)
 Standard: JEDEC Standard JESD22-A114

ESD Classification: Class III
 Value: Passes ≥ 500 V to <1000 V
 Test: Charged Device Model (CDM)
 Standard: JEDEC Standard JESD22-C101

MSL Rating: Level 3 at $+235$ °C convection reflow
 Standard: JEDEC Standard J-STD-020B

Mounting Configuration / Land Pattern

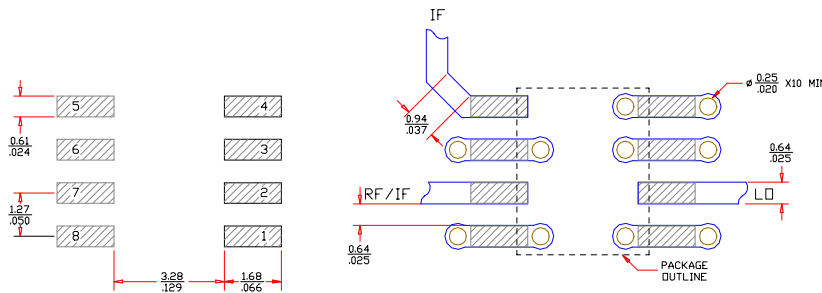

- Notes: 1. Ground vias are critical for thermal and RF grounding considerations.
 2. A minimum of 10 ground vias are required for 14 mil and 28 mil FR4 board.
 3. If your PCB design rules allow, ground vias should be placed under the land pattern for better RF and thermal performance. Otherwise ground vias should be placed as close to land pattern as possible.
 4. Trace width depends on PC board.

Functional Pin Layout

Pin	Function
1	Ground
2	LO Port
3	Ground
4	Ground
5	Ground
6	Ground
7	RF / IF Port*
8	Ground

* External components (inductors & capacitors) are required to diplex the signal

Specifications and information are subject to change without notice