



DOCUMENT NUMBER AND REVISION  
**VL-FS-MGLS12864T-54 REV. A**  
**(MGLS12864T-BLUE-LED WHITE)**

DOCUMENT TITLE:  
**SPECIFICATION**  
**OF**  
**LCD MODULE TYPE**

CUSTOMER	
MODEL NUMBER	<b>MGLS12864T-54</b>
CUSTOMER APPROVAL	
DATE	

DEPARTMENT	NAME	SIGNATURE	DATE
PREPARED BY	PHILIP CHENG		2002/10/29
CHECKED BY	TOM LEE		2002/10/29
APPROVED BY	CYRUS CHEUNG		2002/10/29

DISTRIBUTION LIST: MARKETING



**DOCUMENT REVISION HISTORY 1:**

DOCUMENT REVISION FROM TO	DATE	DESCRIPTION	CHANGED BY	CHECKED BY
A	2002.10.29	Based on document VL-TS-MGLS12864T-XX REV. G, 2002.10.07).	PHILIP CHENG	TOM LEE



## CONTENTS

	<u>Page No.</u>
1. GENERAL DESCRIPTION	4
2. MECHANICAL SPECIFICATIONS	4
3. INTERFACE SIGNALS	6
4. ABSOLUTE MAXIMUM RATINGS	7
4.1 ELECTRICAL MAXIMUM RATINGS (Ta=25°C)	7
4.2 ENVIRONMENTAL CONDITION	7
5. ELECTRICAL SPECIFICATIONS	8
5.1 TYPICAL ELECTRICAL CHARACTERISTICS	8
5.2 TIMING SPECIFICATIONS	9
5.3 TIMING DIAGRAM OF VDD AGAINST V0	10
6. APPENDIX	11

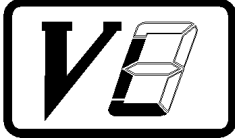

---

## VARITRONIX LIMITED

---

### Specification of LCD Module Type Item No.: MGLS12864T-54

#### 1. General Description

- 128 x 64 dots STN Negative Blue Transmissive LCD graphic module.
- Driving scheme: 1:64 multiplexed drive, 1/9 bias.
- Viewing direction: 6 O'clock.
- 'TOSHIBA' T6963C flat pack or equivalent LCD controller.
- 'TOSHIBA' T6A39 flat pack or equivalent LCD segment drivers.
- 'TOSHIBA' T6A40 flat pack or equivalent LCD common driver.
- 8K byte display SRAM.
- White LED05 backlight.

#### 2. Mechanical Specifications

The mechanical detail is shown in Fig. 1 and summarized in Table 1 below.

Table 1

Parameter	Specifications	Unit
Outline dimensions	78.0(W) x 70.0(H) x 13.0 MAX.(D) (Excluded cable) 82.0(W) x 70.0(H) x 13.0 MAX.(D) (Included cable)	mm
Viewing area	62.0(W) x 44.0(H)	mm
Active area	56.27(W) x 38.35(H)	mm
Display format	128(Horizontal) x 64(Vertical)	dots
Dot size	0.39(W) x 0.55(H)	mm
Dot spacing	0.05(W) x 0.05(H)	mm
Dot pitch	0.44(W) x 0.60(H)	mm
Weight	TBD	gram





### 3. Interface signals

Table 2

Pin No.	Symbol	Description
1	FG	Frame ground (see note 1)
2	VSS	Ground (0V)
3	VDD	Power supply for logic (+5V)
4	V0	Power supply for LCD drive
5	/WR	Command/Data write to module when "Low"
6	/RD	Command/Data read from module when "Low"
7	/CE	Chip enable of controller when "Low"
8	C / $\bar{D}$	Command/Data read/write. "High" for command read/write and "Low" for data read/write
9	/RST	Controller reset when "Low"
10	DB0	Data input/output (LSB)
11	DB1	Data input/output
12	DB2	Data input/output
13	DB3	Data input/output
14	DB4	Data input/output
15	DB5	Data input/output
16	DB6	Data input/output
17	DB7	Data input/output (MSB)
18	FS	Font select. "High" for 6 x 8 font & "Low" for 8 x 8 font.
-	K	Cathode of backlight
-	A	Anode of backlight

Note 1: This pin is electrically connected to the metal bezel(frame).  
User can choose to connect this pin to VSS or leave it open.



#### 4. Absolute Maximum Ratings

##### 4.1 Electrical Maximum Ratings(Ta = 25 °C)

Table 3

Parameter	Symbol	Min.	Max.	Unit
Supply voltage (Logic & LCD)	VDD - VSS	-0.3	+7.0	V
Supply voltage (LCD drive)	VLCD=VDD - V0	-0.3	+28.0	V
Input voltage	Vin	-0.3	VDD +3.0	V

Note:

The modules may be destroyed if they are used beyond the absolute maximum ratings.  
All voltage values are referenced to VSS = 0V.

##### 4.2 Environmental Condition

Table 4

Item	Operating Temperature (Topr)		Storage Temperature (Tstg)		Remark
	Min.	Max.	Min.	Max.	
Ambient Temperature	0°C	+50°C	-10°C	+60°C	Dry
Humidity	95% max. RH for Ta ≤ 40°C < 95% RH for Ta > 40°C				no condensation
Vibration (IEC 68-2-6) cells must be mounted on a suitable connector	Frequency: 10 ~ 55 Hz Amplitude: 0.75 mm Duration: 20 cycles in each direction.				3 directions
Shock (IEC 68-2-27) Half-sine pulse shape	Pulse duration : 11 ms Peak acceleration: 981 m/s <sup>2</sup> = 100g Number of shocks : 3 shocks in 3 mutually perpendicular axes.				3 directions



## 5. Electrical Specifications

### 5.1 Typical Electrical Characteristics

At Ta = 25 °C, VDD = 5V±5%, VSS = 0V.

Table 5

Parameter	Symbol	Conditions	Min.	Typ.	Max.	Unit
Supply voltage (Logic)	VDD –VSS		4.75	5.00	5.25	V
Supply voltage (LCD)	VLCD =VDD –V0	VDD = 5V,Note 1	11.5	12.0	12.5	V
Input signal voltage	VIN	“H” level	VDD -2.2	-	VDD	V
		“L” level	0	-	0.8	V
Supply current (Logic & LCD)	IDD	Character mode, VDD = 5V,Note 1	-	6.1	9.2	mA
		Checker board mode, VDD = 5V, Note 1	-	6.2	9.3	mA
Supply current (LCD)	I0	Character mode, VDD = 5V,Note 1	-	2.2	3.3	mA
		Checker board mode, VDD = 5V, Note 1	-	2.2	3.3	mA
Supply voltage of white LED05 backlight	VLED	Forward current =40 mA  Number of LED dies =(1x1)x2 =1x2 =2.  Color rank: B	3.1	3.4	3.6	V

Note 1: There is tolerance in optimum LCD driving voltage during production and it will be within the specified range.





## 5.2 Timing Specifications

At  $T_a = 0^\circ\text{C}$  To  $+50^\circ\text{C}$ ,  $V_{DD} = 5V \pm 5\%$ ,  $V_{SS} = 0V$

Refer to Fig. 2, the bus timing diagram.

Table 6

Parameter	Symbol	Min.	Max.	Unit
C/D Set-up time	$t_{CDS}$	100	-	ns
C/D Hold Time	$t_{CDH}$	10	-	ns
/CE, /RD, /WR Pulse Width	$t_{CE}, t_{RD}, t_{WR}$	80	-	ns
Data Set-up Time	$t_{DS}$	80	-	ns
Data Hold Time	$t_{DH}$	40	-	ns
Access Time	$t_{ACC}$	-	150	ns
Output Hold Time	$t_{OH}$	10	50	ns

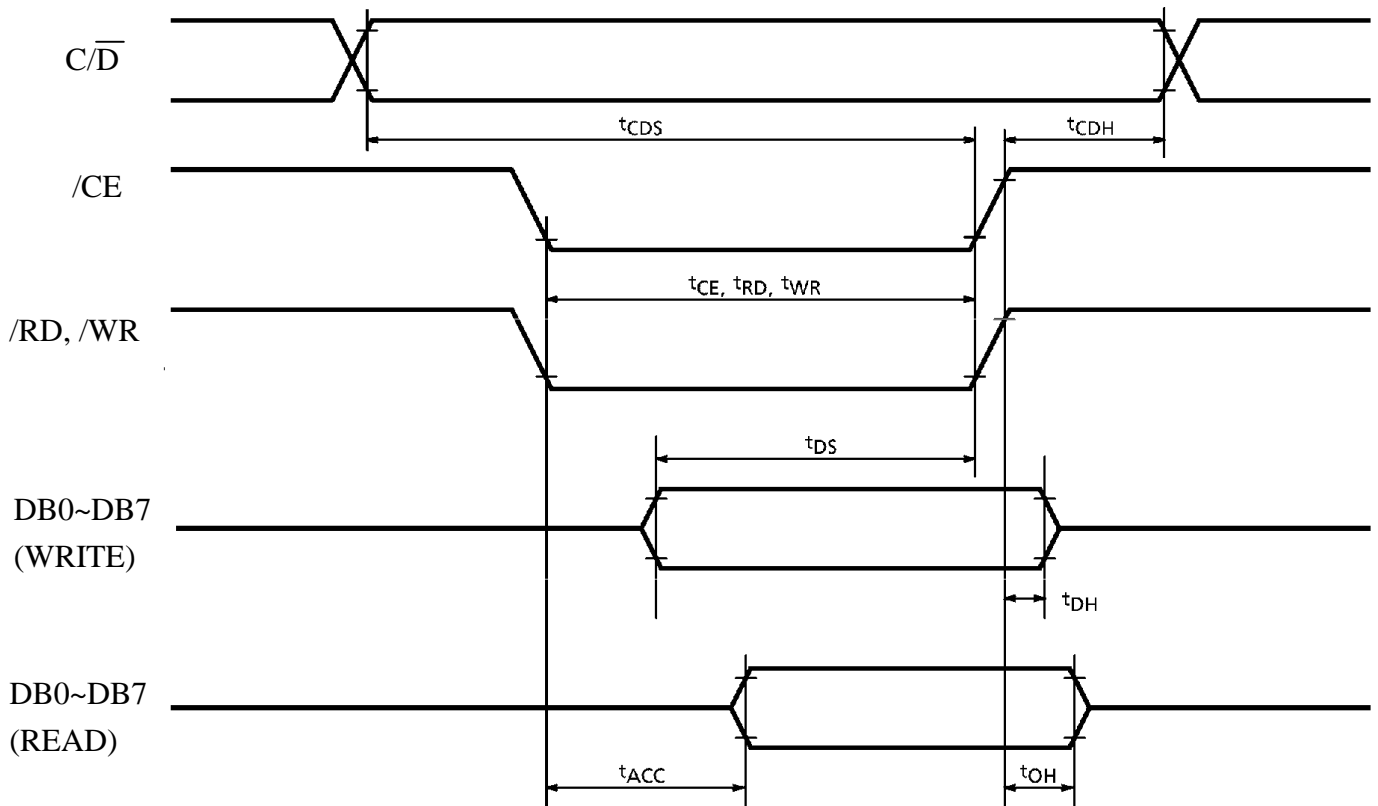

Figure 2: Bus Timing Diagram



### 5.3 Timing Diagram of VDD Against V0.

Power on sequence shall meet the requirement of Figure 3, the timing diagram of VDD against V0.

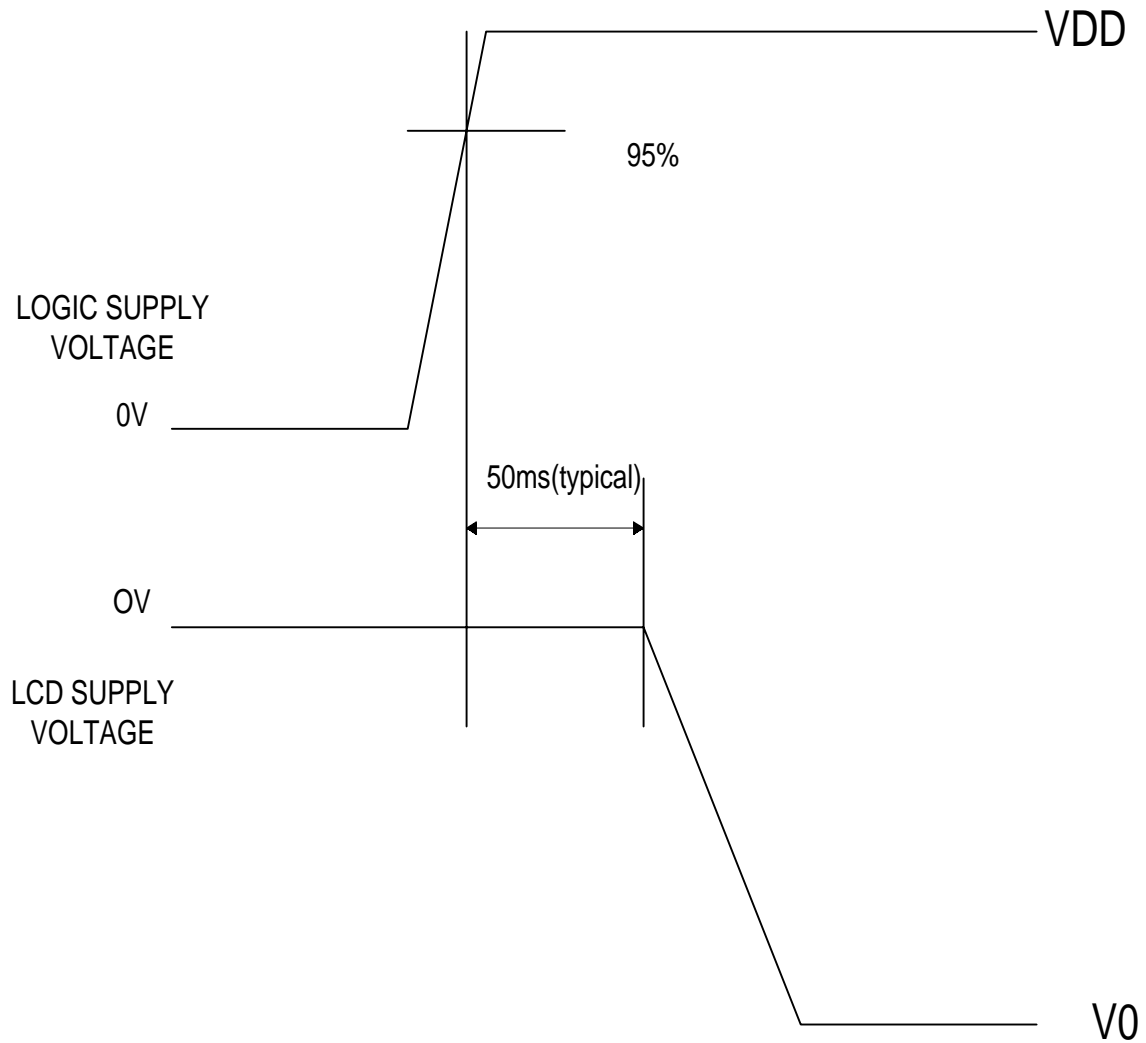

Figure 3: Timing Diagram of VDD Against V0.



## 6. APPENDIX

These specifications shall be applied to the White LED-Lamp (LED or LEDs),  
NSPWF50BS, which is supplied by Nichia Corporation (Nichia).

### 1. SPECIFICATIONS

#### (1) Absolute Maximum Rating

(Ta=25°C)

Item	Symbol	Absolute Maximum Rating	Unit
Forward Current	IF	30	mA
Pulse Forward Current	IFP	100	mA
Reverse Voltage	VR	5	V
Power Dissipation	PD	120	mW
Operating Temperature	Topr	-30 ~ +85	°C
Storage Temperature	Tstg	-40 ~ +100	°C
Lead Soldering Temperature	Tsol	260±5°C for 5sec. (3.0mm from the base of the epoxy bulb)	

IFP Conditions : Pulse Width ≤ 10msec. and Duty ≤ 1/10

#### (2) Initial Electrical/Optical Characteristics

(Ta=25°C)

Item	Symbol	Condition	Min.	Typ.	Max.	Unit	
Forward Voltage	VF	IF=20[mA]	—	3.6	4.0	V	
Reverse Current	IR	VR= 5[V]	—	—	50	μA	
Luminous Intensity	Rank S	Iv	IF=20[mA]	300	360	420	mcd
	Rank R	Iv	IF=20[mA]	210	260	300	mcd
	Rank Q	Iv	IF=20[mA]	150	180	210	mcd

※ One delivery will include three different ranks of products. The quantity-ratio of the three ranks is decided by Nichia.

Measurement Uncertainty of the Luminous Intensity : ±10%

#### Color Ranks

(IF=20mA, Ta=25°C)

Rank a	
x	0.250 0.250 0.290 0.290
y	0.205 0.250 0.305 0.260

Rank b	
x	0.290 0.290 0.330 0.330
y	0.260 0.305 0.365 0.320

Rank c	
x	0.330 0.330 0.370 0.370
y	0.320 0.365 0.420 0.375

※ One delivery will include the consecutive two ranks of products.

The quantity-ratio of the two ranks is decided by Nichia.

Measurement Uncertainty of the Color Coordinates : ±0.02

### 2. TYPICAL INITIAL OPTICAL/ELECTRICAL CHARACTERISTICS

Please refer to figures No.STLZ-A906042, No.STLZ-A801473.



ICI Chromaticity Diagram

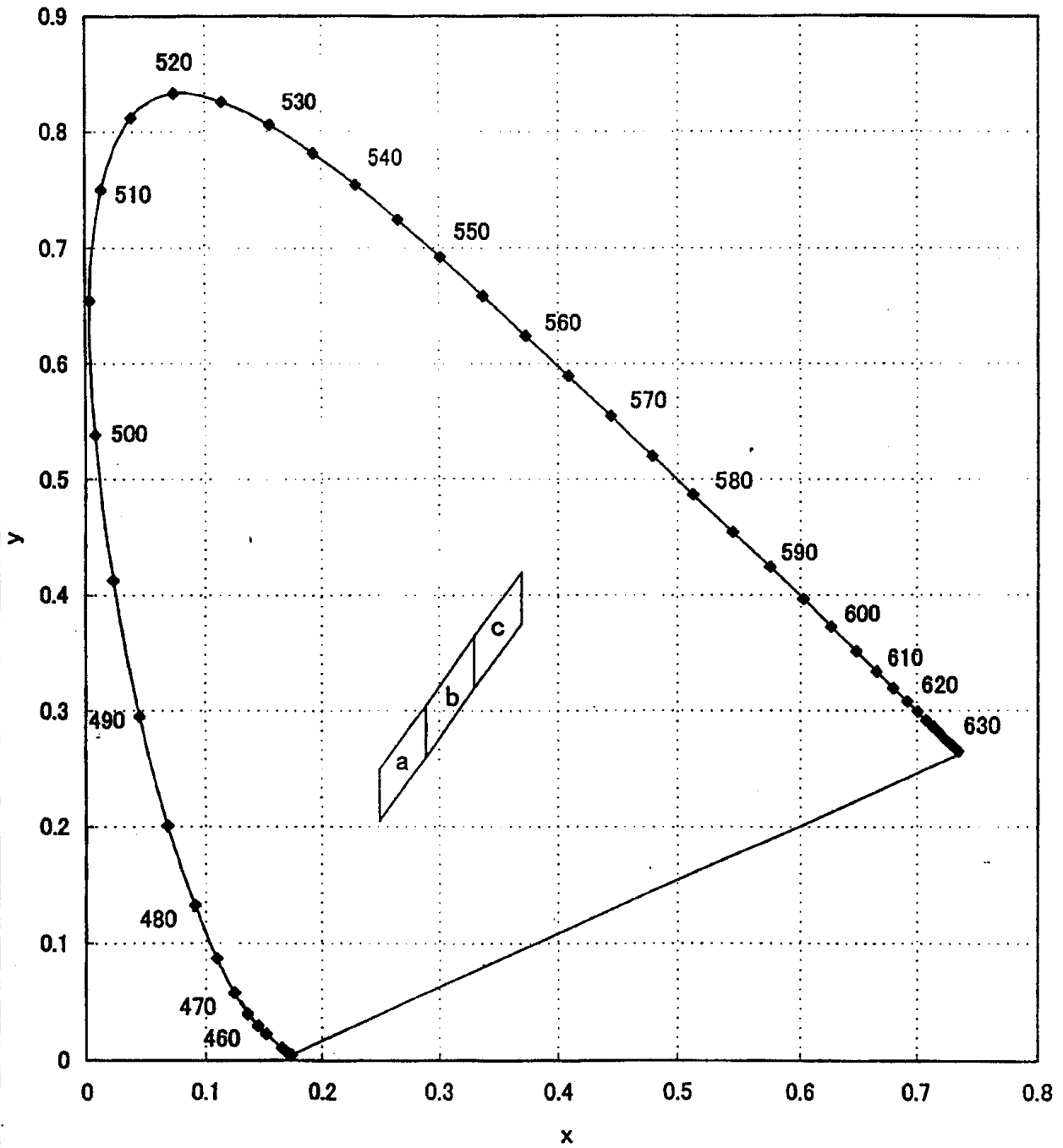

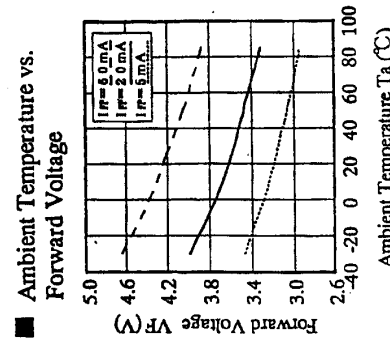
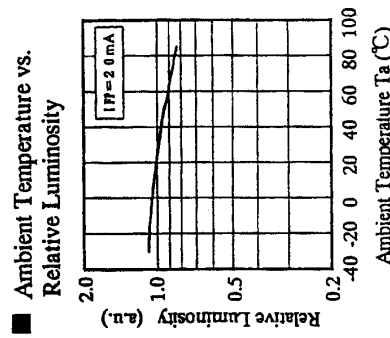
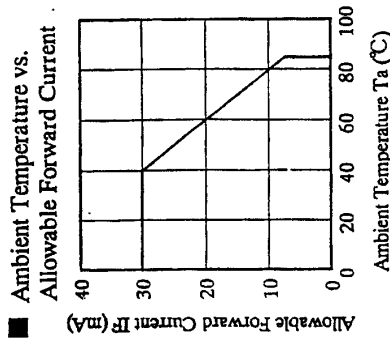
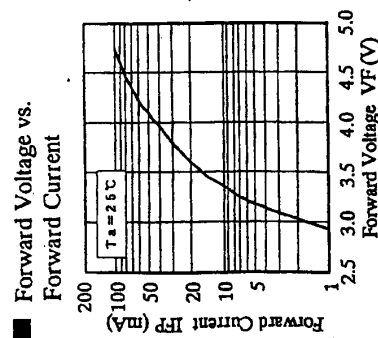
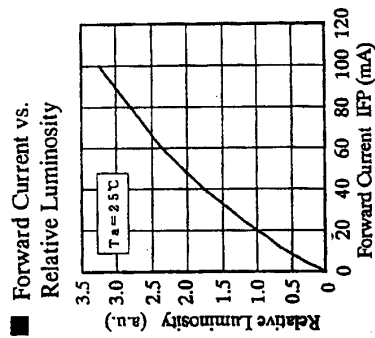
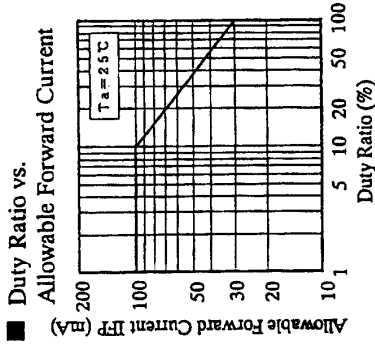

Rev.1	Section	Approve	Check	Draw
Rev.2	ST	Bando	Yamashita	Tamura
Rev.3	Date	Jun.1,1999		
Rev.4	Model	NSPWxxxx		
<b>NICHIA CORPORATION</b> Title TYP.CHARACTERISTICS No. STLZ-A906042				



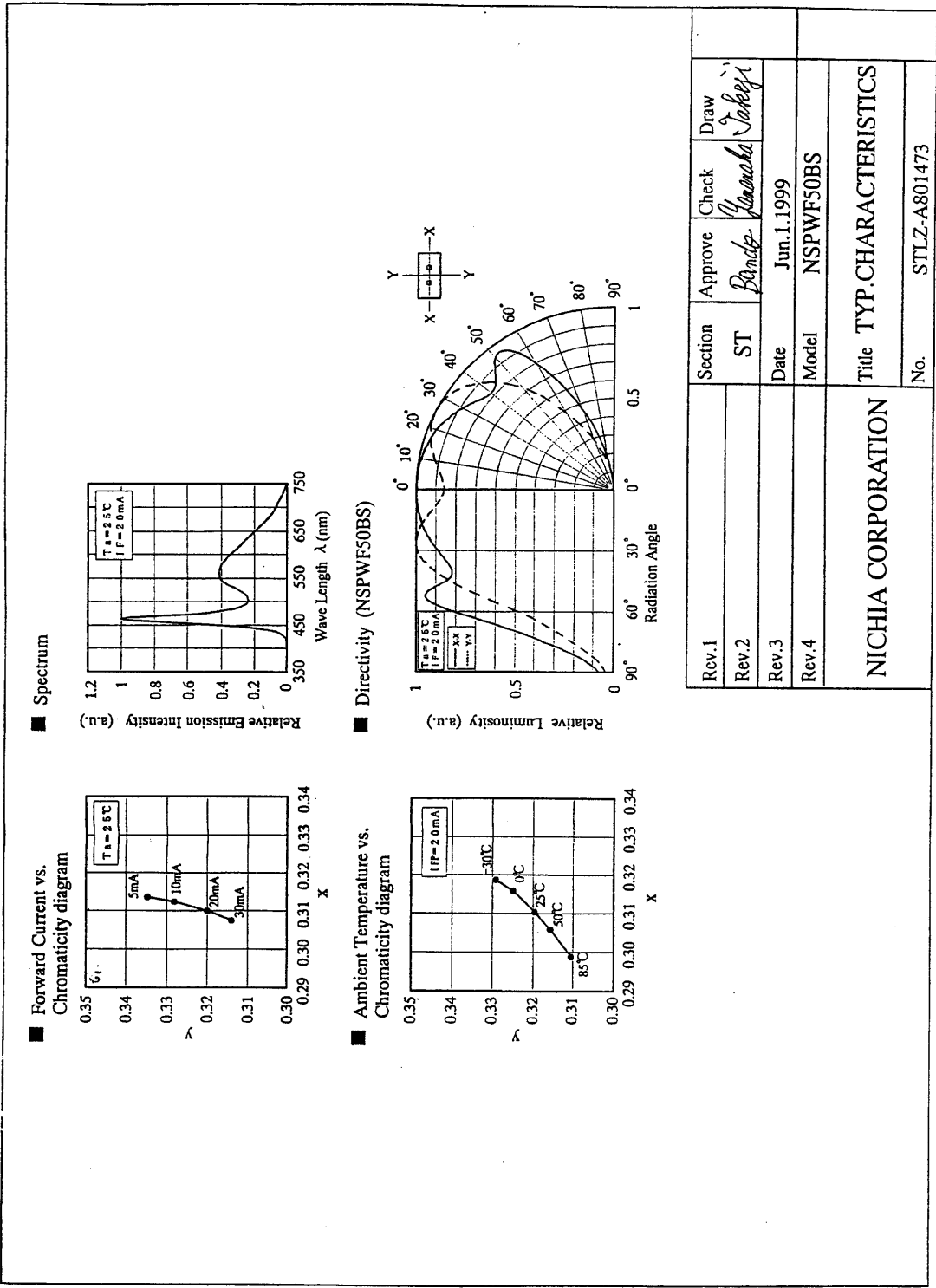

“Varitronix Limited reserves the right to change this specification.”

FAX:(852) 2343-9555.

URL:<http://www.varitronix.com>