

# HMHAA280, HMHA2801 Series, HMHA281 Half Pitch Mini-Flat Package 4-Pin Optocouplers

## Features

- Compact 4-pin package (2.4mm maximum standoff height)
- Half pitch leads for optimum board space savings
- Current Transfer Ratio in selected groups
 

HMHA2801: 80–600%	HMHA2801A: 80–160%
HMHA2801B: 50–150%	HMHA2801C: 50–100%
HMHA281: 50–600%	HMHAA280: 50–600%
- Available in tape and reel quantities of 500 and 2500
- Applicable to Infrared Ray reflow (230°C Max, 30 seconds)
- BSI (File #8611/8612), CSA (File #1201524), UL (File #E90700) and VDE (File #136480) certified

## Description

The HMHA281, HMHA2801 Series consists of a gallium arsenide infrared emitting diode driving a silicon phototransistor in a compact 4-pin mini-flat package. The lead pitch is 1.27mm.

The HMHAA280 series consists of two gallium arsenide infrared emitting diodes, connected in inverse parallel, driving a single silicon phototransistor in a compact 4-pin mini-flat package. The lead pitch is 1.27mm.

## Applications

### HMHAA280

- AC line monitor
- Unknown polarity DC sensor
- Telephone line receiver

### HMHA281, HMHA2801 Series

- Digital logic inputs
- Microprocessor inputs
- Power supply monitor
- Twisted pair line receiver
- Telephone line receiver

## Package Dimensions

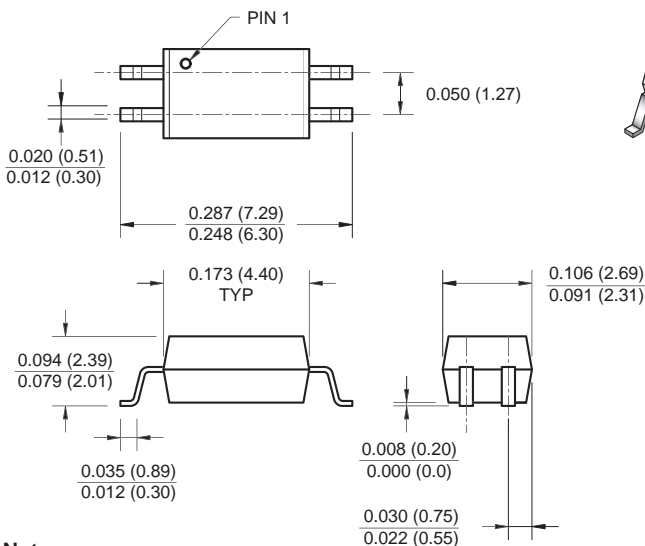

**Note:**

All dimensions are in inches (millimeters)

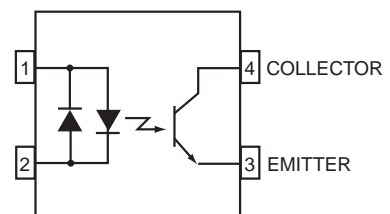
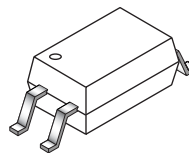

Equivalent Circuit  
(HMHAA280)

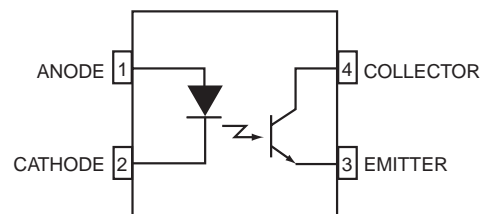

Equivalent Circuit  
(HMHA281, HMHA2801)

**Absolute Maximum Ratings** ( $T_A = 25^\circ\text{C}$  unless otherwise specified)

Symbol	Parameter	Value	Units
<b>TOTAL PACKAGE</b>			
$T_{\text{STG}}$	Storage Temperature	-55 to +125	$^\circ\text{C}$
$T_{\text{OPR}}$	Operating Temperature	-55 to +100	$^\circ\text{C}$
<b>EMITTER</b>			
$I_{\text{F (avg)}}$	Continuous Forward Current	50	mA
$I_{\text{F (pk)}}$	Peak Forward Current (1 $\mu\text{s}$ pulse, 300pps.)	1	A
$V_{\text{R}}$	Reverse Input Voltage (HMHA)	6	V
$P_{\text{D}}$	Power Dissipation	60	mW
	Derate linearly (above $25^\circ\text{C}$ )	0.6	mW/ $^\circ\text{C}$
<b>DETECTOR</b>			
	Continuous Collector Current	50	mA
$P_{\text{D}}$	Power Dissipation	150	mW
	Derate linearly (above $25^\circ\text{C}$ )	1.5	mW/ $^\circ\text{C}$
$V_{\text{CEO}}$	Collector-Emitter Voltage	80	V
$V_{\text{ECO}}$	Emitter-Collector Voltage	7	V

**Electrical Characteristics** ( $T_A = 25^\circ\text{C}$ )

Symbol	Parameter	Test Conditions	Device	Min.	Typ.*	Max.	Unit
<b>INDIVIDUAL COMPONENT CHARACTERISTICS</b>							
<b>Emitter</b>							
$V_{\text{F}}$	Forward Voltage	$I_{\text{F}} = 10\text{mA}$	HMHA281	1.0		1.3	V
			HMHA2801				
			HMHA2801A	1.0		1.3	
			HMHA2801B				
		$I_{\text{F}} = 20\text{mA}$	HMHA2801C			1.4	
$I_{\text{F}} = \pm 5\text{mA}$	HMHAA280			1.4			
$I_{\text{R}}$	Reverse Current	$V_{\text{R}} = 5\text{V}$	All			5	$\mu\text{A}$
<b>Detector</b>							
$BV_{\text{CEO}}$	Breakdown Voltage Collector to Emitter	$I_{\text{C}} = 0.5\text{mA}$ , $I_{\text{F}} = 0$	All	80			V
$BV_{\text{ECO}}$	Emitter to Collector	$I_{\text{E}} = 100\mu\text{A}$ , $I_{\text{F}} = 0$	All	7			
$I_{\text{CEO}}$	Collector Dark Current	$V_{\text{CE}} = 80\text{V}$ , $I_{\text{F}} = 0$	All			100	nA
$C_{\text{CE}}$	Capacitance	$V_{\text{CE}} = 0\text{V}$ , $f = 1\text{MHz}$	All		10		pF

**Electrical Characteristics** ( $T_A = 25^\circ\text{C}$ ) (Continued)

Symbol	Characteristic	Test Conditions	Device	Min.	Typ.*	Max.	Unit
<b>TRANSFER CHARACTERISTICS</b>							
CTR	DC Current Transfer Ratio	$I_F = \pm 5\text{mA}, V_{CE} = 5\text{V}$	HMHAA280	50		600	%
		$I_F = 5\text{mA}, V_{CE} = 5\text{V}$	HMHA281	50		600	
			HMHA2801	80		600	
			HMHA2801A	80		160	
			HMHA2801B	50		150	
		$I_F = 1\text{mA}, V_{CE} = 5\text{V}$	HMHA2801C	50		100	
	CTR Symmetry	$I_F = \pm 5\text{mA}, V_{CE} = 5\text{V}$	HMHAA280	0.33		3.0	
$V_{CE(SAT)}$	Saturation Voltage	$I_F = \pm 8\text{mA}, I_C = 2.4\text{mA}$	HMHAA280			0.4	V
		$I_F = 8\text{mA}, I_C = 2.4\text{mA}$	HMHA281			0.4	
			HMHA2801			0.3	
			HMHA2801A			0.3	
		$I_F = 10\text{mA}, I_C = 2\text{mA}$	HMHA2801B				
			HMHA2801C			0.2	
$t_r$	Rise Time (Non-Saturated)	$I_C = 2\text{mA}, V_{CE} = 5\text{V}, R_L = 100\Omega$	All except for HMHA2801C		3		$\mu\text{s}$
		$I_C = 2\text{mA}, V_{CE} = 2\text{V}, R_L = 1\text{K}\Omega$	HMHA2801C			9	
$t_f$	Fall Time (Non-Saturated)	$I_C = 2\text{mA}, V_{CE} = 5\text{V}, R_L = 100\Omega$	All except for HMHA2801C		3		
		$I_C = 2\text{mA}, V_{CE} = 2\text{V}, R_L = 1\text{K}\Omega$	HMHA2801C			9	
<b>ISOLATION CHARACTERISTICS</b>							
$V_{ISO}$	Steady State Isolation Voltage	1 Minute	All	2500			VRMS

 \*All typicals at  $T_A = 25^\circ\text{C}$

## Typical Performance Characteristics

Fig. 1 Forward Current vs. Forward Voltage

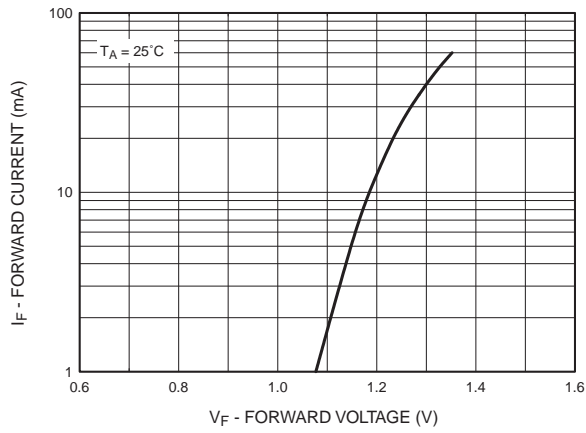

Fig. 2 Collector Current vs. Forward Current

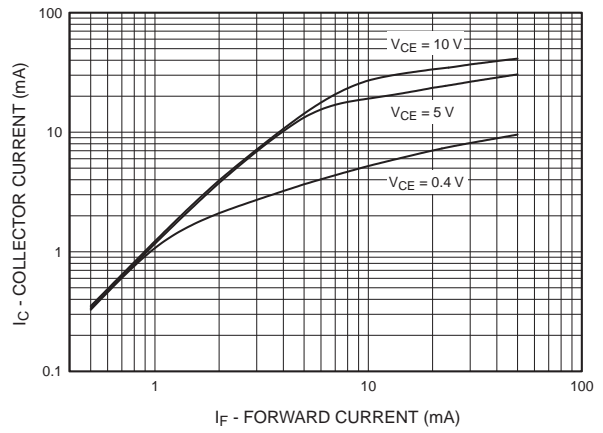

Fig. 3 Current Transfer Ratio vs. Forward Current

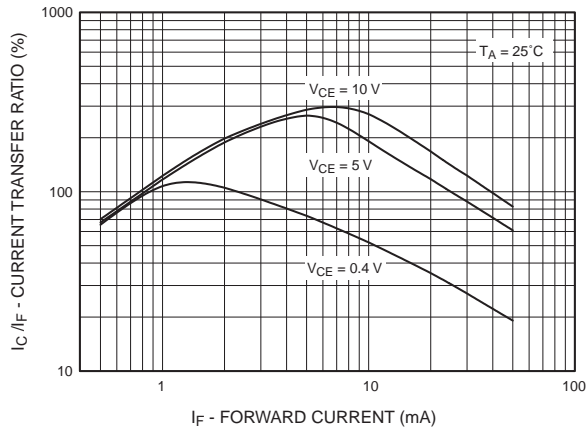

Fig. 4 Normalized CTR vs. Temperature

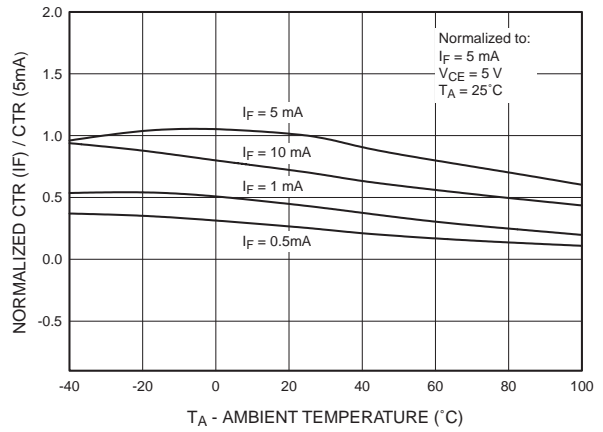
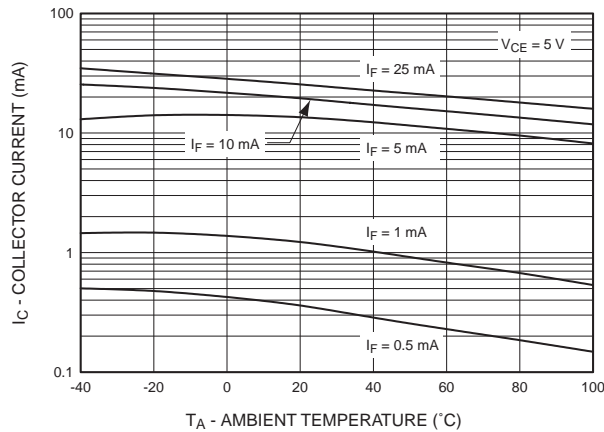

Fig. 5 Collector Current vs. Temperature



Typical Performance Characteristics (Continued)

Fig. 6 Collector Current vs. Collector-Emitter Voltage

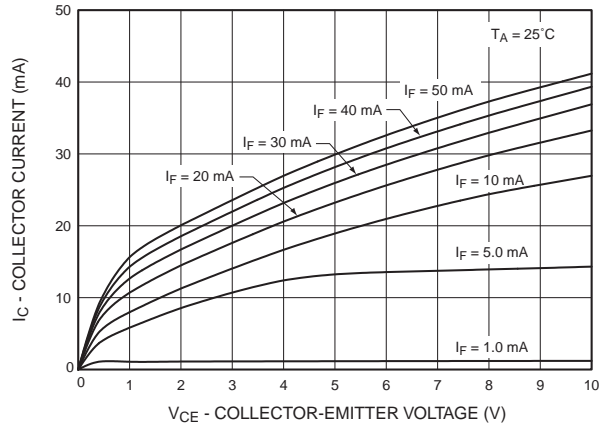

Fig. 7 Collector Current vs. Collector-Emitter Voltage

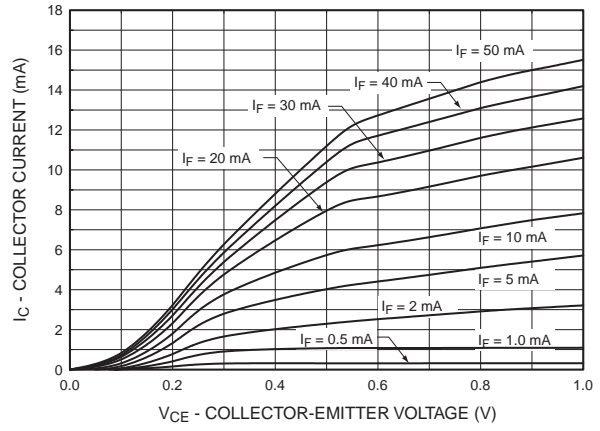

Fig. 8 Collector Dark Current vs. Temperature

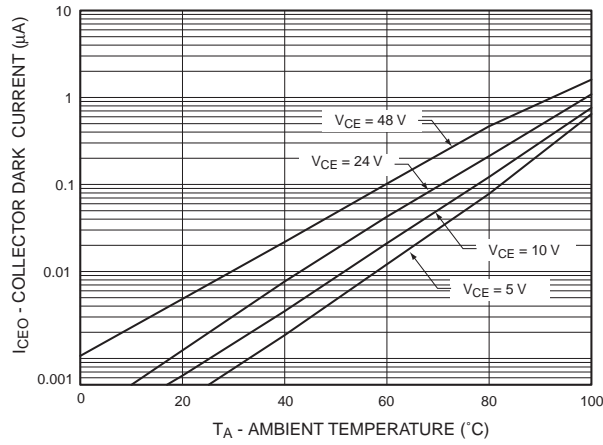

Fig. 9 Switching Time vs. Load Resistance

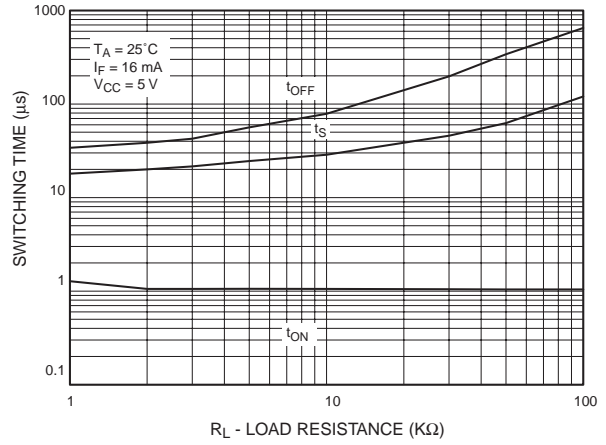
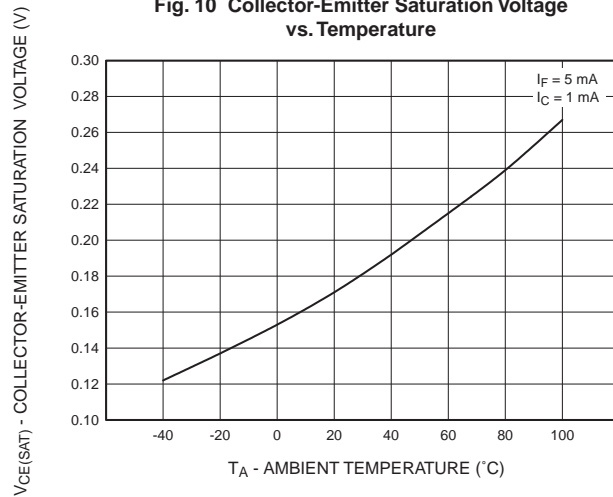

Fig. 10 Collector-Emitter Saturation Voltage vs. Temperature



### Ordering Information

Option	Description
V	VDE Approved
R1	Tape and Reel (500 units)
R2	Tape and Reel (2500 units)
R3	Tape and Reel (500 units; unit 180° rotated)
R4	Tape and Reel (2500 units; unit 180° rotated)
R1V	Tape and Reel (500 units) and VDE Approved
R2V	Tape and Reel (2500 units) and VDE Approved
R3V	Tape and Reel (500 units; unit 180° rotated) and VDE Approved
R4V	Tape and Reel (2500 units; unit 180° rotated) and VDE Approved

### Marking Information

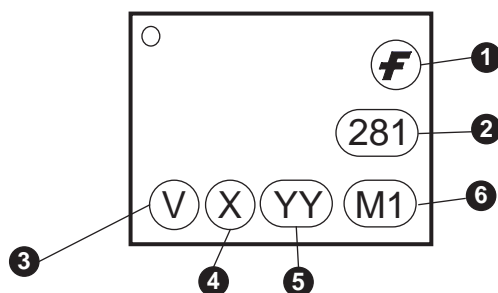

Definitions	
1	Fairchild logo
2	Device number
3	VDE mark (Note: Only appears on parts ordered with VDE option – See order entry table)
4	One digit year code
5	Two digit work week ranging from '01' to '53'
6	Assembly package code

## Tape and Reel Dimensions

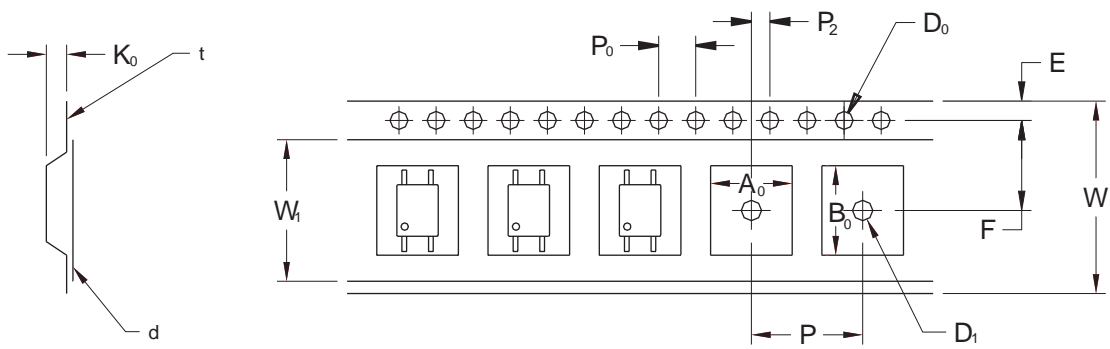

Description		Symbol	1.27 Pitch Dimensions (mm)
Tape Width		W	12.00±0.4
Tape Thickness		t	0.30±0.20
Sprocket Hole Pitch		$P_0$	4.00±0.20
Sprocket Hole Dia.		$D_0$	1.55±0.20
Sprocket Hole Location		E	1.75±0.20
Pocket Location		F	5.50±0.20
		$P_2$	2.00±0.20
Pocket Pitch		P	8.00±0.20
Pocket Dimension		$A_0$	4.40±0.20
		$B_0$	7.30±0.20
		$K_0$	2.30±0.20
Pocket Hole Dia.		$D_1$	1.55±0.20
Cover Tape Width		$W_1$	9.20
Cover Tape Thickness		d	0.065±0.02
Max. Component Rotation or Tilt			20° max
Devices Per Reel		R1	500
		R2	2500
Reel Diameter		R1	178 mm (7")
		R2	330 mm (13")

### Footprint Drawing for PCB Layout

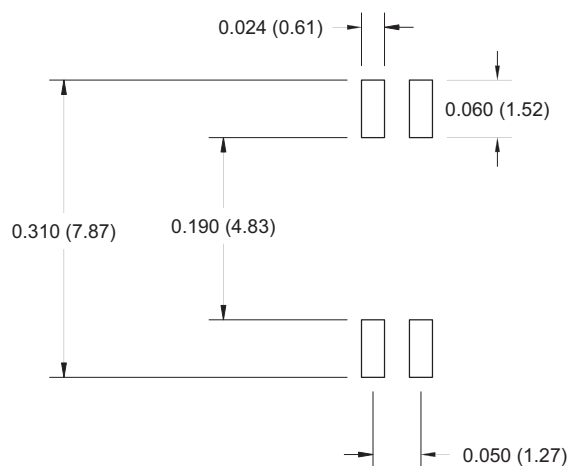

### Recommended Infrared Reflow Soldering Profile

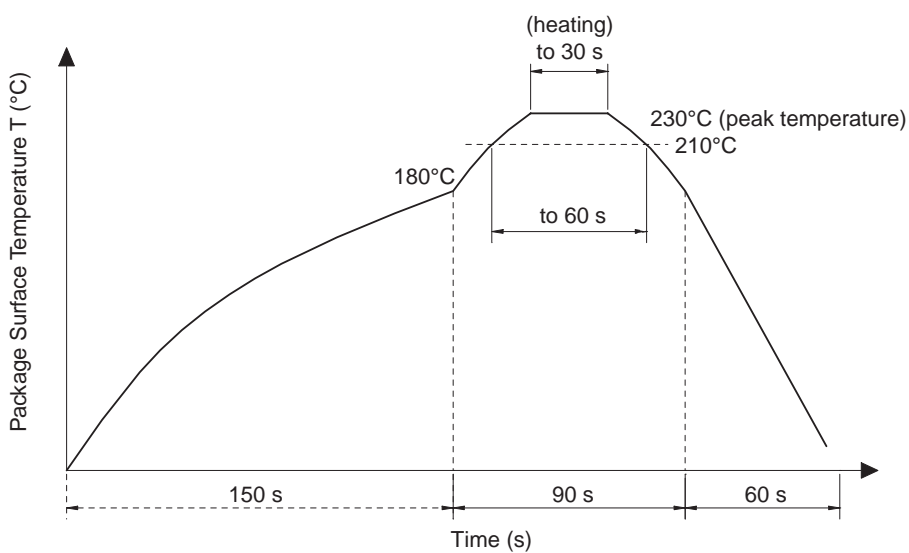

- Peak reflow temperature: 230°C (package surface temperature) for 30 seconds
- Time of temperature higher than 210°C: 60 seconds or less
- One time soldering reflow is recommended



## TRADEMARKS

The following are registered and unregistered trademarks Fairchild Semiconductor owns or is authorized to use and is not intended to be an exhaustive list of all such trademarks.

ACEx™	FAST®	ISOPLANAR™	PowerEdge™	SuperFET™
ActiveArray™	FASTr™	LittleFET™	PowerSaver™	SuperSOT™-3
Bottomless™	FPS™	MICROCOUPLER™	PowerTrench®	SuperSOT™-6
Build it Now™	FRFET™	MicroFET™	QFET®	SuperSOT™-8
CoolFET™	GlobalOptoisolator™	MicroPak™	QS™	SyncFET™
CROSSVOLT™	GTO™	MICROWIRE™	QT Optoelectronics™	TCM™
DOME™	HiSeC™	MSX™	Quiet Series™	TinyLogic®
EcoSPARK™	I <sup>2</sup> C™	MSXPro™	RapidConfigure™	TINYOPTO™
E <sup>2</sup> CMOS™	i-Lo™	OCX™	RapidConnect™	TruTranslation™
EnSigna™	ImpliedDisconnect™	OCXPro™	μSerDes™	UHC™
FACT™	IntelliMAX™	OPTOLOGIC®	ScalarPump™	UniFET™
FACT Quiet Series™		OPTOPLANAR™	SILENT SWITCHER®	UltraFET®
Across the board. Around the world.™		PACMAN™	SMART START™	VCX™
The Power Franchise®		POP™	SPM™	Wire™
Programmable Active Droop™		Power247™	Stealth™	

## DISCLAIMER

FAIRCHILD SEMICONDUCTOR RESERVES THE RIGHT TO MAKE CHANGES WITHOUT FURTHER NOTICE TO ANY PRODUCTS HEREIN TO IMPROVE RELIABILITY, FUNCTION OR DESIGN. FAIRCHILD DOES NOT ASSUME ANY LIABILITY ARISING OUT OF THE APPLICATION OR USE OF ANY PRODUCT OR CIRCUIT DESCRIBED HEREIN; NEITHER DOES IT CONVEY ANY LICENSE UNDER ITS PATENT RIGHTS, NOR THE RIGHTS OF OTHERS. THESE SPECIFICATIONS DO NOT EXPAND THE TERMS OF FAIRCHILD'S WORLDWIDE TERMS AND CONDITIONS, SPECIFICALLY THE WARRANTY THEREIN, WHICH COVERS THESE PRODUCTS.

## LIFE SUPPORT POLICY

FAIRCHILD'S PRODUCTS ARE NOT AUTHORIZED FOR USE AS CRITICAL COMPONENTS IN LIFE SUPPORT DEVICES OR SYSTEMS WITHOUT THE EXPRESS WRITTEN APPROVAL OF FAIRCHILD SEMICONDUCTOR CORPORATION.

As used herein:

1. Life support devices or systems are devices or systems which, (a) are intended for surgical implant into the body, or (b) support or sustain life, or (c) whose failure to perform when properly used in accordance with instructions for use provided in the labeling, can be reasonably expected to result in significant injury to the user.
2. A critical component is any component of a life support device or system whose failure to perform can be reasonably expected to cause the failure of the life support device or system, or to affect its safety or effectiveness.

## PRODUCT STATUS DEFINITIONS

### Definition of Terms

Datasheet Identification	Product Status	Definition
Advance Information	Formative or In Design	This datasheet contains the design specifications for product development. Specifications may change in any manner without notice.
Preliminary	First Production	This datasheet contains preliminary data, and supplementary data will be published at a later date. Fairchild Semiconductor reserves the right to make changes at any time without notice in order to improve design.
No Identification Needed	Full Production	This datasheet contains final specifications. Fairchild Semiconductor reserves the right to make changes at any time without notice in order to improve design.
Obsolete	Not In Production	This datasheet contains specifications on a product that has been discontinued by Fairchild semiconductor. The datasheet is printed for reference information only.

Rev. 119