

- Industry Standard Package and Circuits
- Power Control Building Blocks

Modules come in an industry standard package, offering nine circuits that can be used singly or as power control building blocks. All models feature highly efficient thermal management for greatly extended cycle life and are UL recognized (file no. E72445). Manufactured in Crydom's ISO 9001 Certified facility for optimum product performance and reliability.

PART NUMBER IDENTIFICATION

Series Type
F18-Case style

Current
27 - 25 Amps
42 - 40 Amps
57 - 55 Amps
92 - 90 Amps
107 - 105 Amps

Circuit Type
(see schematic diagrams)
Example: SD

Voltage
400 - 120 Vac
600 - 240 Vac
1000 - 380 Vac
1200 - 480 Vac
1400 - 530 Vac
1600 - 600 Vac

Example: F1892SD1200

ELECTRICAL SPECIFICATIONS ^①

SYMBOL SPECIFICATION		RATINGS				
		27	42	57	92	107 ^②
I_D	Maximum DC Output Current ($T_c = 85^\circ\text{C}$) [A]	25	40	55	90	105
V_F	Maximum Voltage Drop	1.55V @ 75Apk	1.4V @ 120Apk	1.4V @ 165Apk	1.4V @ 270Apk	1.65V @ 300Apk
T_J	Operating Junction Temperature Range	-40°C to +125°C				
di/dt	Critical Rate of Rise of On-State Current @ $T_J=125^\circ\text{C}$ [A/ μs]	100	100	100	100	100
dv/dt	Critical Rate of Rise of Off-State Voltage [V/ μs]	1000	1000	1000	1000	1000
V_{RRM}	Repetitive Peak Reverse Voltage (AC Line Nominal) [Vpk]	400 (120 Vac) 600 (240 Vac) 1000 (380 Vac) 1200 (480 Vac) 1400 (530 Vac) 1600 (600 Vac)				
I_{TSM}	Maximum Non-Repetitive Surge Current ($1/2$ Cycle, 60Hz) [A]	400	1000	1500	1950	2250
I^2T	Maximum I^2T for Fusing ($t=8.3\text{ms}$) [A ² sec]	670	4150	9350	15800	25000
I_{GT}	Maximum Required Gate Current to Trigger @ 25°C [mA]	150	150	150	150	150
V_{GT}	Maximum Required Gate Voltage to Trigger @ 25°C [V]	3.0	3.0	3.0	3.0	3.0
$P_{G(AV)}$	Average Gate Power [W]	0.5	0.5	0.5	0.5	0.5
V_{GM}	Maximum Peak Gate Voltage (Reverse) [V]	5.0	5.0	5.0	5.0	5.0
$R_{\theta JC}$	Maximum Thermal Resistance Junction to Ceramic Base per Chip [°C/W]	0.4	0.28	0.25	0.14	0.135
V_{ISOL}	Isolation Voltage [VRMS]	2500	2500	2500	2500	2500

MECHANICAL SPECIFICATIONS

Weight: (typical)

4.75 oz. (135g)

Torque Required

Terminal Stud Screw : 30 inch lb
Mounting Screw : 20 inch lb

GENERAL NOTES

- ① All parameters at 25°C unless otherwise specified.
- ② Available only in SD and SDK circuit configuration.

© 2003 CRYDOM CORP Specifications subject to change without notice.

- Industry Standard Package and Circuits
- Power Control Building Blocks

MECHANICAL DIMENSIONS

All dimensions are in inches (millimeters)

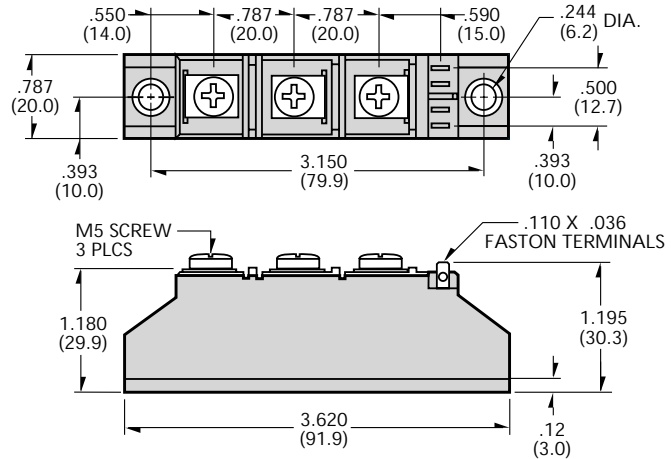

SERIES F18 CIRCUITS

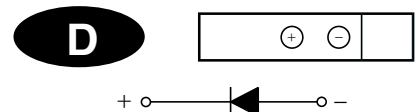
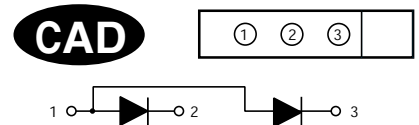
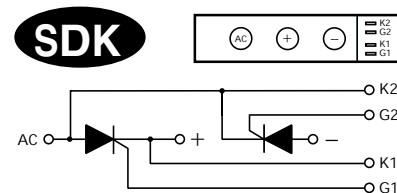
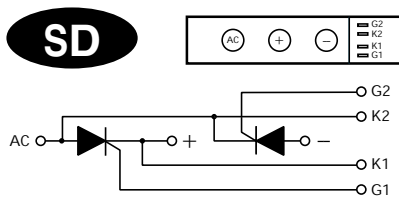
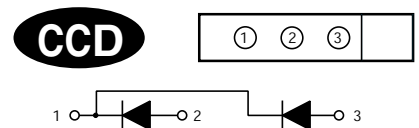
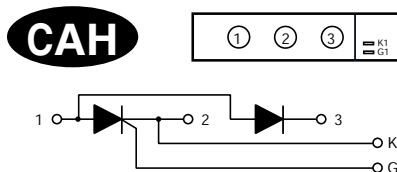
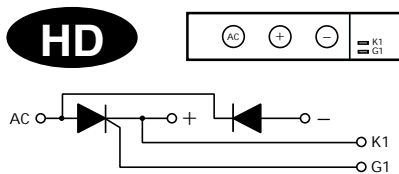
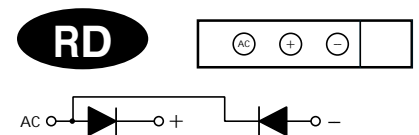
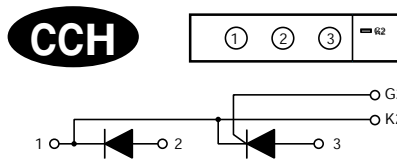
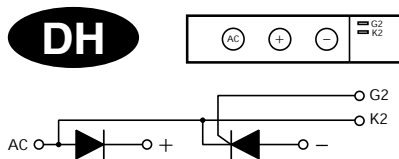

© 2003 CRYDOM CORP Specifications subject to change without notice.