



15ETX06PbF 15ETX06FPPbF

Hyperfast Rectifier

Features

- Benchmark Ultra-low Forward Voltage Drop
- Hyperfast Recovery Time
- Low Leakage Current
- 175°C Operating Junction Temperature
- Fully Isolated package ($V_{INS} = 2500 V_{RMS}$)
- Lead-Free ("PbF" suffix)

$t_{rr} = 18 \text{ ns}$
$I_{F(AV)} = 15 \text{ Amp}$
$V_R = 600 \text{ V}$

Description/ Applications

State of the art Hyperfast recovery rectifiers designed with optimized performance of forward voltage drop, Hyperfast recover time, and soft recovery.

The planar structure and the platinum doped life time control guarantee the best overall performance, ruggedness and reliability characteristics.



These devices are intended for use in PFC Boost stage in the AC-DC section of SMPS, inverters or as freewheeling diodes.

The IR extremely optimized stored charge and low recovery current minimize the switching losses and reduce over dissipation in the switching element and snubbers.

Absolute Maximum Ratings

Parameters	Max	Units
V_{RRM} Peak Repetitive Reverse Voltage	600	V
$I_{F(AV)}$ Average Rectified Forward Current @ $T_C = 133^\circ\text{C}$ @ $T_C = 62^\circ\text{C}$ (FULLPACK)	15	A
I_{FSM} Non Repetitive Peak Surge Current @ $T_J = 25^\circ\text{C}$	170	
I_{FM} Peak Repetitive Forward Current	30	
T_J, T_{STG} Operating Junction and Storage Temperatures	- 65 to 175	$^\circ\text{C}$

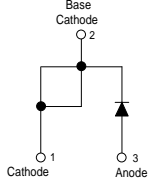
Case Styles

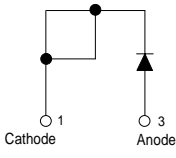
<p>15ETX06</p>   <p>TO-220AC</p>	<p>15ETX06FP</p>   <p>TO-220 FULLPACK</p>
--	---

Electrical Characteristics @ T_J = 25°C (unless otherwise specified)

Parameters	Min	Typ	Max	Units	Test Conditions
V _{BR} , V _r Breakdown Voltage, Blocking Voltage	600	-	-	V	I _R = 100μA
V _F Forward Voltage	-	2.3	3.2	V	I _F = 15A, T _J = 25°C
	-	1.5	1.8	V	I _F = 15A, T _J = 150°C
I _R Reverse Leakage Current	-	0.1	50	μA	V _R = V _R Rated
	-	40	300	μA	T _J = 150°C, V _R = V _R Rated
C _T Junction Capacitance	-	20	-	pF	V _R = 600V
L _S Series Inductance	-	8.0	-	nH	Measured lead to lead 5mm from package body

Dynamic Recovery Characteristics @ T_C = 25°C (unless otherwise specified)

Parameters	Min	Typ	Max	Units	Test Conditions
t _{rr} Reverse Recovery Time	-	18	22	ns	I _F = 1A, di _F /dt = 100A/μs, V _R = 30V
	-	20	32		I _F = 15A, di _F /dt = 100A/μs, V _R = 30V
	-	22	-		T _J = 25°C
	-	52	-		T _J = 125°C
I _{RRM} Peak Recovery Current	-	2.4	-	A	T _J = 25°C
	-	5.1	-		T _J = 125°C
Q _{rr} Reverse Recovery Charge	-	25	-	nC	T _J = 25°C
	-	150	-		T _J = 125°C
t _{rr} Reverse Recovery Time	-	37	-	ns	T _J = 125°C
I _{RRM} Peak Recovery Current	-	16	-	A	T _J = 125°C
Q _{rr} Reverse Recovery Charge	-	350	-	nC	T _J = 125°C

Thermal - Mechanical Characteristics

Parameters	Min	Typ	Max	Units
T _J Max. Junction Temperature Range	-	-	175	°C
T _{Stg} Max. Storage Temperature Range	- 65	-	175	
R _{thJC} Thermal Resistance, Junction to Case	-	Per Leg	1.0	°C/W
		Fullpack (Per Leg)	3.0	
R _{thJA} ① Thermal Resistance, Junction to Ambient	-	-	70	°C/W
R _{thCS} ② Thermal Resistance, Case to Heatsink	-	0.5	-	
Weight	-	2.0	-	g
	-	0.07	-	(oz)
Mounting Torque	6.0	-	12	Kg-cm
	5.0	-	10	lbf.in

① Typical Socket Mount

② Mounting Surface, Flat, Smooth and Greased

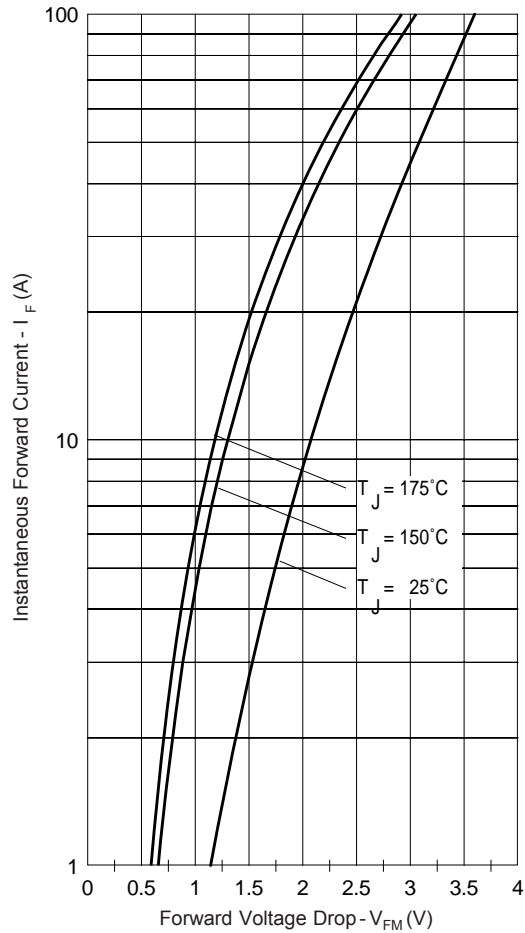

Fig. 1 - Typical Forward Voltage Drop Characteristics

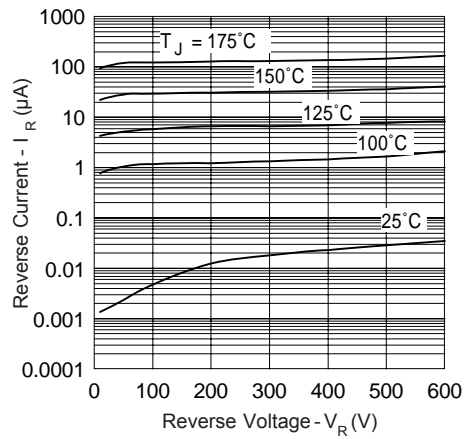

Fig. 2 - Typical Values Of Reverse Current Vs. Reverse Voltage

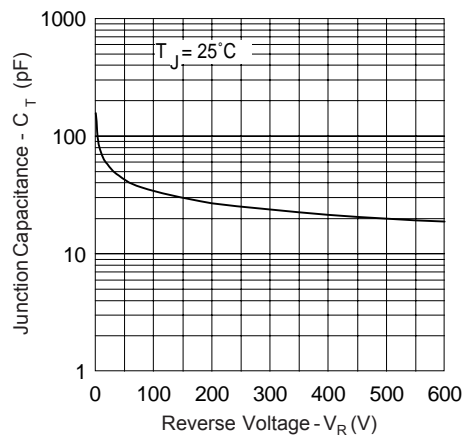

Fig. 3 - Typical Junction Capacitance Vs. Reverse Voltage

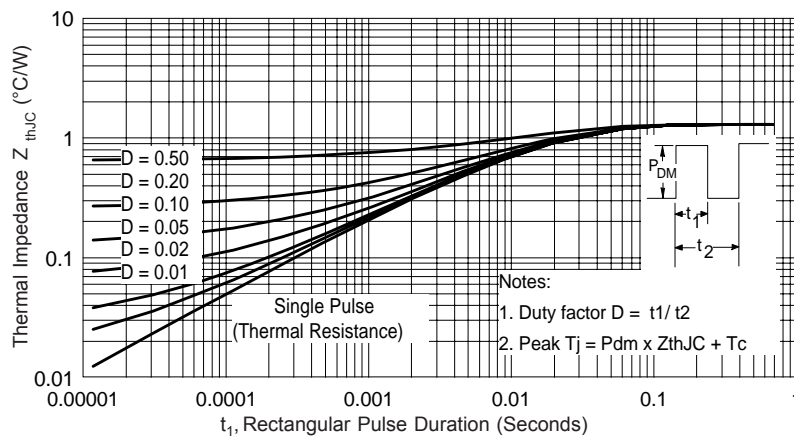

Fig. 4 - Max. Thermal Impedance Z_{thJC} Characteristics

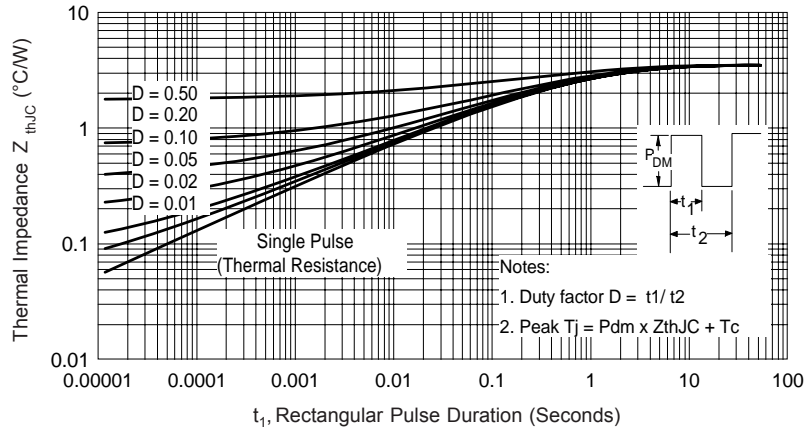

Fig. 5 - Max. Thermal Impedance Z_{thJC} Characteristics (FULLPACK)

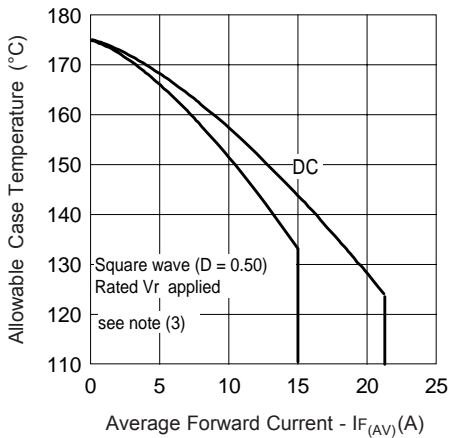

Fig. 6 - Max. Allowable Case Temperature Vs. Average Forward Current

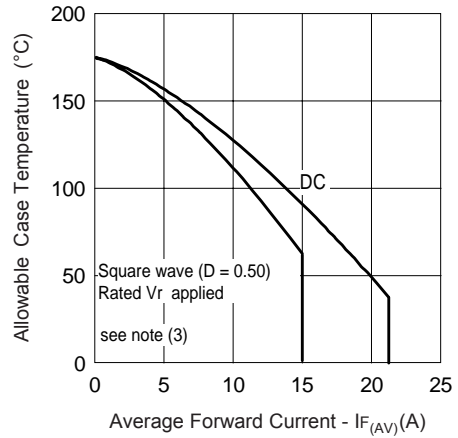

Fig. 7 - Max. Allowable Case Temperature Vs. Average Forward Current (FULLPACK)

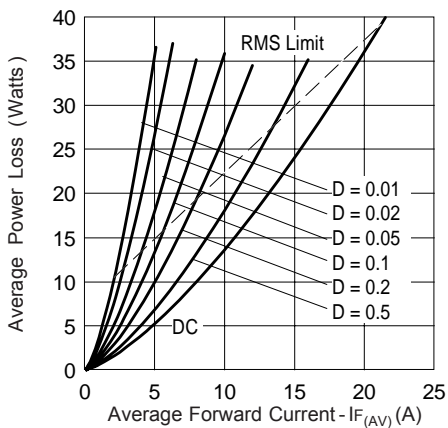

Fig. 8 - Forward Power Loss Characteristics

(3) Formula used: $T_c = T_j - (Pd + Pd_{REV}) \times R_{thJC}$;
 Pd = Forward Power Loss =
 $I_{F(AV)} \times V_{FM} @ (I_{F(AV)} / D)$
 (see Fig. 8);
 Pd_{REV} = Inverse Power Loss = $V_{R1} \times I_R (1 - D)$;
 $I_R @ V_{R1}$ = rated V_R

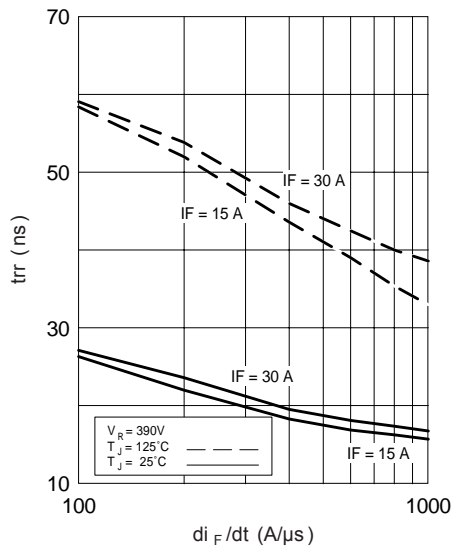

Fig. 9 - Typical Reverse Recovery vs. di_F/dt

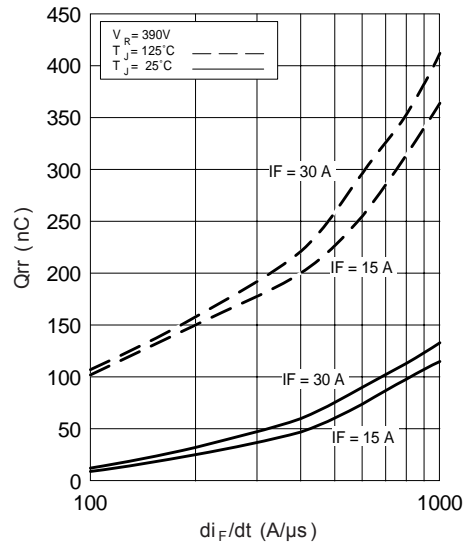

Fig. 10 - Typical Stored Charge vs. di_F/dt

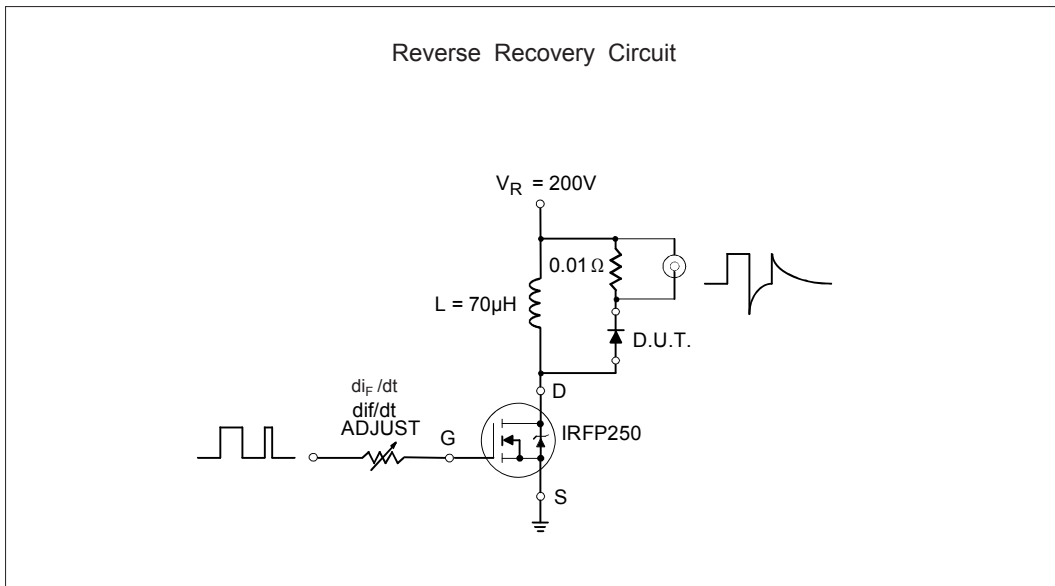

Fig. 11 - Reverse Recovery Parameter Test Circuit

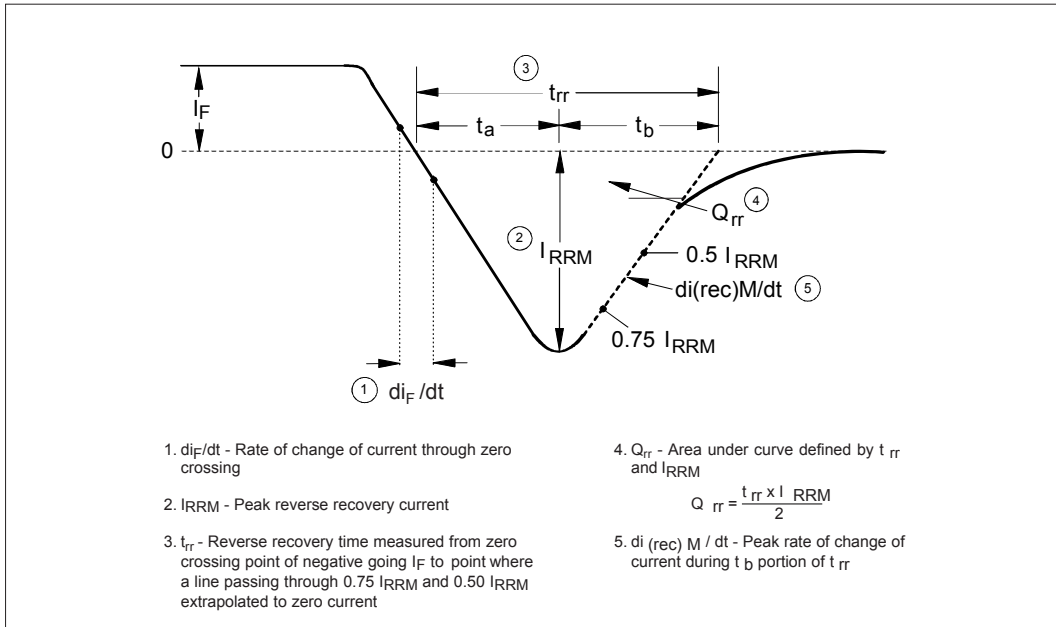
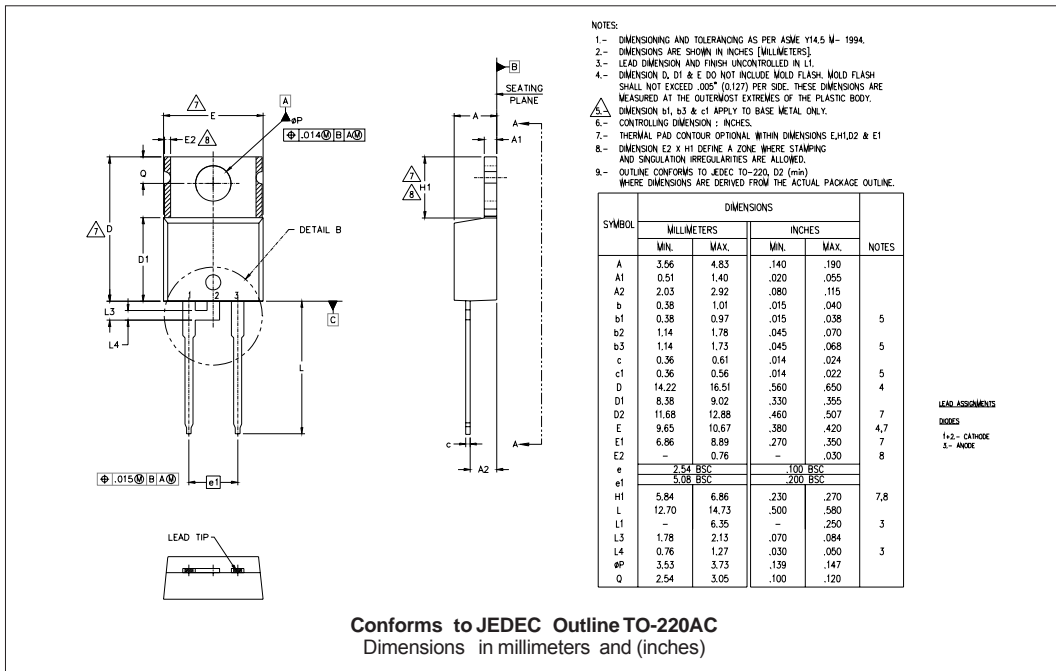
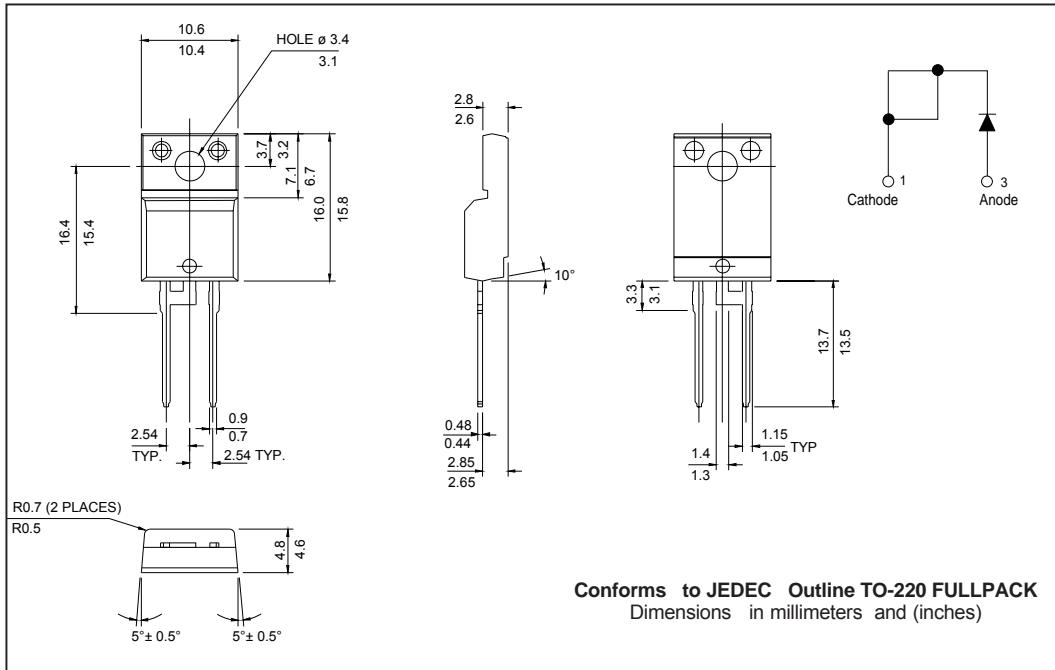

Fig. 12 - Reverse Recovery Waveform and Definitions

Outline Table



Outline Table



Part Marking Information (TO-220)

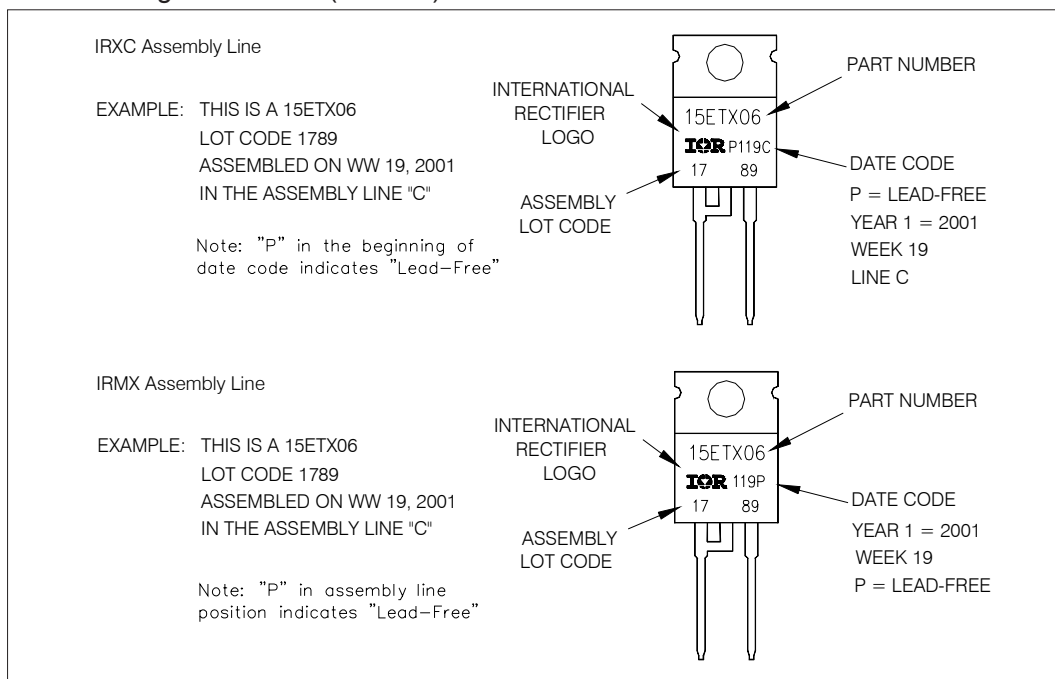

Part Marking Information (TO-220 FULL-PAK)

EXAMPLE: THIS IS A 15ETX06FP
LOT CODE 1789
ASSEMBLED ON WW 19, 2002
IN THE ASSEMBLY LINE "C"

Note: "P" in assembly line position indicates "Lead-Free"

Ordering Information Table

Device Code						
15	E	T	X	06	FP	PbF
①	②	③	④	⑤	⑥	⑦
1	- Current Rating (15 = 15A)					
2	- E = Single Diode					
3	- T = TO-220, D ² Pak					
4	- X = HyperFast Recovery					
5	- Voltage Rating (06 = 600V)					
6	- • none = TO-220AC • FP = TO-220 FULLPACK					
7	- • none = Standard Production • PbF = Lead-Free					

Tube Standard Pack Quantity: 50 pieces

Data and specifications subject to change without notice.
This product has been designed and qualified for Industrial Level and Lead-Free.
Qualification Standards can be found on IR's Web site.