



# Dual-/Triple-Voltage, Power-Supply Sequencers/Supervisors

MAX6880-MAX6883

## General Description

The MAX6880–MAX6883 dual-/triple-voltage monitors are designed to sequence power supplies during power-up condition. When all of the voltages exceed their respective thresholds, these devices turn on voltages to the system sequentially, enhancing n-channel MOSFETs used as switches. The time between each sequenced voltage is determined by an external capacitor, thus allowing flexibility in delay timing. The MAX6880/MAX6881 sequence three voltages and the MAX6882/MAX6883 sequence two voltages.

These devices initially monitor all of the voltages and when all of them are within their tolerances, the internal charge pumps enhance external n-channel MOSFETs in a sequential manner to apply the voltages to the system. Internal charge pumps drive the gate voltages 5V above the respective input voltage thereby ensuring the MOSFETs are fully enhanced to reduce the on-resistance.

The MAX6880–MAX6883 feature capacitor-adjustable slew-rate control to provide controlled turn-on characteristics. After all of the voltages reach 92.5% of their final value, a power-good output (MAX6880/MAX6882) signal is active. The power-good output (PG/RST) can be delayed with an external capacitor to create a power-on reset delay. After the initial power-up phase, the MAX6880–MAX6883 continue to monitor the voltages. If any of the voltages falls below its threshold, the MOSFETs are quickly turned off and the voltages are tracked down together. An internal 100Ω pull-down resistor ensures that the capacitance at the MOSFET's source is discharged quickly. The power-good output goes low to provide a system reset.

The MAX6880–MAX6883 are available in small 4mm x 4mm 24-pin and 16-pin thin QFN packages and specified over the -40°C to +85°C extended operating temperature range.

## Applications

- Multivoltage Systems
- Networking Systems
- Telecom
- Storage Equipment
- Servers/Workstations

**Selector Guide appears at end of data sheet.**

## Features

- ◆ Capacitor-Adjustable Power-Up Sequencing Delay
- ◆ Internal Charge Pumps to Enhance External n-Channel FETs
- ◆ Capacitor-Adjustable Timeout Period Power-Good Output (MAX6880/MAX6882)
- ◆ Adjustable Undervoltage Lockout or Logic-Enable Input
- ◆ Internal 100Ω Pulldown for Each Output to Discharge Capacitive Load Quickly
- ◆ 0.5V to 5.5V Nominal IN\_/OUT\_ Range
- ◆ 2.7V to 5.5V Operating Voltage Range
- ◆ Immune to Short Voltage Transients
- ◆ Small 4mm x 4mm 24-Pin or 16-Pin Thin QFN Packages

## Ordering Information

| PART        | TEMP RANGE     | PIN-PACKAGE | PKG CODE |
|-------------|----------------|-------------|----------|
| MAX6880ETG+ | -40°C to +85°C | 24 Thin QFN | T2444-4  |
| MAX6881ETE+ | -40°C to +85°C | 16 Thin QFN | T1644-4  |
| MAX6882ETE+ | -40°C to +85°C | 16 Thin QFN | T1644-4  |
| MAX6883ETE+ | -40°C to +85°C | 16 Thin QFN | T1644-4  |

+Denotes lead-free package.

## Pin Configurations

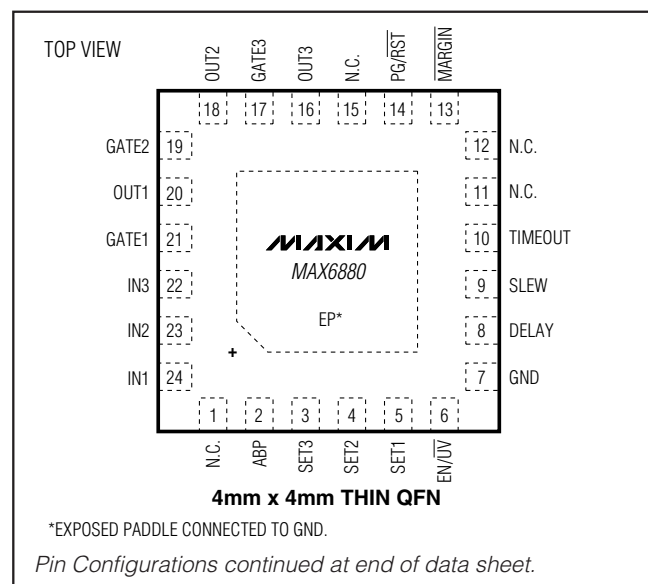

# Dual-/Triple-Voltage, Power-Supply Sequencers/Supervisors

## ABSOLUTE MAXIMUM RATINGS

(All voltages referenced to GND, unless otherwise noted.)

|                      |   |
|----------------------|---|
| IN1, IN2, IN3        | -0.3V to +6V                                  |
| ABP                  | -0.3V to the highest of $V_{IN1}$ - $V_{IN3}$ |
| SET1, SET2, SET3     | -0.3V to +6V                                  |
| GATE1, GATE2, GATE3  | -0.3V to +12V                                 |
| OUT1, OUT2, OUT3     | -0.3V to +6V                                  |
| MARGIN               | -0.3V to +6V                                  |
| PG/RST, EN/UV        | -0.3V to +6V                                  |
| DELAY, SLEW, TIMEOUT | -0.3V to +6V                                  |
| OUT_ Current         | ±50mA   |
| GND Current          | ±50mA   |

|  |                 |
|--|-----------------|
| Input/Output Current (all pins except OUT_ and GND)        | ±20mA           |
| Continuous Power Dissipation ( $T_A = +70^\circ\text{C}$ ) |                 |
| 16-Pin 4mm x 4mm Thin QFN                                  |                 |
| (de rate 16.9mW/°C above +70°C)                            | 1349mW          |
| 24-Pin 4mm x 4mm Thin QFN                                  |                 |
| (de rate 20.8mW/°C above +70°C)                            | 1667mW          |
| Operating Temperature Range                                | -40°C to +85°C  |
| Storage Temperature Range                                  | -65°C to +150°C |
| Maximum Junction Temperature                               | +150°C          |
| Lead Temperature (soldering, 10s)                          | +300°C          |

Stresses beyond those listed under "Absolute Maximum Ratings" may cause permanent damage to the device. These are stress ratings only, and functional operation of the device at these or any other conditions beyond those indicated in the operational sections of the specifications is not implied. Exposure to absolute maximum rating conditions for extended periods may affect device reliability.

## ELECTRICAL CHARACTERISTICS

(IN1, IN2, or IN3 = +2.7V to +5.5V,  $\overline{\text{EN/UV}} = \overline{\text{MARGIN}} = \overline{\text{ABP}}$ ,  $T_A = -40^\circ\text{C}$  to +85°C, unless otherwise specified. Typical values are at  $T_A = +25^\circ\text{C}$ , unless otherwise noted.) (Note 1)

| PARAMETER   | SYMBOL               | CONDITIONS   | MIN    | TYP   | MAX    | UNITS |
|---|----------------------|--|--------|-------|--------|-------|
| Operating Voltage Range                           | IN_                  | Voltage on the highest of IN_ to ensure that PG/RST is valid and GATE_ = 0 | 1.4    |       |        | V     |
|   |                      | Voltage on the highest of IN_ to ensure the device is fully operational    | 2.7    |       | 5.5    |       |
| Supply Current                                    | I <sub>CC</sub>      | IN1 = 5.5V, IN2 = IN3 = 3.3V, no load                                      |        | 1.1   | 1.8    | mA    |
| SET_ Threshold Range                              | V <sub>TH</sub>      | SET_ falling, $T_A = +25^\circ\text{C}$                                    | 0.4925 | 0.5   | 0.5075 | V     |
|   |                      | SET_ falling, $T_A = -40^\circ\text{C}$ to +85°C                           | 0.4875 | 0.5   | 0.5125 |       |
| SET_ Threshold Hysteresis                         | V <sub>TH_HYST</sub> | SET_ rising  |        | 0.5   |        | %     |
| SET_ Input Current                                | I <sub>SET</sub>     | SET_ = 0.5V  | -100   |       | +100   | nA    |
| EN/UV Input Voltage                               | V <sub>EN_R</sub>    | Input rising   |        | 1.286 |        | V     |
|   | V <sub>EN_F</sub>    | Input falling  | 1.22   | 1.25  | 1.28   |       |
| EN/UV Input Current                               | I <sub>EN</sub>      |  | -5     |       | +5     | µA    |
| EN/UV Input Pulse Width                           | t <sub>EN</sub>      | EN/UV falling, 100mV overdrive   | 7      |       |        | µs    |
| DELAY, TIMEOUT Output Current                     | I <sub>D</sub>       | (Notes 2, 3)   | 2.12   | 2.5   | 2.88   | µA    |
| DELAY, TIMEOUT Threshold Voltage                  |                      | V <sub>CC</sub> = 3.3V   |        | 1.25  |        | V     |
| SLEW Output Current                               | I <sub>S</sub>       | (Note 4)   | 22.5   | 25    | 27.5   | µA    |
| Sequence Slew-Rate Timebase Accuracy              | SR                   | C <sub>SLEW</sub> = 200pF  | -15    |       | +15    | %     |
| Timebase/C <sub>SLEW</sub> Ratio                  |                      | 100pF < C <sub>SLEW</sub> < 1nF  |        | 104   |        | kΩ    |
| Slew-Rate Accuracy during Power-Up and Power-Down |                      | C <sub>SLEW</sub> = 200pF, V <sub>IN_</sub> = 5.5V (Note 4)                | -50    |       | +50    | %     |

# Dual-/Triple-Voltage, Power-Supply Sequencers/Supervisors

MAX6880-MAX6883

## ELECTRICAL CHARACTERISTICS (continued)

(IN1, IN2, or IN3 = +2.7V to +5.5V, EN/ $\overline{UV}$  =  $\overline{MARGIN}$  = ABP, T<sub>A</sub> = -40°C to +85°C, unless otherwise specified. Typical values are at T<sub>A</sub> = +25°C, unless otherwise noted.) (Note 1)

|   |                       |  |                        |                        |                        |    |
|---|-----------------------|--|------------------------|------------------------|------------------------|----|
| Power-Good Threshold                    | V <sub>TH_PG</sub>    | V <sub>OUT_</sub> falling  | 91.5                   | 92.5                   | 93.5                   | %  |
| Power-Good Threshold Hysteresis         | V <sub>HYS_PG</sub>   | V <sub>OUT_</sub> rising   | 0.5                    |                        |                        | %  |
| GATE_ Output High                       | V <sub>GOH</sub>      | I <sub>SOURCE</sub> = 0.5μA  | I <sub>N_+</sub> + 4.2 | I <sub>N_+</sub> + 5.0 | I <sub>N_+</sub> + 5.8 | V  |
| GATE_ Pullup Current                    | I <sub>GUP</sub>      | During power-up and power-down, V <sub>GATE_</sub> = 1V  | 2.5                    | 4                      |                        | μA |
| GATE_ Pulldown Current                  | I <sub>GD</sub>       | During power-up and power-down, V <sub>GATE_</sub> = 5V  | 2.5                    | 4                      |                        | μA |
|   | I <sub>GDS</sub>      | When disabled, V <sub>GATE_</sub> = 5V, V <sub>IN_</sub> ≥ 2.7V  | 9.5                    |                        |                        | mA |
|   |                       | When disabled, V <sub>GATE_</sub> = 5V, V <sub>IN_</sub> ≥ 4V  | 20                     |                        |                        |    |
| SET_ to GATE_ Delay                     | t <sub>D-GATE</sub>   | SET falling, 25mV overdrive  | 10                     |                        |                        | μs |
| PG/ $\overline{RST}$ Output Low         | V <sub>OL</sub>       | V <sub>IN_</sub> ≥ 2.7V, I <sub>SINK</sub> = 1mA, output asserted  | 0.3                    |                        |                        | V  |
|   |                       | V <sub>IN_</sub> ≥ 4.0V, I <sub>SINK</sub> = 4mA, output asserted  | 0.4                    |                        |                        |    |
| Tracking Differential Voltage Stop Ramp | V <sub>TRK</sub>      | Differential between each of the OUT_ and the ramp voltage during power-up and power-down, Figure 1 (Note 5) | 75                     | 125                    | 180                    | mV |
| Tracking Differential Fault Voltage     | V <sub>TRK_F</sub>    | Differential between each of the OUT_ and the ramp voltage, Figure 1 (Note 5)                                | 200                    | 250                    | 310                    | mV |
| Power-Low Threshold                     | V <sub>TH_PL</sub>    | OUT_ falling   | 125                    | 142                    | 170                    | mV |
| Power-Low Hysteresis                    | V <sub>TH_PLHYS</sub> | OUT_ rising  | 10                     |                        |                        | mV |
| OUT to GND Pulldown Impedance           |                       | I <sub>N_</sub> > 2.7V (Note 6)  | 100                    |                        |                        | Ω  |
| $\overline{MARGIN}$ Pullup Current      | I <sub>IN</sub>       |  | 7                      | 10                     | 13                     | μA |
| $\overline{MARGIN}$ Input Voltage       | V <sub>IL</sub>       |  | 0.8                    |                        |                        | V  |
|   | V <sub>IH</sub>       |  | 2.0                    |                        |                        |    |
| $\overline{MARGIN}$ Glitch Rejection    |                       |  | 100                    |                        |                        | ns |

**Note 1:** Specifications guaranteed for the stated global conditions. 100% production tested at T<sub>A</sub> = +25°C and T<sub>A</sub> = +85°C. Specifications at T<sub>A</sub> = -40°C to +85°C are guaranteed by design. These devices meet the parameters specified when at least one of IN1/IN2/IN3 is between 2.7V to 5.5V, while the remaining IN1/IN2/IN3 are between 0 and 5.5V.

**Note 2:** A current I<sub>D</sub> = 2.5μA ±15% is generated internally and is used to set the DELAY and TIMEOUT periods and used as a reference for t<sub>DELAY</sub> and t<sub>TIMEOUT</sub>.

**Note 3:** The total DELAY is t<sub>DELAY</sub> = 200μs + (500kΩ × C<sub>DELAY</sub>). Leave DELAY unconnected for 200μs delay. The total TIMEOUT is t<sub>TIMEOUT</sub> = 200μs + (500kΩ × C<sub>TIMEOUT</sub>). Leave TIMEOUT unconnected for 200μs timeout.

**Note 4:** A current I<sub>S</sub> = 25μA ±10% is generated internally and used as a reference for t<sub>FAULT</sub>, t<sub>RETRY</sub>, and slew rate.

**Note 5:** During power-up, only the condition OUT\_ < ramp - V<sub>TRK</sub> is checked in order to stop the ramp. However, both conditions OUT\_ < ramp - V<sub>TRK\_F</sub> and OUT\_ > ramp + V<sub>TRK\_F</sub> cause a fault. During power-down, only the condition OUT > ramp + V<sub>TRK</sub> is checked in order to stop the ramp. However, both conditions OUT\_ < ramp - V<sub>TRK\_F</sub> and OUT\_ > ramp + V<sub>TRK\_F</sub> cause a fault (see Figure 10). Therefore, if OUT1, OUT2, and OUT3 (during power-up tracking and power-down) differ by more than 2 × V<sub>TRK\_F</sub>, a fault condition is asserted.

**Note 6:** A 100Ω pulldown to GND activated by a fault condition. See the *Internal Pulldown* section.

# Dual-/Triple-Voltage, Power-Supply Sequencers/Supervisors

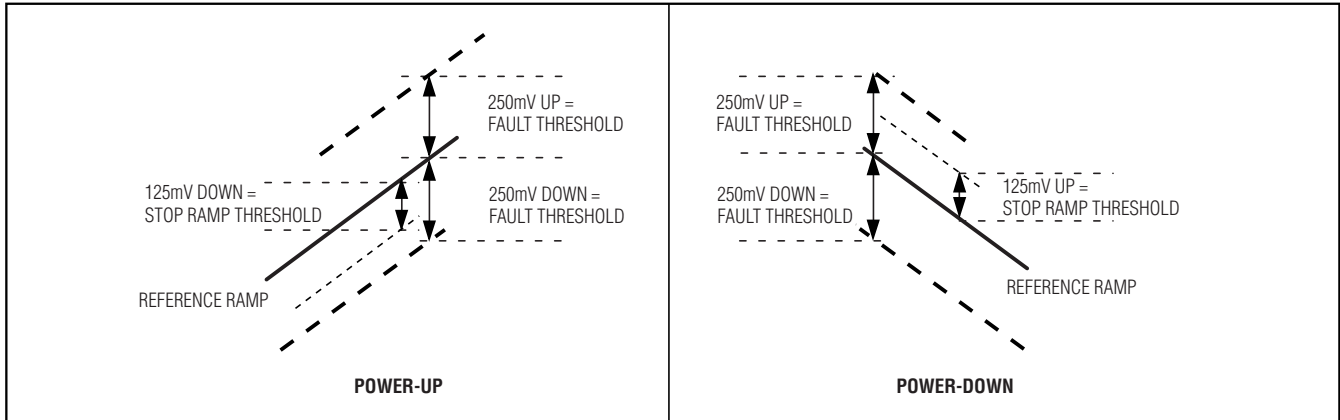

Figure 1. Stop Ramp/Fault Window During Power-Up and Power-Down

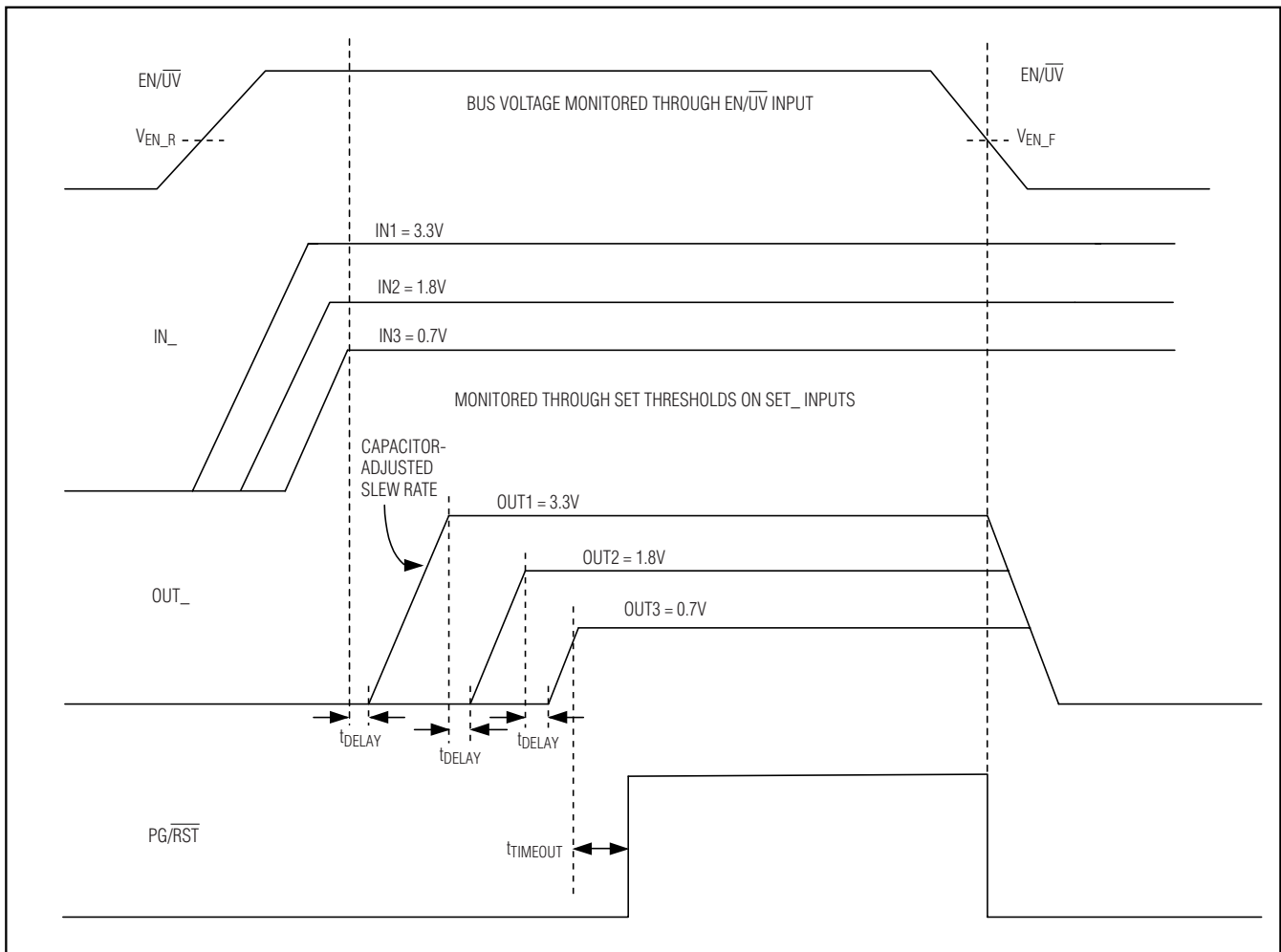

Figure 2. Sequencing In Normal Mode

# Dual-/Triple-Voltage, Power-Supply Sequencers/Supervisors

MAX6880-MAX6883

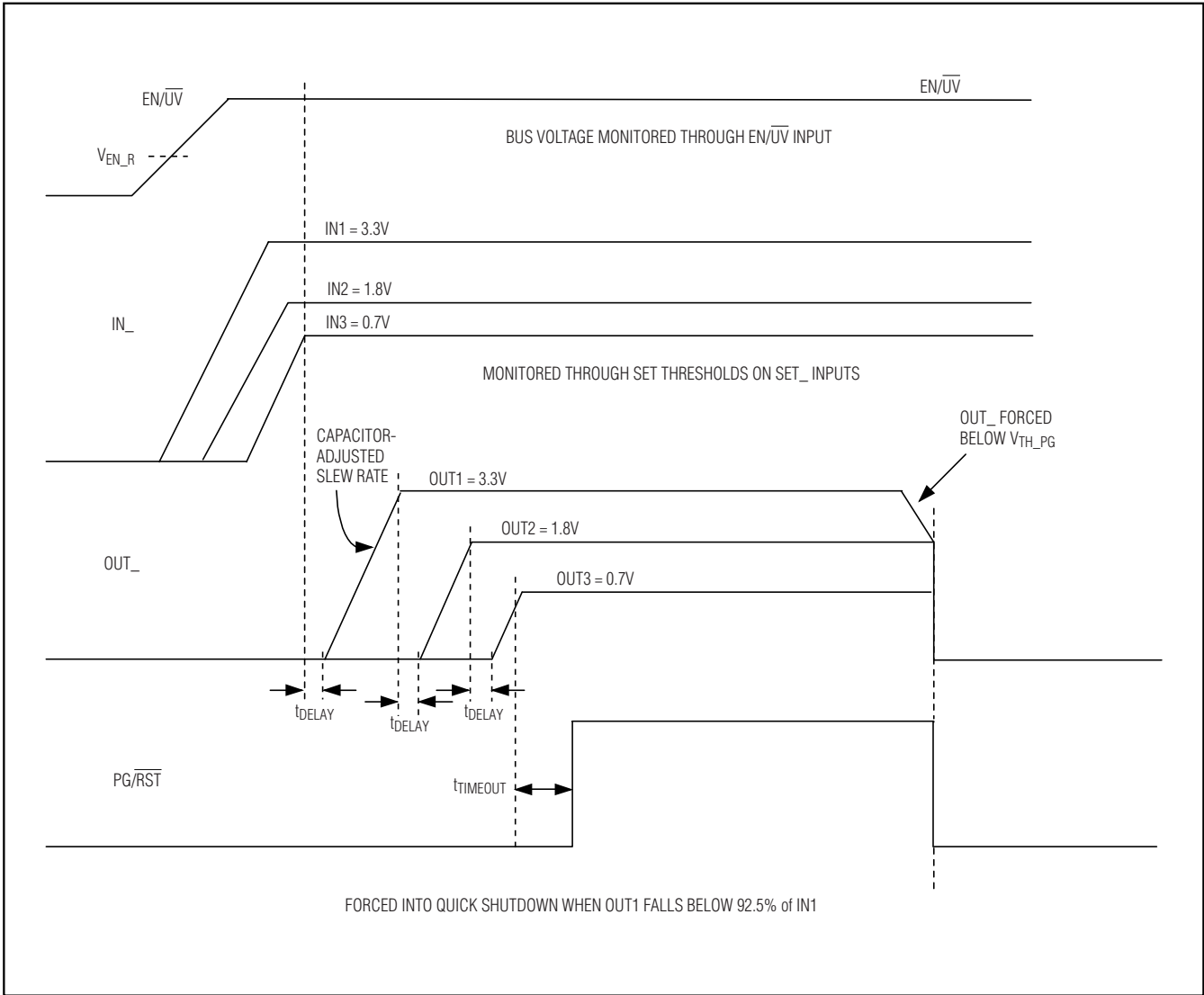

Figure 3. Sequencing In Fast Shutdown Mode

# Dual-/Triple-Voltage, Power-Supply Sequencers/Supervisors

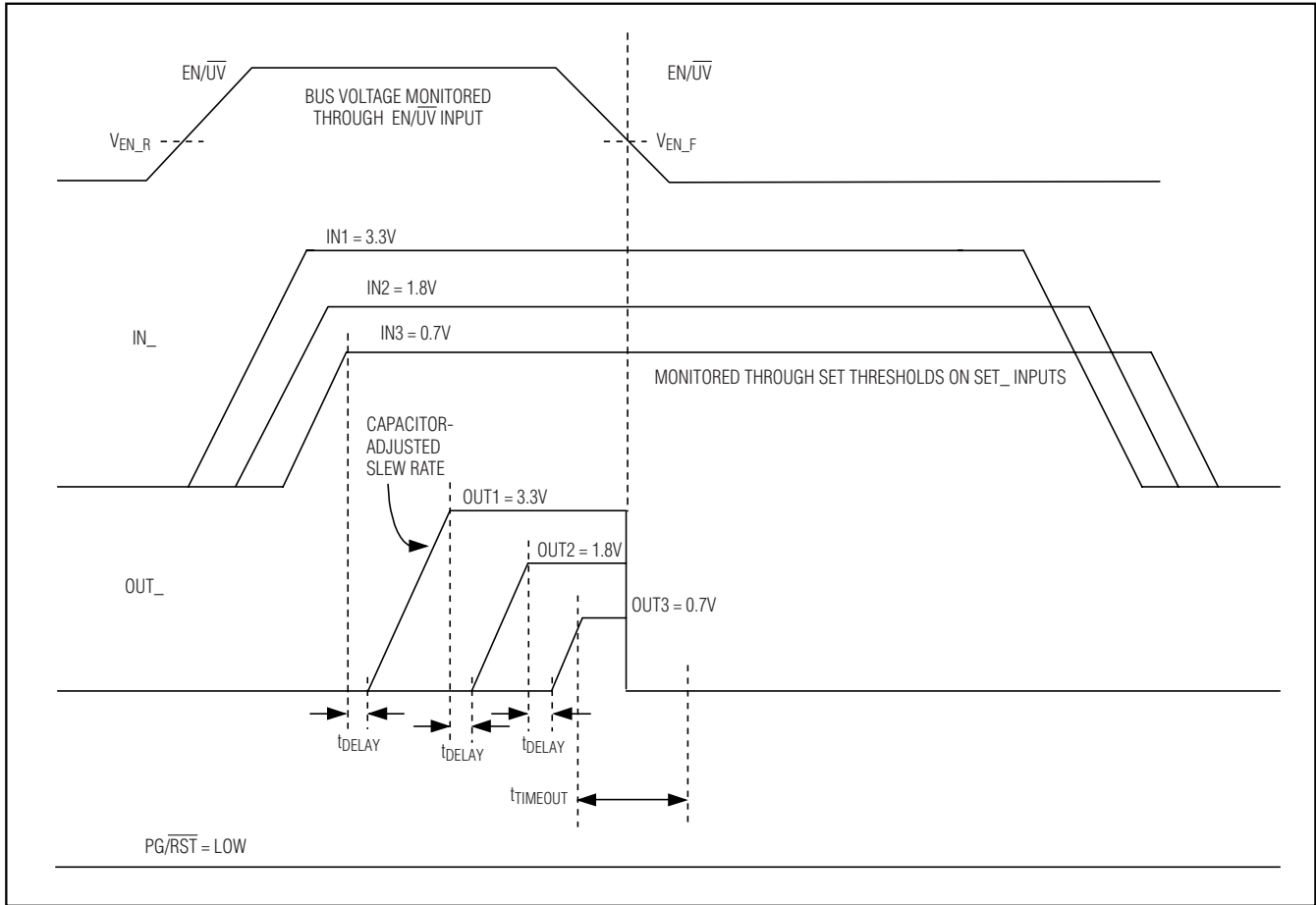

Figure 4. Timing Diagram (Aborted Sequencing)

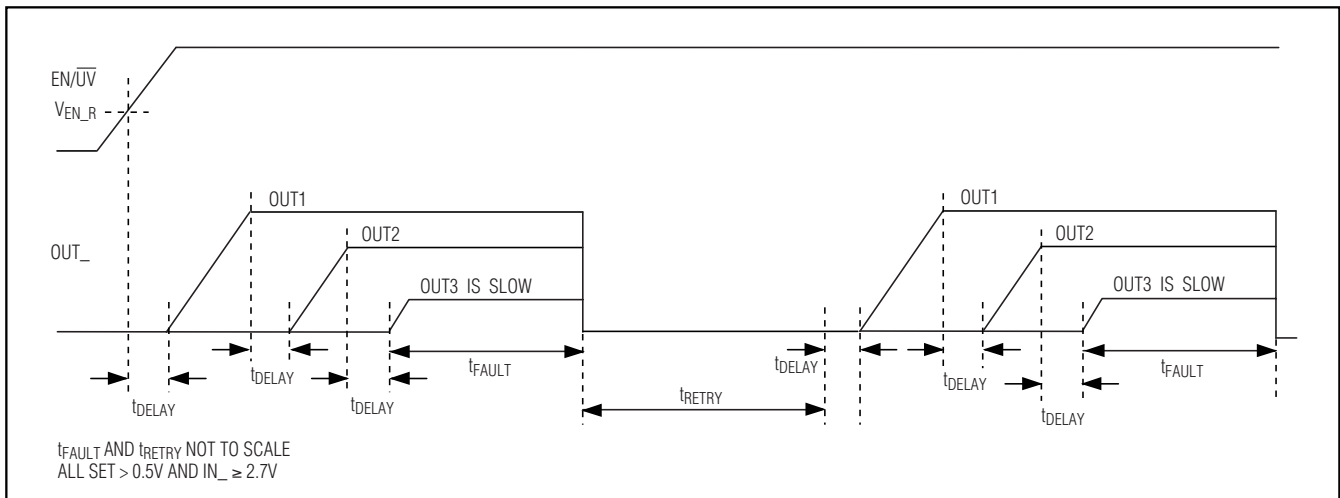

Figure 5.  $t_{FAULT}$  and  $t_{RETRY}$  Timing Diagram in Sequencing

# Dual-/Triple-Voltage, Power-Supply Sequencers/Supervisors

## Typical Operating Characteristics

( $V_{IN\_}$  = 2.7V to 5.5V,  $C_{SLEW}$  = 200pF, EN = MARGIN = ABP,  $T_A$  = +25°C, unless otherwise noted.)

MAX6880-MAX6883

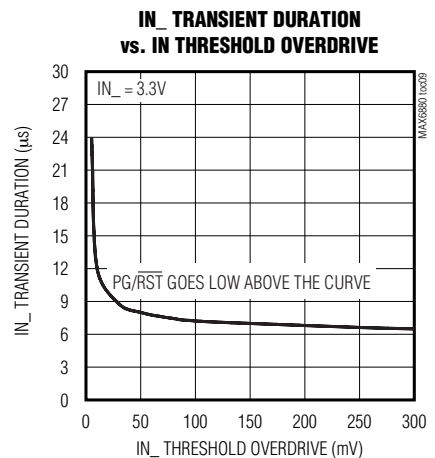
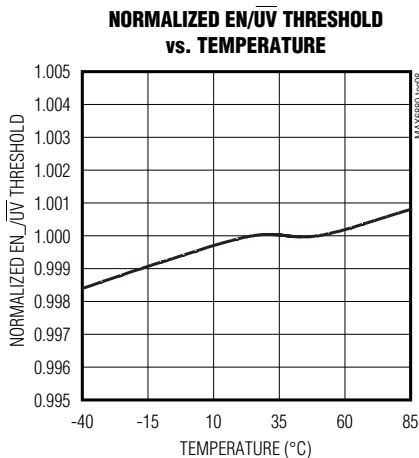
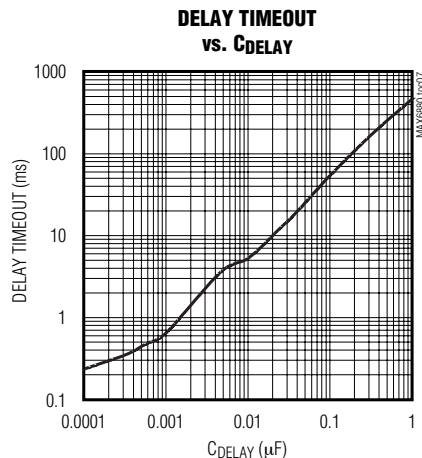
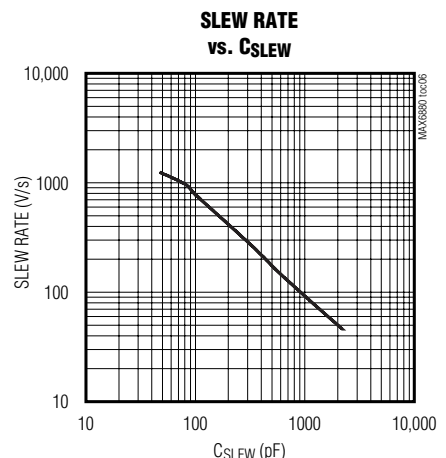
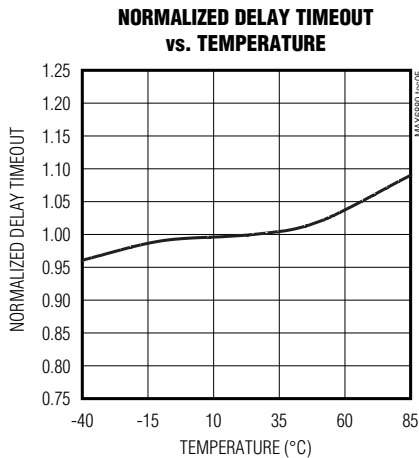
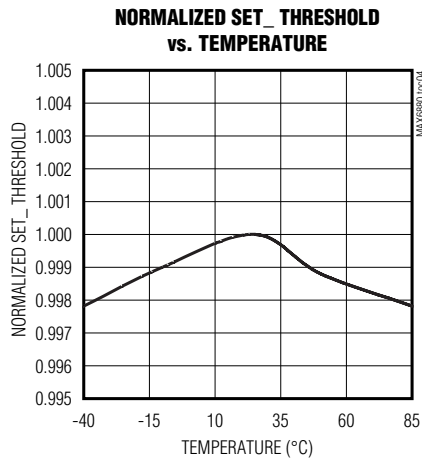
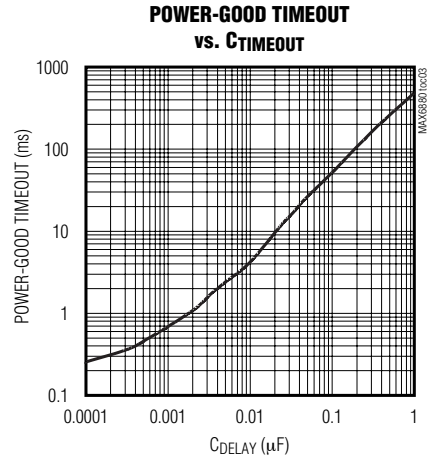
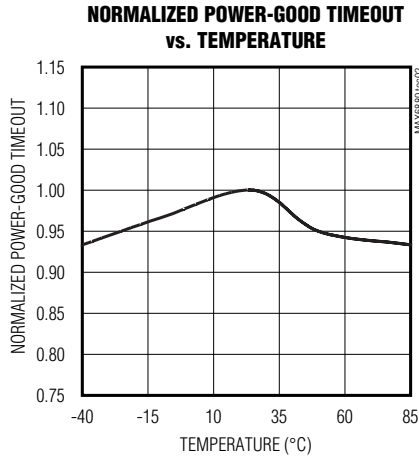
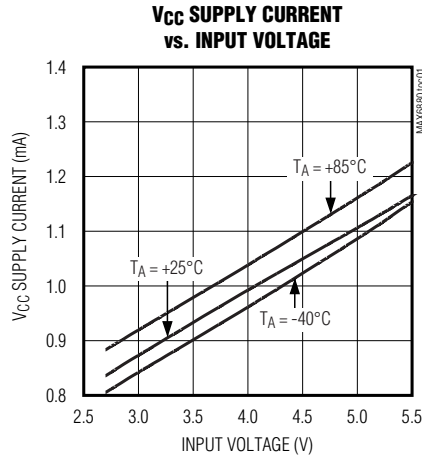

# Dual-/Triple-Voltage, Power-Supply Sequencers/Supervisors

## Typical Operating Characteristics (continued)

( $V_{IN\_}$  = 2.7V to 5.5V,  $C_{SLEW}$  = 200pF, EN = MARGIN = ABP,  $T_A$  = +25°C, unless otherwise noted.)

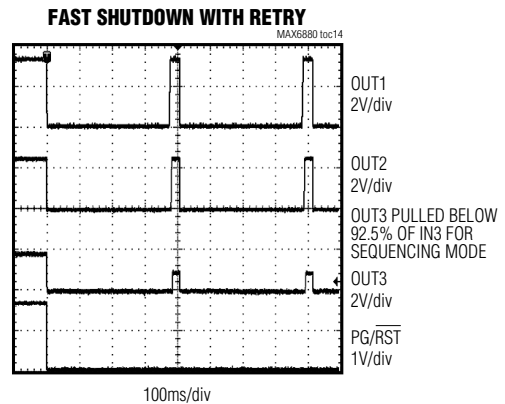
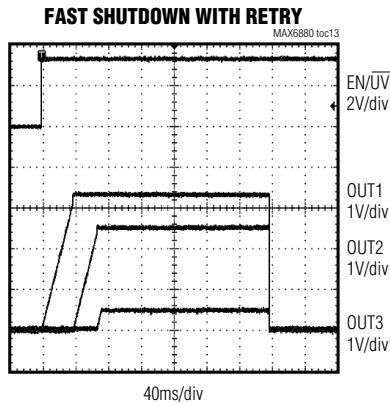
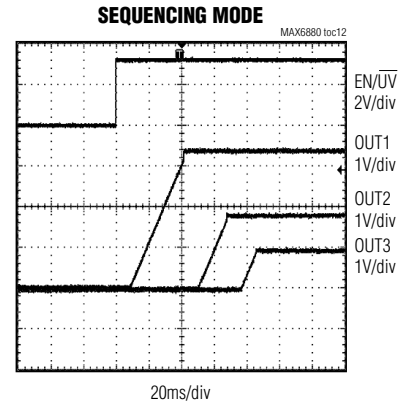
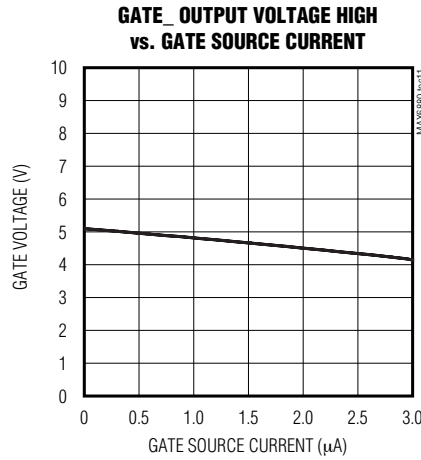
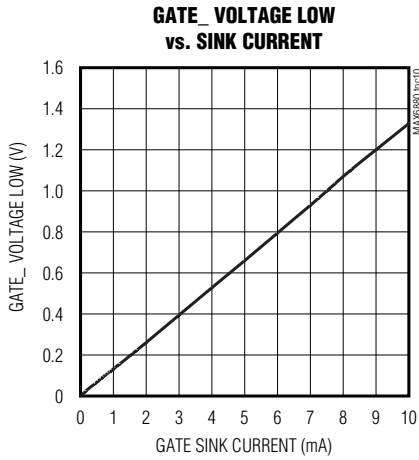



# Dual-/Triple-Voltage, Power-Supply Sequencers/Supervisors

## Pin Description

MAX6880-MAX6883

| PIN           |         |         |             | NAME                | FUNCTION  |
|---------------|---------|---------|-------------|---------------------|---|
| MAX6880       | MAX6881 | MAX6882 | MAX6883     |                     |   |
| 1, 11, 12, 15 | —       | —       | 1, 8, 9, 10 | N.C.                | No Connection. Not internally connected.  |
| 2             | —       | 1       | —           | ABP                 | Internal Supply Bypass Input. Bypass ABP with a 1 $\mu$ F capacitor to GND. ABP maintains the device supply voltage during rapid power-down conditions.   |
| 3             | 2       | —       | —           | SET3                | Externally Adjusted IN_ Undervoltage Lockout Threshold. Connect SET_ to an external resistor-divider network to set the desired undervoltage threshold for each IN_ supply (see the <i>Typical Application Circuit</i> ). All SET_ inputs must be above the internal SET_ threshold (0.5V) to enable sequencing functionality.  |
| 4             | 3       | 2       | 2           | SET2                |   |
| 5             | 4       | 3       | 3           | SET1                |   |
| 6             | 5       | 4       | 4           | EN/ $\overline{UV}$ | Logic-Enable Input or Undervoltage Lockout Monitor Input. EN/ $\overline{UV}$ must be high (EN/ $\overline{UV}$ > V <sub>EN_R</sub> ) to enable voltage sequencing power-up operation. OUT_ begins tracking down when EN/ $\overline{UV}$ < V <sub>EN_F</sub> . Connect EN/ $\overline{UV}$ to an external resistor-divider network to set the external UVLO threshold. |
| 7             | 6       | 5       | 5           | GND                 | Ground  |
| 8             | 7       | 6       | 6           | DELAY               | Sequence Delay Select Input. Connect a capacitor from DELAY to GND to select the desired delay period before sequencing is enabled (after all SET_ inputs and EN/ $\overline{UV}$ are above their respective thresholds) or between supply sequences. Leave DELAY unconnected for the default 200 $\mu$ s delay period.   |
| 9             | 8       | 7       | 7           | SLEW                | Slew-Rate Adjustment Input. Connect a capacitor from SLEW to GND to select the desired OUT_ slew rate.  |
| 10            | —       | 8       | —           | TIMEOUT             | PG/ $\overline{RST}$ Timeout Period Adjust Input. PG/ $\overline{RST}$ asserts high after the timeout period when all OUT_ exceed their IN_ referenced threshold. Connect a capacitor from TIMEOUT to GND to set the desired timeout period. Leave TIMEOUT unconnected for the default 200 $\mu$ s delay period.  |
| 13            | —       | 9       | —           | $\overline{MARGIN}$ | Margin Input, Active-Low. Drive $\overline{MARGIN}$ low to enable margin mode (see the <i>Margin</i> section). The $\overline{MARGIN}$ functionality is disabled (returns to normal monitoring mode) after $\overline{MARGIN}$ returns high. $\overline{MARGIN}$ is internally pulled up to ABP through a 10 $\mu$ A current source.                                    |

# Dual-/Triple-Voltage, Power-Supply Sequencers/Supervisors

## Pin Description (continued)

| PIN     |         |         |         | NAME                        | FUNCTION  |
|---------|---------|---------|---------|-----------------------------|---|
| MAX6880 | MAX6881 | MAX6882 | MAX6883 |                             |   |
| 14      | —       | 10      | —       | PG/ $\overline{\text{RST}}$ | Power-Good Output, Open-Drain. PG_ $\overline{\text{RST}}$ asserts high t <sub>TIMEOUT</sub> after all OUT_ voltages exceed the V <sub>TH_PG</sub> thresholds.  |
| 16      | 9       | —       | —       | OUT3                        | Channel 3 Monitored Output Voltage. Connect OUT3 to the source of an n-channel FET. A fault condition activates a 100 $\Omega$ pulldown to ground.  |
| 17      | 10      | —       | —       | GATE3                       | Gate Drive for External n-Channel FET. An internal charge pump boosts GATE3 to V <sub>IN3</sub> + 5V to fully enhance the external n-channel FET when power-up is complete.   |
| 18      | 11      | 11      | 11      | OUT2                        | Channel 2 Monitored Output Voltage. Connect OUT2 to the source of an n-channel FET. A fault condition activates a 100 $\Omega$ pulldown to ground.  |
| 19      | 12      | 12      | 12      | GATE2                       | Gate Drive for External n-Channel FET. An internal charge pump boosts GATE2 to V <sub>IN2</sub> + 5V to fully enhance the external n-channel FET when power-up is complete.   |
| 20      | 13      | 13      | 13      | OUT1                        | Channel 1 Monitored Output Voltage. Connect OUT1 to the source of an n-channel FET. A fault condition activates a 100 $\Omega$ pulldown to ground.  |
| 21      | 14      | 14      | 14      | GATE1                       | Gate Drive for External n-Channel FET. An internal charge pump boosts GATE1 to V <sub>IN1</sub> + 5V to fully enhance the external n-channel FET when power-up is complete.   |
| 22      | 15      | —       | —       | IN3                         | Supply Input Voltage. IN1, IN2, or IN3 must be greater than the internal undervoltage lockout (V <sub>ABP</sub> = 2.7V) to enable the sequencing functionality. Each IN_ input is simultaneously monitored by SET_ inputs to ensure all supplies have stabilized before power-up is enabled. If IN_ is connected to ground or left unconnected and SET_ is above 0.5V, then no sequencing control is performed on that channel. Each IN_ is internally pulled down by a 100k $\Omega$ resistor. |
| 23      | 16      | 15      | 15      | IN2                         |   |
| 24      | 1       | 16      | 16      | IN1                         |   |
| EP      | EP      | EP      | EP      | EP                          | Exposed Paddle. Connect exposed paddle to ground.   |

# Dual-/Triple-Voltage, Power-Supply Sequencers/Supervisors

## Functional Diagram

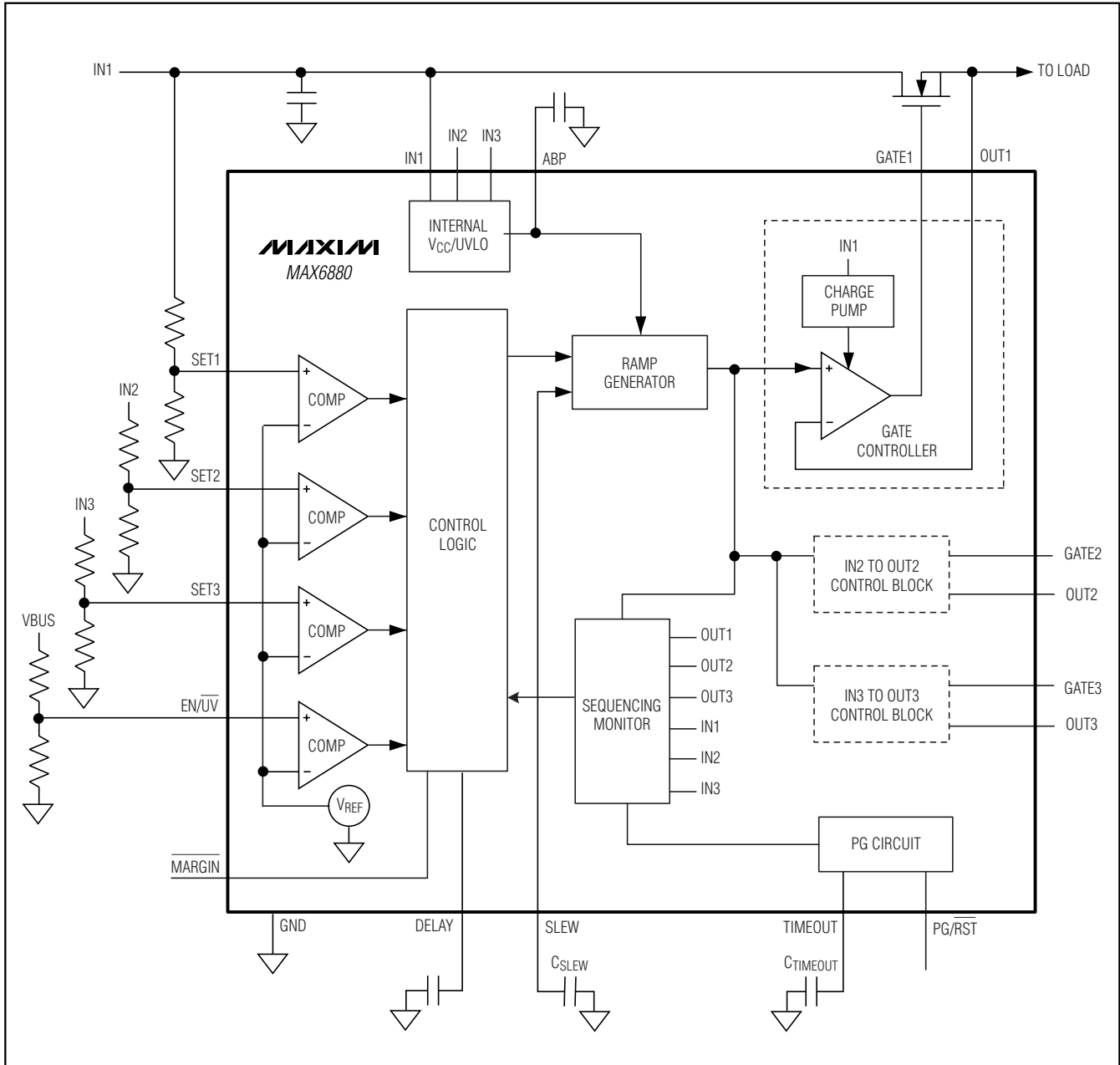

MAX6880-MAX6883

# Dual-/Triple-Voltage, Power-Supply Sequencers/Supervisors

## Detailed Description

The MAX6880–MAX6883 multivoltage power sequencers/supervisors monitor three (MAX6880/MAX6881) and two (MAX6882/MAX6883) system voltages and provide proper power-up and power-down control for systems requiring voltage sequencing. These devices ensure the controlled voltages sequence in the proper order as system power supplies are enabled. The MAX6880–MAX6883 generate all required voltages and timing to control up to three external n-channel pass FETs for the OUT1/OUT2/OUT3 supply voltages.

The MAX6880–MAX6883 feature adjustable undervoltage thresholds for each input supply. When all of the voltages are above the adjusted thresholds these devices turn on the external n-channel MOSFETs to sequence the voltages to the system. The outputs are turned on one after the other, OUT1 first and OUT3 last.

The MAX6880–MAX6883 feature internal charge pumps to fully enhance the external FETs for low-voltage drops at highpass currents. The MAX6880/MAX6882 also feature a power-good output (PG/RST) with a selectable timeout period that can be used for system reset.

The MAX6880–MAX6883 monitor up to three voltages. Devices may be configured to exclude any IN<sub>n</sub>. To disable sequencing operation of any IN<sub>n</sub>, connect the IN<sub>n</sub> to ground (or leave unconnected) and connect SET<sub>n</sub> to a voltage greater than 0.5V. The channel exclusion feature adds more flexibility to the device in a variety of different applications. As an example, the MAX6880 can sequence two voltages using IN1 and IN2 while IN3 is left disabled.

### Powering the MAX6880–MAX6883

These devices derive power from either IN1, IN2, or IN3 voltage inputs (see the *Functional Diagram*). In order to ensure proper operation, at least one of the IN<sub>n</sub> inputs must be at least +2.7V.

The highest input voltage on IN1/IN2/IN3 supplies power to the devices. Internal hysteresis ensures that the supply input that initially powers these devices continues to power the MAX6880–MAX6883 when multiple input voltages are within 100mV (typ) of each other.

### Sequencing

The sequencing operation can be initiated after all input conditions for power-up are met  $V_{EN/UV} > 1.25V$  and all SET<sub>n</sub> inputs are above the internal SET<sub>n</sub> threshold (0.5V). In sequencing mode, the outputs are turned on sequentially, OUT1 first and OUT3 last. Before turning on each channel, a delay period is waited (programmable by connecting a capacitor from DELAY to ground). The power-up phase for each channel ends

when its output voltage exceeds a fixed percentage ( $V_{TH\_PG}$ ) of the corresponding IN<sub>n</sub> voltage. When all channels have exceeded these thresholds, PG/RST asserts high after  $t_{TIMEOUT}$ , indicating a successful sequence.

If there is a fault condition during the initial power-up sequence, the process is aborted.

When powering down, all outputs turn off simultaneously, tracking each other. No reverse power-down sequencing occurs.

The power-supply sequencing operation should be completed within the selected fault timeout period ( $t_{FAULT}$ ) (see Figure 5). The total sequencing time is extended when the devices must vary the control slew rate to allow slow supplies to catch up. If the external FET is too small ( $R_{DS}$  is too high for the selected load current and IN<sub>n</sub> source current), the OUT<sub>n</sub> voltage may never reach the control ramp voltage. For a slew rate of 935V/s, a fault is signaled if all outputs have not stabilized within 22ms. For a slew rate of 93.5V/s, a fault is signaled if sequencing takes too long (more than 219ms).

The fault time period ( $t_{FAULT}$ ) is set through the capacitor at SLEW (CSLEW). Use the following formula to estimate the fault timeout period:

$$t_{FAULT} = 2.191 \times 10^8 \times CSLEW$$

### Autoretry Function

The MAX6880/MAX6881/MAX6882 feature autoretry modes to power-on again after a fault condition has been detected (see the *Typical Operating Characteristics*).

When a fault is detected, for a period of  $t_{RETRY}$ , GATE<sub>n</sub> remains off and the 100Ω pull-downs are turned on. After the  $t_{RETRY}$  period, the device waits  $t_{DELAY}$  and retry sequencing if all power-up conditions are met (see Figure 5). These include all  $V_{SET\_n} > 0.5V$ ,  $EN/UV > V_{EN\_R}$ , and OUT<sub>n</sub> voltages  $< V_{TH\_PL}$ . The autoretry period  $t_{RETRY}$  is a function of CSLEW (see Table 1).

### Power-Up and Power-Down

During power-up, OUT<sub>n</sub> is forced to follow the internal reference ramp voltage by an internal loop that controls the GATE<sub>n</sub> of the external MOSFET. This phase must be completed within the adjustable fault timeout period ( $t_{FAULT}$ ); otherwise, the part forces a shutdown on all GATE<sub>n</sub>.

Once the power-up is completed, a power-down phase can be initiated by forcing  $V_{EN/UV}$  below  $V_{EN\_F}$ . The reference voltage ramp ramps down at the capacitor-adjusted slew rate. The control-loop comparators monitor each OUT<sub>n</sub> voltage with respect to the common

# Dual-/Triple-Voltage, Power-Supply Sequencers/Supervisors

reference ramp voltage. During ramp down, if an OUT\_ voltage is greater than the reference ramp voltage by more than  $V_{TRK}$ , the control loop dynamically stops the control ramp voltage from decreasing until the slow OUT\_ voltage catches up. If an OUT\_ voltage is greater or less than the reference ramp voltage by more than  $V_{TRK\_F}$ , a fault is signaled and the fast-shutdown mode is initiated. In fast-shutdown mode, a 100Ω pull-down resistor is connected from OUT\_ to GND to quickly discharge capacitance at OUT\_, and GATE\_ is pulled low with a strong IGDS current (see Figure 3).

Figure 4 shows the aborted sequencing mode. When  $\overline{EN/UV}$  goes low before  $t_{TIMEOUT}$  expires, all the outputs go low, and the device goes into fast shutdown.

### Internal Pulldown

To ensure that the OUT\_ voltages are not held high by a large output capacitance after a fault has occurred, there is a 100Ω internal pull-down at OUT\_. The pull-down ensures that all OUT\_ voltages are below  $V_{TH\_PL}$  (referenced to GND) before power-up cycling is initiated. The internal pull-down also ensures a fast discharge of the output capacitor during fast shutdown and fault modes. The pull-downs are not present during normal operation.

### Stability Comment

No external compensation is required for sequencing or slew-rate control.

### Inputs

#### IN1/IN2/IN3

The highest voltage on IN1, IN2, or IN3 supplies power to the device. The undervoltage threshold for each IN\_ supply is set with an external resistor-divider from each IN\_ to SET\_ to ground. To disable sequencing on any IN\_, connect IN\_ to ground (or leave unconnected) and connect SET\_ to a voltage greater than 0.5V.

#### Undervoltage Lockout Threshold Inputs (SET\_)

The MAX6880/MAX6881 feature three and the MAX6882/MAX6883 feature two externally adjustable IN\_ undervoltage lockout thresholds (SET1/SET2/SET3). The 0.5V SET\_ threshold enables monitoring IN\_ voltages as low as 0.5V. The undervoltage threshold for each IN\_ supply is set with an external resistor-divider from each IN\_ to SET\_ to ground (see Figure 6). All SET\_ inputs must be above the internal SET\_ threshold (0.5V) to enable sequencing functionality. Use the following formula to set the UVLO threshold:

$$V_{IN\_} = V_{TH} (R1 + R2) / R2$$

where  $V_{IN\_}$  is the undervoltage lockout threshold and  $V_{TH}$  is the 500mV SET threshold.

#### Margin Input ( $\overline{MARGIN}$ ) (MAX6880/MAX6882)

$\overline{MARGIN}$  allows system-level testing while power supplies are below the normal ranges as adjusted by the SET\_ inputs. Drive  $\overline{MARGIN}$  low before varying system voltages below the adjusted thresholds to avoid signaling an error. The state of  $\overline{PG/RST}$  does not change while  $\overline{MARGIN}$  is low.  $\overline{PG/RST}$  and all monitoring functions are disabled while  $\overline{MARGIN}$  is low.  $\overline{MARGIN}$  makes it possible to vary the supplies without a need to adjust the thresholds to prevent sequencer alerts. Drive  $\overline{MARGIN}$  high or leave it unconnected for normal operating mode.

#### Slew-Rate Control Input (SLEW)

The reference ramp voltage slew rate during any controlled power-up/down phase can be programmed in the 90V/s to 950V/s range by connecting a capacitor ( $C_{SLEW}$ ) from SLEW to ground. Use the following formula to calculate the typical slew rate:

$$\text{Slew Rate} = (9.35 \times 10^{-8}) / C_{SLEW}$$

where slew rate is in V/s and  $C_{SLEW}$  is in farads.

The capacitor at  $C_{SLEW}$  also sets the retry timeout period ( $t_{RETRY}$ ), see Table 1.

For example, if  $C_{SLEW} = 100\text{pF}$ , we have  $t_{RETRY} = 350\text{ms}$ ,  $t_{FAULT} = 21.91\text{ms}$ , slew rate = 935V/s. For example, if  $C_{SLEW} = 1\text{nF}$ , we have  $t_{RETRY} = 3.5\text{s}$ , slew rate = 93.5V/s.

$C_{SLEW}$  is the capacitor on SLEW pad, and must be large enough so the parasitic PC board capacitance is negligible.  $C_{SLEW}$  should be in the range of  $100\text{pF} < C_{SLEW} < 1\text{nF}$ .

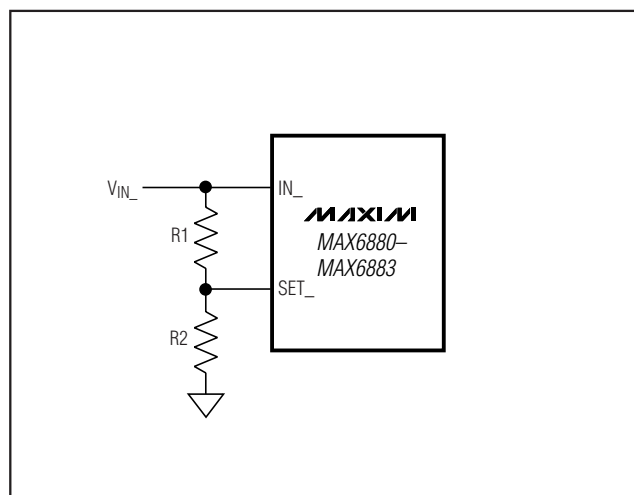

Figure 6. Setting the Undervoltage (UVLO) Thresholds

# Dual-/Triple-Voltage, Power-Supply Sequencers/Supervisors

**Table 1. C<sub>SLEW</sub> Timing Formulas**

| TIME PERIOD        | FORMULAS                               |
|--------------------|--|
| Slew Rate          | $(9.35 \times 10^{-8}) / C_{SLEW}$     |
| t <sub>RETRY</sub> | $3.506 \times 10^{-9} \times C_{SLEW}$ |
| t <sub>FAULT</sub> | $2.191 \times 10^{-8} \times C_{SLEW}$ |

### Limiting Inrush Current

The capacitor (C<sub>SLEW</sub>) at SLEW to ground, controls the OUT\_ slew rate, thus controlling the inrush current required to charge the load capacitor at OUT\_. Using the programmed slew rate, limit the inrush current by using the following formula:

$$I_{INRUSH} = C_{OUT} \times SR$$

where I<sub>INRUSH</sub> is in amperes, C<sub>OUT</sub> is in farads, and SR is in V/s.

### Delay Time Input (DELAY)

To adjust the desired delay period (t<sub>DELAY</sub>) before sequencing is enabled, connect a capacitor (C<sub>DELAY</sub>) between DELAY to ground (see Figures 2 to 5). The selected delay time is also enforced when EN/UV rises from low to high when all the input voltages are present. Use the following formula to calculate the delay time:

$$t_{DELAY} = 200\mu s + (500k\Omega \times C_{DELAY})$$

where t<sub>DELAY</sub> is in  $\mu s$  and C<sub>DELAY</sub> is in farads. Leave DELAY unconnected for the default 200 $\mu s$  delay.

### Timeout Period Input (TIMEOUT) (MAX6880/MAX6882)

These devices feature a PG/RST timeout period. Connect a capacitor (C<sub>TIMEOUT</sub>) from TIMEOUT to ground to program the PG/RST timeout period. After all OUT\_ outputs exceed their IN\_ referenced thresholds (V<sub>TH\_PG</sub>), PG/RST remains low for the selected timeout period t<sub>TIMEOUT</sub> (see Figure 3).

$$t_{TIMEOUT} = 200\mu s + (500k\Omega \times C_{TIMEOUT})$$

where t<sub>TIMEOUT</sub> is in  $\mu s$  and C<sub>TIMEOUT</sub> is in farads. Leave TIMEOUT unconnected for the default 200 $\mu s$  timeout delay.

### Logic-Enable Input (EN/UV)

Drive logic EN/UV input above V<sub>EN\_R</sub> to initiate voltage sequencing during power-up operation. Drive logic EN/UV below V<sub>EN\_F</sub> to initiate tracking power-down operation. Connect EN/UV to an external resistor-divider network to set the external undervoltage lockout threshold.

### ABP Input (MAX6880/MAX6882)

ABP powers the analog circuitry. Bypass ABP to GND with a 1 $\mu F$  ceramic capacitor installed as close to the device as possible. ABP takes the highest voltage of IN\_. Do not use ABP to provide power to external circuitry. ABP maintains the device supply voltage during rapid power-down conditions.

### OUT1/OUT2/OUT3

The MAX6880/MAX6881 monitor three OUT\_ and the MAX6882/MAX6883 monitor two OUT\_ outputs to control the sequencing performance. After the internal supply (ABP) exceeds the minimum voltage (2.7V) requirements, EN/UV > V<sub>EN\_R</sub>, and IN1/IN2/IN3 are all greater than their adjusted SET\_ thresholds, OUT1/OUT2/OUT3 begin to sequence.

During fault conditions, an internal pulldown resistor (100 $\Omega$ ) on OUT\_ is enabled to help discharge load capacitance (100 $\Omega$  is connected for fast power-down control).

### Outputs

#### GATE\_

The MAX6880-MAX6883 feature up to three GATE\_ outputs to drive up to three external n-channel FET gates. The following conditions must be met before GATE\_ begins enhancing the external n-channel FET\_:

- 1) All SET\_ inputs (SET1/SET2/SET3) are above their 0.5V thresholds.
- 2) At least one IN\_ input is above the minimum operating voltage (2.7V).
- 3) EN/UV > 1.25V.

At power-up mode, GATE\_ voltages are enhanced by control loops so all OUT\_ voltages sequence at a capacitor-adjusted slew rate. Each GATE\_ is internally pulled up to 5V above its relative IN\_ voltage to fully enhance the external n-channel FET when power-up is complete.

### Power-Good Output (PG/RST) (MAX6880/MAX6882)

The MAX6880/MAX6882 include a power-good (PG/RST) output. PG/RST is an open-drain output and requires an external pullup resistor.

All the OUT\_ outputs must exceed their IN\_ referenced thresholds (IN\_ x V<sub>TH\_PG</sub>) for the selected reset timeout period t<sub>TIMEOUT</sub> (see the *TIMEOUT Period Input* section) before PG/RST asserts high. PG/RST stays low for the selected reset timeout period (t<sub>TIMEOUT</sub>) after all the OUT\_ voltages exceed their IN\_ referenced thresholds. PG/RST goes low when V<sub>SET\_</sub> < V<sub>TH</sub> or V<sub>EN/UV</sub> < V<sub>EN\_R</sub> (see Figure 2).

# Dual-/Triple-Voltage, Power-Supply Sequencers/Supervisors

MAX6880-MAX6883

## Applications Information

### MOSFET Selection

The external pass MOSFET is connected in series with the sequenced power-supply source. Since the load current and the MOSFET drain-to-source impedance ( $R_{DS}$ ) determine the voltage drop, the on characteristics of the MOSFET affect the load supply accuracy. The MAX6880-MAX6883 fully enhance the external MOSFET out of its linear range to ensure the lowest drain-to-source on-impedance. For highest supply accuracy/lowest voltage drop, select a MOSFET with an appropriate drain-to-source on-impedance with a gate-to-source bias of 4.5V to 6.0V.

### Layout and Bypassing

For better noise immunity, bypass each of the  $IN_{-}$  inputs to GND with 0.1 $\mu$ F capacitors installed as close to the device as possible. Bypass ABP to GND with a 1 $\mu$ F capacitor installed as close to the device as possible. ABP is an internally generated voltage and must not be used to supply power to external circuitry.

## Selector Guide

| PART    | CHANNEL | TIMEOUT SELECTABLE | PG/ $\overline{RST}$ | $\overline{MARGIN}$ | PG THRESHOLD VOLTAGE (%) |
|---------|---------|--------------------|----------------------|---------------------|--------------------------|
| MAX6880 | 3       | Yes                | Yes                  | Yes                 | 92.5                     |
| MAX6881 | 3       | No                 | No                   | No                  | —                        |
| MAX6882 | 2       | Yes                | Yes                  | Yes                 | 92.5                     |
| MAX6883 | 2       | No                 | No                   | No                  | —                        |

## Chip Information

PROCESS: BICMOS

# Dual-/Triple-Voltage, Power-Supply Sequencers/Supervisors

## Typical Application Circuit

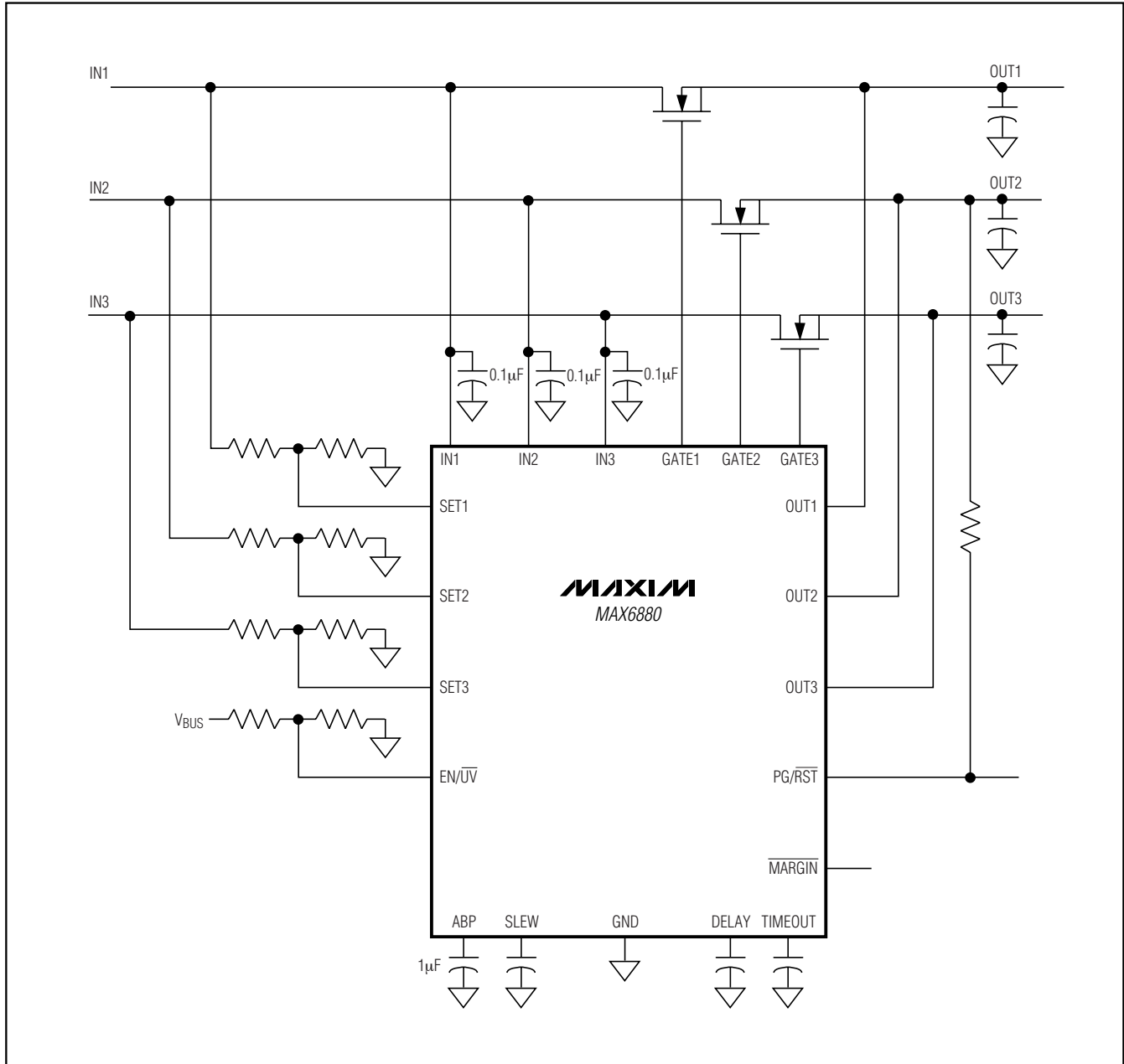



# Dual-/Triple-Voltage, Power-Supply Sequencers/Supervisors

## Pin Configurations (continued)

**MAX6880-MAX6883**

TOP VIEW

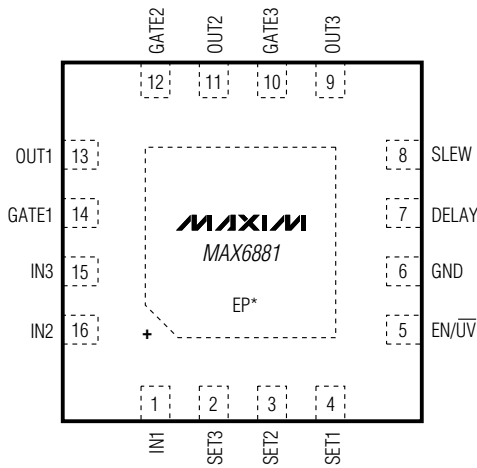

4mm x 4mm THIN QFN

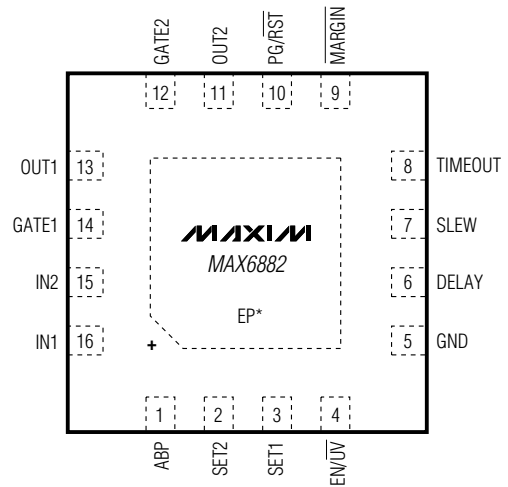

4mm x 4mm THIN QFN

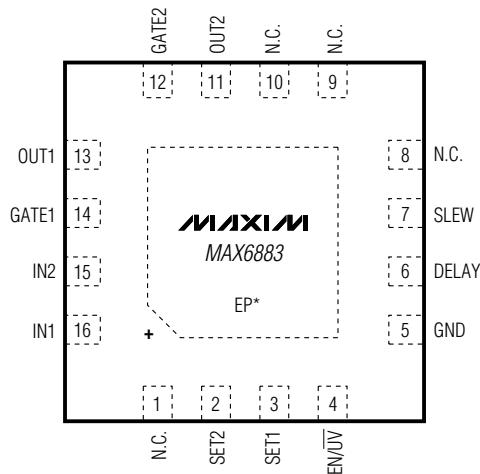

4mm x 4mm THIN QFN

\*EXPOSED PADDLE CONNECTED TO GND.

# Dual-/Triple-Voltage, Power-Supply Sequencers/Supervisors

## Package Information

(The package drawing(s) in this data sheet may not reflect the most current specifications. For the latest package outline information, go to [www.maxim-ic.com/packages](http://www.maxim-ic.com/packages).)

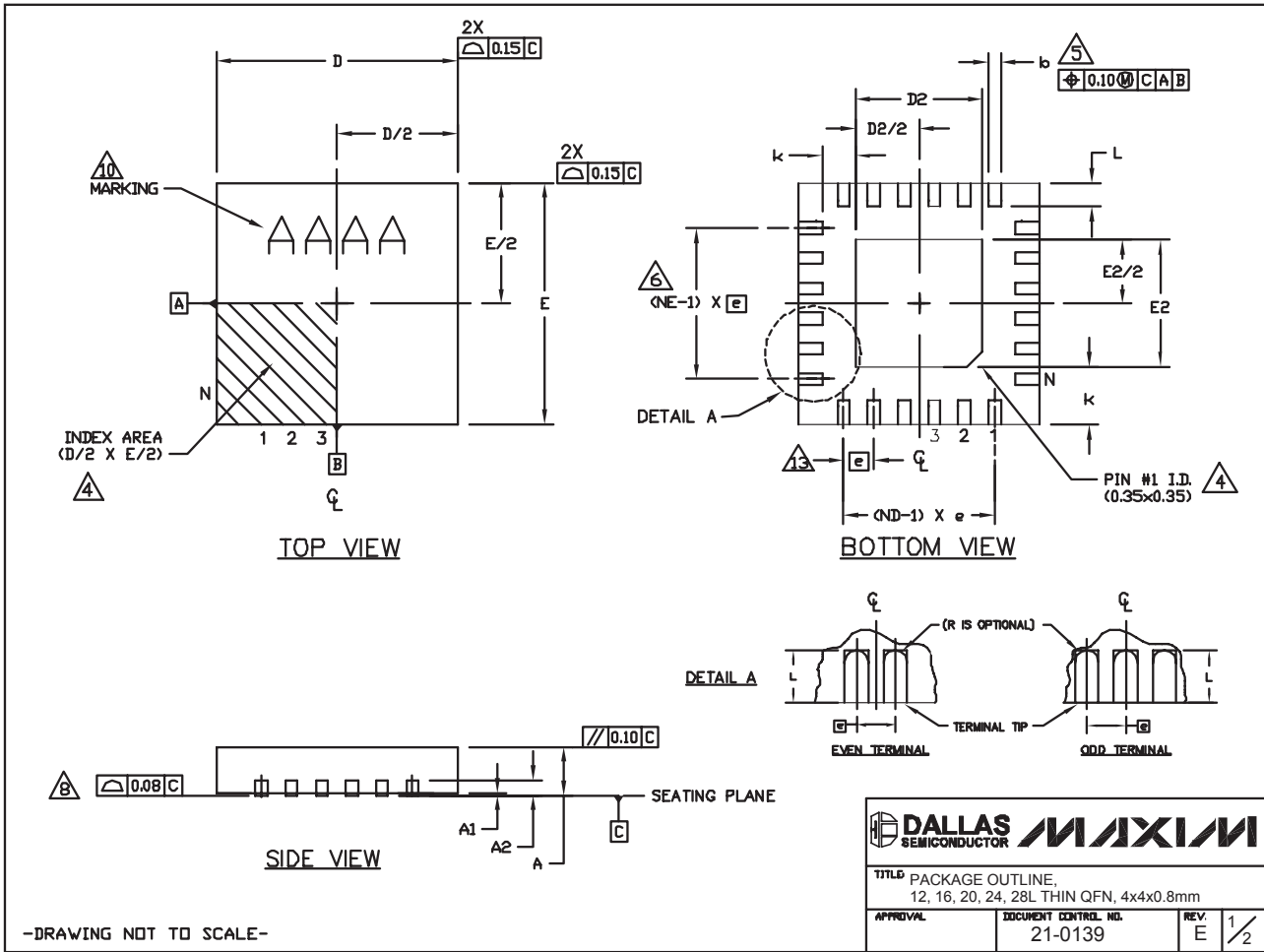

-DRAWING NOT TO SCALE-

# Dual-/Triple-Voltage, Power-Supply Sequencers/Supervisors

## Package Information (continued)

(The package drawing(s) in this data sheet may not reflect the most current specifications. For the latest package outline information, go to [www.maxim-ic.com/packages](http://www.maxim-ic.com/packages).)

MAX6880-MAX6883

| COMMON DIMENSIONS |           |      |      |           |      |      |           |      |      |           |      |      |           |      |      |
|-------------------|-----------|------|------|-----------|------|------|-----------|------|------|-----------|------|------|-----------|------|------|
| PKG               | 12L 4x4   |      |      | 16L 4x4   |      |      | 20L 4x4   |      |      | 24L 4x4   |      |      | 28L 4x4   |      |      |
| REF.              | MIN.      | NOM. | MAX. | MIN.      | NOM. | MAX. | MIN.      | NOM. | MAX. | MIN.      | NOM. | MAX. | MIN.      | NOM. | MAX. |
| A                 | 0.70      | 0.75 | 0.80 | 0.70      | 0.75 | 0.80 | 0.70      | 0.75 | 0.80 | 0.70      | 0.75 | 0.80 | 0.70      | 0.75 | 0.80 |
| A1                | 0.0       | 0.02 | 0.05 | 0.0       | 0.02 | 0.05 | 0.0       | 0.02 | 0.05 | 0.0       | 0.02 | 0.05 | 0.0       | 0.02 | 0.05 |
| A2                | 0.20 REF  |      |      | 0.20 REF  |      |      | 0.20 REF  |      |      | 0.20 REF  |      |      | 0.20 REF  |      |      |
| b                 | 0.25      | 0.30 | 0.35 | 0.25      | 0.30 | 0.35 | 0.20      | 0.25 | 0.30 | 0.18      | 0.23 | 0.30 | 0.15      | 0.20 | 0.25 |
| D                 | 3.90      | 4.00 | 4.10 | 3.90      | 4.00 | 4.10 | 3.90      | 4.00 | 4.10 | 3.90      | 4.00 | 4.10 | 3.90      | 4.00 | 4.10 |
| E                 | 3.90      | 4.00 | 4.10 | 3.90      | 4.00 | 4.10 | 3.90      | 4.00 | 4.10 | 3.90      | 4.00 | 4.10 | 3.90      | 4.00 | 4.10 |
| e                 | 0.80 BSC. |      |      | 0.65 BSC. |      |      | 0.50 BSC. |      |      | 0.50 BSC. |      |      | 0.40 BSC. |      |      |
| k                 | 0.25      | -    | -    | 0.25      | -    | -    | 0.25      | -    | -    | 0.25      | -    | -    | 0.25      | -    | -    |
| L                 | 0.45      | 0.53 | 0.63 | 0.45      | 0.53 | 0.63 | 0.45      | 0.53 | 0.63 | 0.30      | 0.40 | 0.50 | 0.30      | 0.40 | 0.50 |
| N                 | 12        |      |      | 16        |      |      | 20        |      |      | 24        |      |      | 28        |      |      |
| ND                | 3         |      |      | 4         |      |      | 5         |      |      | 6         |      |      | 7         |      |      |
| NE                | 3         |      |      | 4         |      |      | 5         |      |      | 6         |      |      | 7         |      |      |
| JeDEC Var.        | VGG3      |      |      | VGGC      |      |      | WGGD-1    |      |      | WGGD-2    |      |      | VGGE      |      |      |

| EXPOSED PAD VARIATIONS |      |      |      |      |      |      |                    |
|------------------------|------|------|------|------|------|------|--------------------|
| PKG. CODES             | D2   |      |      | E2   |      |      | DOWN BONDS ALLOWED |
|                        | MIN. | NOM. | MAX. | MIN. | NOM. | MAX. |                    |
| T1244-3                | 1.95 | 2.10 | 2.25 | 1.95 | 2.10 | 2.25 | YES                |
| T1244-4                | 1.95 | 2.10 | 2.25 | 1.95 | 2.10 | 2.25 | NO                 |
| T1644-3                | 1.95 | 2.10 | 2.25 | 1.95 | 2.10 | 2.25 | YES                |
| T1644-4                | 1.95 | 2.10 | 2.25 | 1.95 | 2.10 | 2.25 | NO                 |
| T2044-2                | 1.95 | 2.10 | 2.25 | 1.95 | 2.10 | 2.25 | YES                |
| T2044-3                | 1.95 | 2.10 | 2.25 | 1.95 | 2.10 | 2.25 | NO                 |
| T2444-2                | 1.95 | 2.10 | 2.25 | 1.95 | 2.10 | 2.25 | YES                |
| T2444-3                | 2.45 | 2.60 | 2.63 | 2.45 | 2.60 | 2.63 | YES                |
| T2444-4                | 2.45 | 2.60 | 2.63 | 2.45 | 2.60 | 2.63 | NO                 |
| T2844-1                | 2.50 | 2.60 | 2.70 | 2.50 | 2.60 | 2.70 | NO                 |

**NOTES:**

- DIMENSIONING & TOLERANCING CONFORM TO ASME Y14.5M-1994.
- ALL DIMENSIONS ARE IN MILLIMETERS. ANGLES ARE IN DEGREES.
- N IS THE TOTAL NUMBER OF TERMINALS.
- THE TERMINAL #1 IDENTIFIER AND TERMINAL NUMBERING CONVENTION SHALL CONFORM TO JEDEC 95-1 SPP-012. DETAILS OF TERMINAL #1 IDENTIFIER ARE OPTIONAL, BUT MUST BE LOCATED WITHIN THE ZONE INDICATED. THE TERMINAL #1 IDENTIFIER MAY BE EITHER A MOLD OR MARKED FEATURE.
- DIMENSION b APPLIES TO METALLIZED TERMINAL AND IS MEASURED BETWEEN 0.25 mm AND 0.30 mm FROM TERMINAL TIP.
- ND AND NE REFER TO THE NUMBER OF TERMINALS ON EACH D AND E SIDE RESPECTIVELY.
- DEPOPULATION IS POSSIBLE IN A SYMMETRICAL FASHION.
- COPLANARITY APPLIES TO THE EXPOSED HEAT SINK SLUG AS WELL AS THE TERMINALS.
- DRAWING CONFORMS TO JEDEC MO220, EXCEPT FOR T2444-3, T2444-4 AND T2844-1.
- MARKING IS FOR PACKAGE ORIENTATION REFERENCE ONLY.
- COPLANARITY SHALL NOT EXCEED 0.08mm
- WARPAGE SHALL NOT EXCEED 0.10mm
- LEAD CENTERLINES TO BE AT TRUE POSITION AS DEFINED BY BASIC DIMENSION "e", ±0.05.
- NUMBER OF LEADS SHOWN ARE FOR REFERENCE ONLY

-DRAWING NOT TO SCALE-

|  |                      |       |
|--|----------------------|-------|
|  |                      |       |
| TITLED PACKAGE OUTLINE,<br>12, 16, 20, 24, 28L THIN QFN, 4x4x0.8mm |                      |       |
| APPROVAL   | DOCUMENT CONTROL NO. | REV.  |
|  | 21-0139              | E 2/2 |

Maxim cannot assume responsibility for use of any circuitry other than circuitry entirely embodied in a Maxim product. No circuit patent licenses are implied. Maxim reserves the right to change the circuitry and specifications without notice at any time.

Maxim Integrated Products, 120 San Gabriel Drive, Sunnyvale, CA 94086 408-737-7600 19