

MECHANICAL DATA

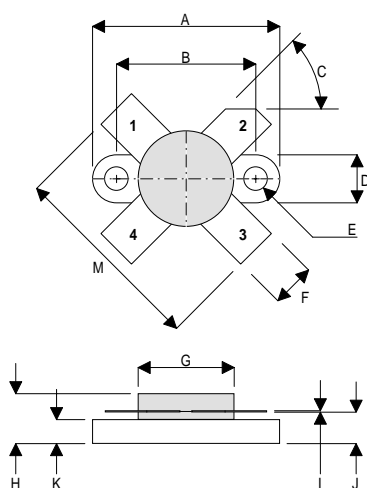

DM

PIN 1 SOURCE PIN 2 DRAIN
 PIN 3 SOURCE PIN 4 GATE

DIM	mm	Tol.	Inches	Tol.
A	24.76	0.13	0.975	0.005
B	18.42	0.13	0.725	0.005
C	45°	5°	45°	5°
D	6.35	0.13	0.25	0.005
E	3.17 Dia.	0.13	0.125 Dia.	0.005
F	5.71	0.13	0.225	0.005
G	12.7 Dia.	0.13	0.500 Dia.	0.005
H	6.60	REF	0.260	REF
I	0.13	0.02	0.005	0.001
J	4.32	0.13	0.170	0.005
K	3.17	0.13	0.125	0.005
M	26.16	0.25	1.03	0.010

**GOLD METALLISED
 MULTI-PURPOSE SILICON
 DMOS RF FET
 150W – 28V – 175MHz
 SINGLE ENDED**

FEATURES

- SIMPLIFIED AMPLIFIER DESIGN
- SUITABLE FOR BROAD BAND APPLICATIONS
- LOW C_{rss}
- SIMPLE BIAS CIRCUITS
- LOW NOISE
- HIGH GAIN – 13 dB MINIMUM

APPLICATIONS

- HF/VHF/UHF COMMUNICATIONS
 from 1 MHz to 200 MHz

ABSOLUTE MAXIMUM RATINGS ($T_{case} = 25^{\circ}C$ unless otherwise stated)

P_D	Power Dissipation	220W
BV_{DSS}	Drain – Source Breakdown Voltage	70V
BV_{GSS}	Gate – Source Breakdown Voltage	$\pm 20V$
$I_{D(sat)}$	Drain Current	30A
T_{stg}	Storage Temperature	-65 to $150^{\circ}C$
T_j	Maximum Operating Junction Temperature	$200^{\circ}C$

ELECTRICAL CHARACTERISTICS (T_{case} = 25°C unless otherwise stated)

Parameter	Test Conditions	Min.	Typ.	Max.	Unit
B _V DSS Drain–Source Breakdown Voltage	V _{GS} = 0 I _D = 100mA	70			V
I _D DSS Zero Gate Voltage Drain Current	V _{DS} = 28V V _{GS} = 0			6	mA
I _G DSS Gate Leakage Current	V _{GS} = 20V V _{DS} = 0			1	μA
V _{GS(th)} Gate Threshold Voltage*	I _D = 10mA V _{DS} = V _{GS}	1		7	V
g _{fs} Forward Transconductance*	V _{DS} = 10V I _D = 6A	4.8			S
G _{PS} Common Source Power Gain	P _O = 150W	13			dB
η Drain Efficiency	V _{DS} = 28V I _{DQ} = 0.6A	50			%
VSWR Load Mismatch Tolerance	f = 175MHz	20:1			—
C _{iss} Input Capacitance	V _{DS} = 0V V _{GS} = -5V f = 1MHz			360	pF
C _{oss} Output Capacitance	V _{DS} = 28V V _{GS} = 0 f = 1MHz			180	pF
C _{rss} Reverse Transfer Capacitance	V _{DS} = 28V V _{GS} = 0 f = 1MHz			15	pF

* Pulse Test: Pulse Duration = 300 μs , Duty Cycle ≤ 2%

HAZARDOUS MATERIAL WARNING

The ceramic portion of the device between leads and metal flange is beryllium oxide. Beryllium oxide dust is highly toxic and care must be taken during handling and mounting to avoid damage to this area.

THESE DEVICES MUST NEVER BE THROWN AWAY WITH GENERAL INDUSTRIAL OR DOMESTIC WASTE.

THERMAL DATA

R _{THj-case}	Thermal Resistance Junction – Case	Max. 0.8°C / W
-----------------------	------------------------------------	----------------

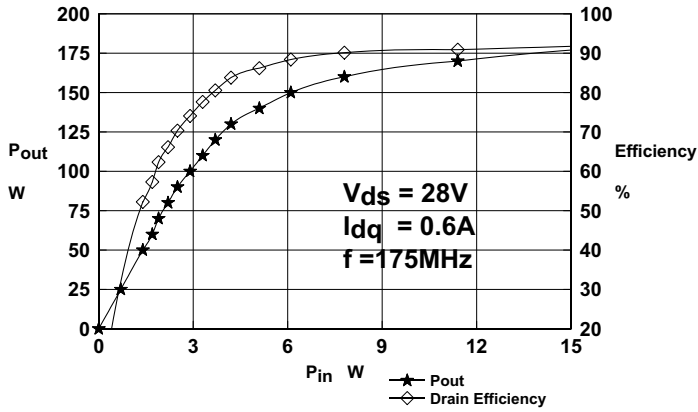

Figure 1
Power Out & Efficiency vs Power Input

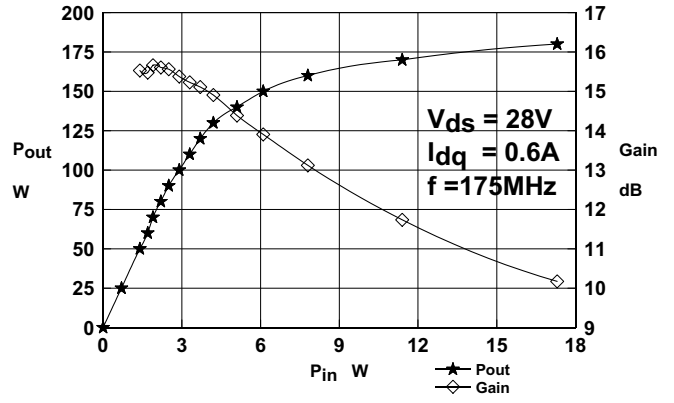

Figure 2
Power Out & Gain vs. Power Input

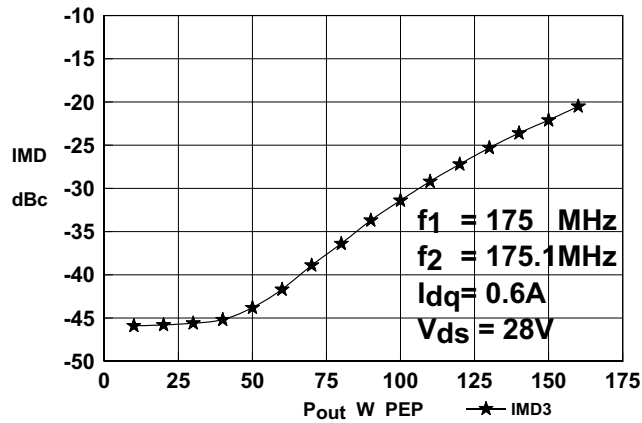
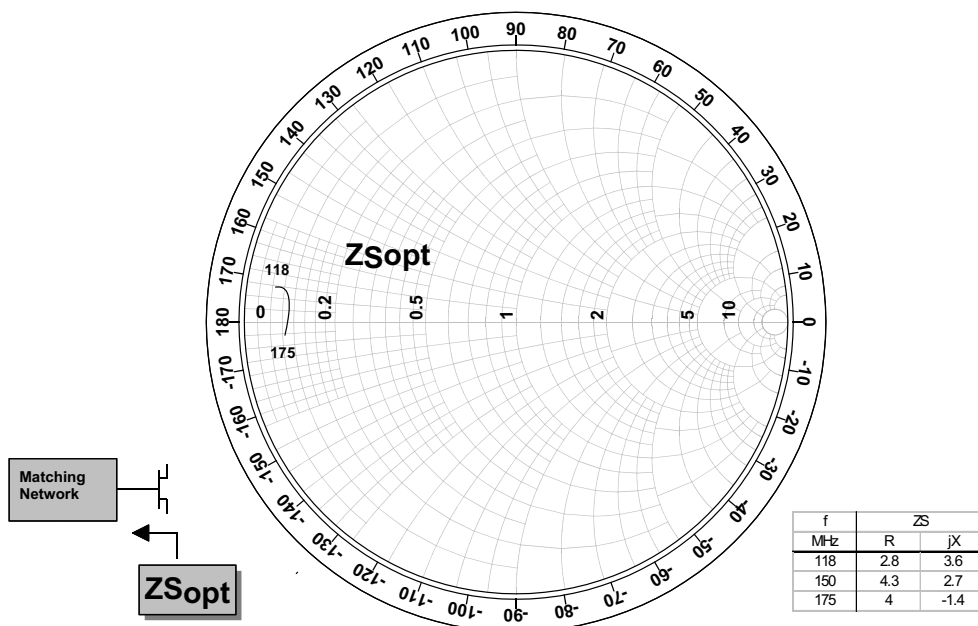
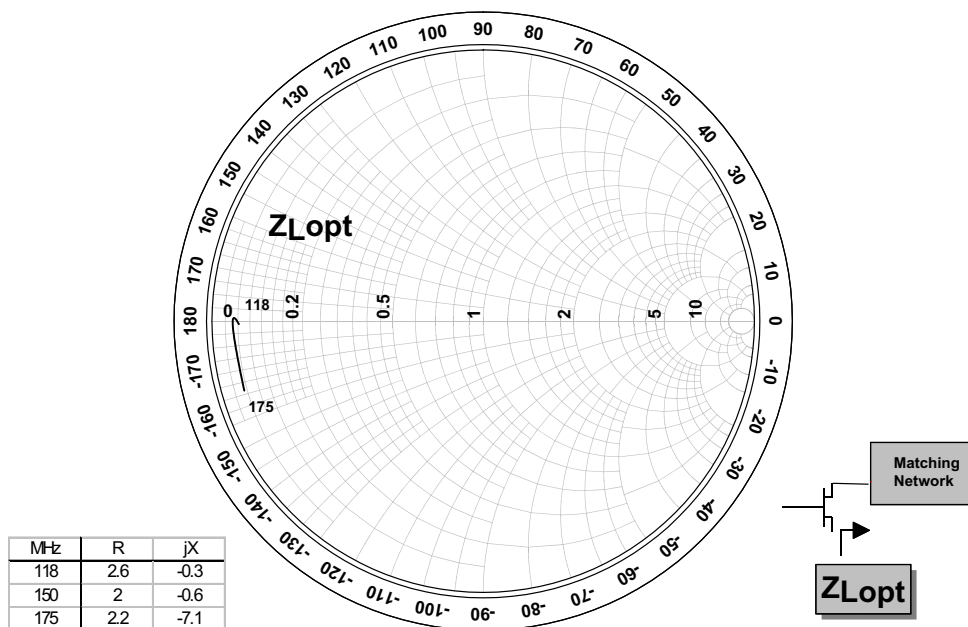

Figure 3
IMD Versus Power Output

Typical S Parameters

! Vds=28V Idq=0.6A
MHz S MA R 50

!Freq !MHz	S11		S21		S12		S22	
	mag	ang	mag	ang	mag	ang	mag	ang
50	0.83	-167.4	7.42	93.3	0.009	26.5	0.79	-167
100	0.89	-169.4	3.56	64.1	0.008	44.1	0.82	-163.7
150	0.93	-169.3	2.05	45.2	0.01	75.4	0.87	-164.7
200	0.95	-170.1	1.23	34.2	0.016	88.2	0.91	-166.3
250	0.96	-170.2	0.85	26	0.023	89.1	0.94	-167.7
300	0.97	-169.7	0.62	22.6	0.03	90.1	0.96	-169
350	0.97	-170.4	0.44	15.2	0.035	86.1	0.96	-169.8
400	0.98	-169.3	0.35	17.8	0.043	85.2	0.97	-170.5
450	0.98	-169	0.27	15.9	0.046	84	0.98	-171.7
500	0.99	-168.5	0.23	19.6	0.053	83.1	0.99	-171.4



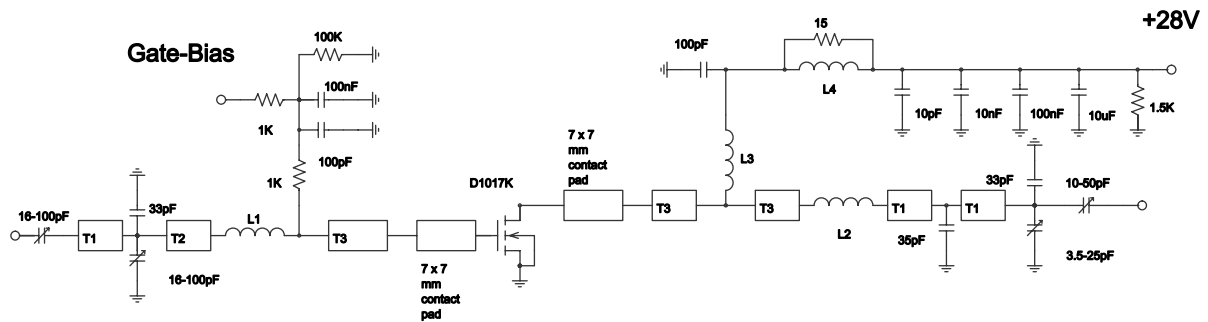

175MHz TEST FIXTURE

Substrate 1.6mm PTFE/glass, $\epsilon_r=2.5$

All microstrip lines $W = 5\text{mm}$

T1,T2 7.5mm

T3 6mm

L1 Hairpin loop 18swg 10mm high, 6.5mm gap

L2 Hairpin loop 5mm wide ribbon, 7mm high, 3.5mm gap

L3 9 turns 19swg enamelled copper wire, 6mm i.d.

L4 12 turns 19swg enamelled copper wire on Fair-Rite FT82 ferrite core