

## OUTLINE

The R5324D Series are CMOS-based multi positive voltage regulator ICs with high output voltage accuracy, low supply current, low noise, low dropout and high ripple rejection. The R5324D Series contain three voltage regulators. Each of these voltage regulators in the R5324D Series consists of a voltage reference unit, an error amplifier, resistors for setting output voltage, a short current limit circuit, a chip enable circuit, and so on.

The chip enable function contributes to prolong battery life. Further, regulators in the R5324D Series are with low dropout voltage, excellent load transient response and line transient response, thus the R5324D series are very suitable for the power supply for hand-held communication equipment.

Since the package for these ICs is SON-8, high density mounting of the ICs on boards is possible.

## FEATURES

- Ultra-Low Supply Current .....Typ.  $90\mu\text{A}$ : VR1, Typ.  $90\mu\text{A}$ : VR2, Typ.  $90\mu\text{A}$ : VR3
- Low Standby Current .....Typ.  $0.1\mu\text{A}$
- Low Dropout Voltage .....Typ. 0.23V (VR1) 0.22V(VR2) 0.15V (VR3)  
 $I_{\text{OUT}}=200\text{mA}$ : VR1, 150mA: VR2, 100mA: VR3  
(ex. for 3.0V Output Type)
- High Ripple Rejection .....Typ. 70dB ( $f=1\text{kHz}$ ), 65dB ( $f=10\text{kHz}$ )
- High Output Voltage Accuracy ..... $\pm 2.0\%$
- Excellent Load Transient Response and Line Transient Response
- Small Package .....SON-8
- Ceramic Capacitor Recommended for Output ..... $1.0\mu\text{F}$  or more

## APPLICATIONS

- Power source for cellular phones and portable communication equipment.
- Power source for electrical appliances such as cameras, VCRs.
- Power source for battery-powered equipment.

### BLOCK DIAGRAMS

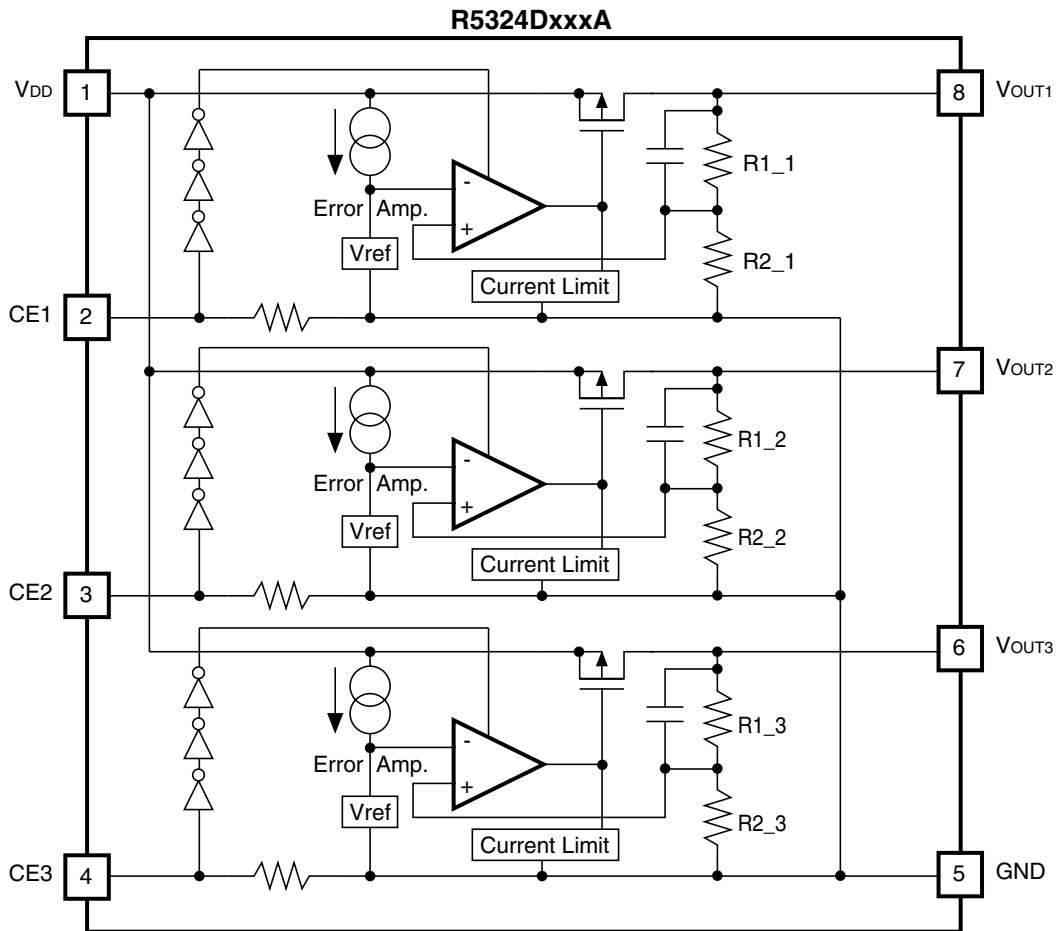

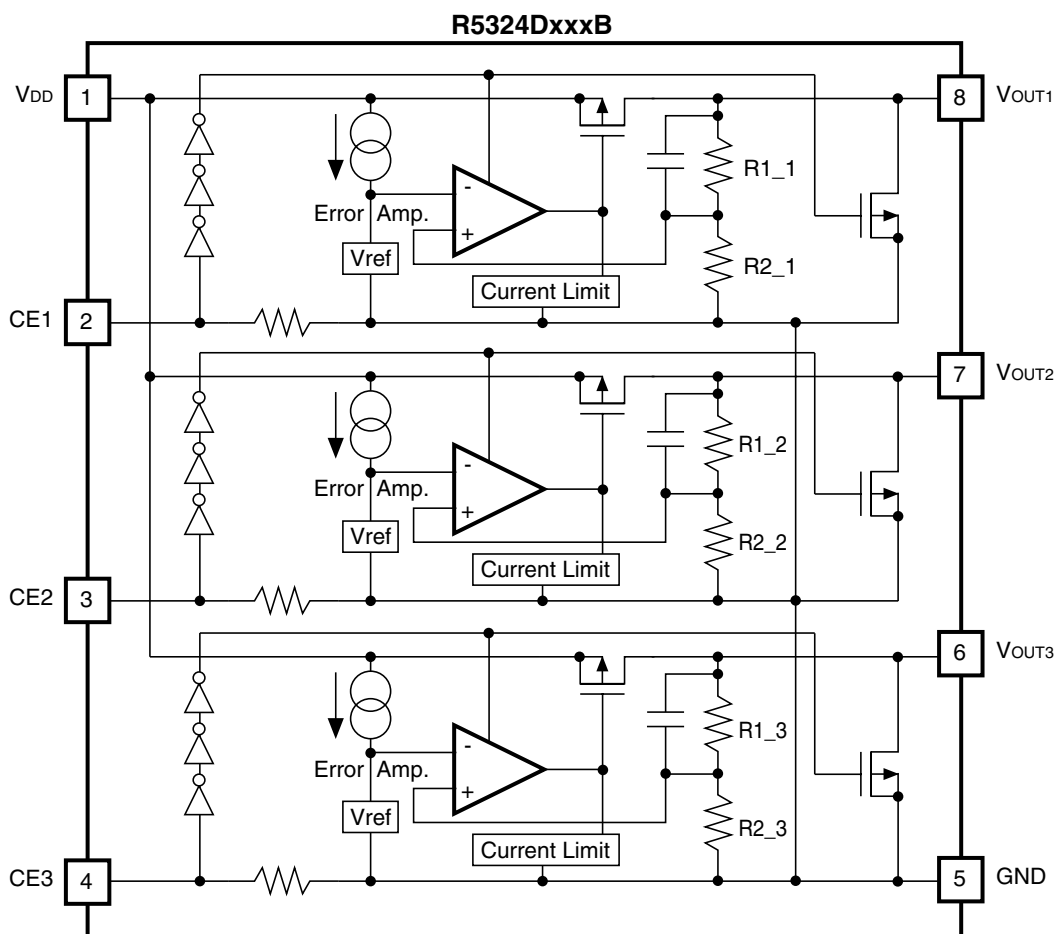

## SELECTION GUIDE

The selection can be made with designating the part number as shown below:

R5324Dxxx-TR      ←Part Number  
                   ↑ ↑ ↑  
                   a b c

Code	Descriptions
a	Serial Number for Voltage setting from 001
b	Alphabetical Code for Mask Versions A: Standard B: With auto discharge function at off state
c	Designation of Taping Type (TR is described as standard.)

## PIN CONFIGURATION

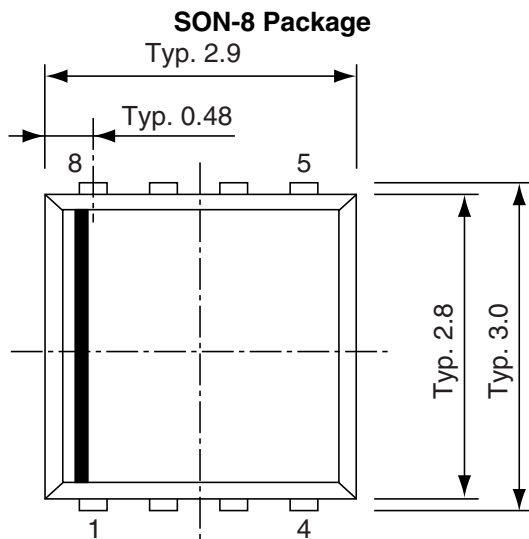

## PIN DESCRIPTION

Pin No.	Symbol	Descriptions
1	V <sub>DD</sub>	Input Pin
2	CE1	Chip Enable Pin 1
3	CE2	Chip Enable Pin 2
4	CE3	Chip Enable Pin 3
5	GND	Ground Pin
6	V <sub>OUT3</sub>	Output Pin 3
7	V <sub>OUT2</sub>	Output Pin 2
8	V <sub>OUT1</sub>	Output Pin 1

**ABSOLUTE MAXIMUM RATINGS**

Symbol	Item	Rating	Unit
$V_{IN}$	Input Voltage	6.5	V
CE	Input Voltage (CE Pin)	$-0.3 \sim V_{IN} + 0.3$	V
$V_{OUT}$	Output Voltage	$-0.3 \sim V_{IN} + 0.3$	V
$I_{OUT1}$	Output Current ( $V_{OUT1}$ )	230	mA
$I_{OUT2}$	Output Current ( $V_{OUT2}$ )	180	mA
$I_{OUT3}$	Output Current ( $V_{OUT3}$ )	180	mA
$P_D$	Power Dissipation	300	mW
$T_{opt}$	Operating Temperature Range	$-40 \sim 85$	$^{\circ}\text{C}$
$T_{stg}$	Storage Temperature Range	$-55 \sim 125$	$^{\circ}\text{C}$

## ELECTRICAL CHARACTERISTICS

## • R5324DxxxA/B

VR1

T<sub>opt</sub>=25°C

Symbol	Item	Conditions	Min.	Typ.	Max.	Unit
V <sub>OUT</sub>	Output Voltage	V <sub>IN</sub> -V <sub>OUT</sub> =1.0V 1mA≤I <sub>OUT</sub> ≤30mA	×0.98		×1.02	V
I <sub>OUT</sub>	Output Current	V <sub>IN</sub> -V <sub>OUT</sub> =1.0V	200			mA
ΔV <sub>OUT</sub> /ΔI <sub>OUT</sub>	Load Regulation	V <sub>IN</sub> -V <sub>OUT</sub> =1.0V 1mA≤I <sub>OUT</sub> ≤200mA		25	50	mV
V <sub>DIF</sub>	Dropout Voltage	Refer to Electrical Characteristic by Output Voltage (VR1)				
I <sub>SS</sub>	Supply Current	V <sub>IN</sub> -V <sub>OUT</sub> =1.0V		90	140	μA
I <sub>standby</sub>	Supply Current (Standby)	V <sub>IN</sub> -V <sub>OUT</sub> =1.0V, V <sub>CE</sub> =GND		0.1	1.0	μA
ΔV <sub>OUT</sub> /ΔV <sub>IN</sub>	Line Regulation	V <sub>OUT</sub> +0.5V≤V <sub>IN</sub> ≤6.0V I <sub>OUT</sub> =30mA (V <sub>OUT</sub> ≥2.0V: 2.2V≤V <sub>IN</sub> ≤6.0V)		0.02	0.10	%/V
RR	Ripple Rejection	f=1kHz f=10kHz f=10kHz (V <sub>OUT</sub> ≥2.5V) sinusoidal Ripple 0.5Vp-p V <sub>IN</sub> -V <sub>OUT</sub> =1.0V, I <sub>OUT</sub> =30mA V <sub>OUT</sub> ≤1.7V V <sub>IN</sub> -V <sub>OUT</sub> =1.2V		70 65 60		dB
V <sub>IN</sub>	Input Voltage		2.0		6.0	V
ΔV <sub>OUT</sub> /ΔT	Output Voltage Temperature Coefficient	I <sub>OUT</sub> =30mA -40°≤T <sub>opt</sub> ≤85°C		±100		ppm/°C
I <sub>LIM</sub>	Short Current Limit	V <sub>OUT</sub> =0V		40		mA
R <sub>PD</sub>	CE Pull-down Resistance		0.7	2.0	5.0	MΩ
V <sub>CEH</sub>	CE Input Voltage "H"		1.5		V <sub>IN</sub>	V
V <sub>CEL</sub>	CE Input Voltage "L"		0.0		0.3	V
en	Output Noise	BW=10Hz~100kHz		30		μV <sub>rms</sub>
R <sub>LOW</sub>	On Resistance of Nch Tr. for Auto-discharge (Applied to B version)	V <sub>CE</sub> =0V		50		Ω

- ELECTRICAL CHARACTERISTICS by OUTPUT VOLTAGE (VR1)

 $T_{opt}=25^{\circ}\text{C}$ 

Output Voltage $V_{OUT}$ (V)	Dropout Voltage		
	$V_{DIF}$ (V)		
	Condition	Typ.	Max.
$V_{OUT}=1.5$	$I_{OUT}=200\text{mA}$	0.36	0.65
$V_{OUT}=1.6$		0.34	0.58
$V_{OUT}=1.7$		0.33	0.56
$1.8 \leq V_{OUT} \leq 2.0$		0.31	0.53
$2.1 \leq V_{OUT} \leq 2.7$		0.28	0.46
$2.8 \leq V_{OUT} \leq 4.0$		0.23	0.35

VR2

Topt=25°C

Symbol	Item	Conditions	Min.	Typ.	Max.	Unit
V <sub>OUT</sub>	Output Voltage	V <sub>IN</sub> -V <sub>OUT</sub> =1.0V 1mA<I <sub>OUT</sub> ≤30mA	×0.98		×1.02	V
I <sub>OUT</sub>	Output Current	V <sub>IN</sub> -V <sub>OUT</sub> =1.0V	150			mA
ΔV <sub>OUT</sub> /ΔI <sub>OUT</sub>	Load Regulation	V <sub>IN</sub> -V <sub>OUT</sub> =1.0V 1mA≤I <sub>OUT</sub> ≤150mA		15	40	mV
V <sub>DIF</sub>	Dropout Voltage	Refer to Electrical Characteristics by Output Voltage (VR2)				
I <sub>SS</sub>	Supply Current	V <sub>IN</sub> -V <sub>OUT</sub> =1.0V		90	120	μA
I <sub>standby</sub>	Supply Current (Standby)	V <sub>IN</sub> -V <sub>OUT</sub> =1.0V, V <sub>CE</sub> =GND		0.1	1.0	μA
ΔV <sub>OUT</sub> /ΔV <sub>IN</sub>	Line Regulation	V <sub>OUT</sub> +0.5V≤V <sub>IN</sub> ≤6V I <sub>OUT</sub> =30mA (V <sub>OUT</sub> ≤1.6V: 2.2V≤V <sub>IN</sub> ≤6V)		0.02	0.10	%/V
RR	Ripple Rejection	f=1kHz f=10kHz f=10kHz (V <sub>OUT</sub> ≥2.5V) sinusoidal Ripple 0.5Vp-p V <sub>IN</sub> -V <sub>OUT</sub> =1.0V, I <sub>OUT</sub> =30mA (V <sub>OUT</sub> ≤1.7V V <sub>IN</sub> -V <sub>OUT</sub> =1.2V)		70 65 60		dB
V <sub>IN</sub>	Input Voltage		2.0		6.0	V
ΔV <sub>OUT</sub> /ΔT	Output Voltage Temperature Coefficient	I <sub>OUT</sub> =30mA -40°C≤Topt≤85°C		±100		ppm/°C
I <sub>LM</sub>	Short Current Limit	V <sub>OUT</sub> =0V		40		mA
R <sub>PD</sub>	CE Pull-down Resistance		0.7	2.0	5.0	MΩ
V <sub>CEH</sub>	CE Input Voltage "H"		1.5		V <sub>IN</sub>	V
V <sub>CEL</sub>	CE Input Voltage "L"		0.00		0.30	V
en	Output Noise	BW=10Hz~100kHz		30		μVrms
R <sub>LOW</sub>	On Resistance of Nch Tr. for Auto-discharge (Applied to B version)	V <sub>CE</sub> =0V		50		Ω



- ELECTRICAL CHARACTERISTICS by OUTPUT VOLTAGE (VR2)

T<sub>opt</sub>=25°C

Output Voltage V <sub>OUT</sub> (V)	Dropout Voltage		
	V <sub>DIF</sub> (V)		
	Condition	Typ.	Max.
V <sub>OUT</sub> =1.5	I <sub>OUT</sub> =150mA	0.34	0.60
V <sub>OUT</sub> =1.6		0.32	0.56
V <sub>OUT</sub> =1.7		0.31	0.53
1.8≤V <sub>OUT</sub> ≤2.0		0.29	0.50
2.1≤V <sub>OUT</sub> ≤2.7		0.26	0.44
2.8≤V <sub>OUT</sub> ≤4.0		0.22	0.33

VR3

T<sub>opt</sub>=25°C

Symbol	Item	Conditions	Min.	Typ.	Max.	Unit
V <sub>OUT</sub>	Output Voltage	V <sub>IN</sub> -V <sub>OUT</sub> =1.0V 1mA≤I <sub>OUT</sub> ≤30mA	×0.98		×1.02	V
I <sub>OUT</sub>	Output Current	V <sub>IN</sub> -V <sub>OUT</sub> =1.0V	100			mA
ΔV <sub>OUT</sub> /ΔI <sub>OUT</sub>	Load Regulation	V <sub>IN</sub> -V <sub>OUT</sub> =1.0V 1mA≤I <sub>OUT</sub> ≤100mA		8	20	mV
V <sub>DIF</sub>	Dropout Voltage	Refer to Electrical Characteristics by Dropout Voltage (VR3)				
I <sub>SS</sub>	Supply Current	V <sub>IN</sub> -V <sub>OUT</sub> =1.0V		90	120	μA
I <sub>standby</sub>	Supply Current (Standby)	V <sub>IN</sub> -V <sub>OUT</sub> =1.0V, V <sub>CE</sub> =GND		0.1	1.0	μA
ΔV <sub>OUT</sub> /ΔV <sub>IN</sub>	Line Regulation	V <sub>OUT</sub> +0.5V≤V <sub>IN</sub> ≤6V I <sub>OUT</sub> =30mA		0.02	0.10	%/V
RR	Ripple Rejection	f=1kHz f=10kHz f=10kHz (V <sub>OUT</sub> ≥2.5V) sinusoidal Ripple 0.5Vp-p V <sub>IN</sub> -V <sub>OUT</sub> =1.0V, I <sub>OUT</sub> =30mA (V <sub>OUT</sub> ≤1.7V V <sub>IN</sub> -V <sub>OUT</sub> =1.2V)		70 65 60		dB
V <sub>IN</sub>	Input Voltage		2.0		6.0	V
ΔV <sub>OUT</sub> /ΔT	Output Voltage Temperature Coefficient	I <sub>OUT</sub> =30mA -40°C≤T <sub>opt</sub> ≤85°C		±100		ppm/°C
I <sub>LIM</sub>	Short Current Limit	V <sub>OUT</sub> =0V		40		mA
R <sub>PD</sub>	CE Pull-down Resistance		0.7	2.0	5.0	MΩ
V <sub>CEH</sub>	CE Input Voltage "H"		1.5		V <sub>IN</sub>	V
V <sub>CEL</sub>	CE Input Voltage "L"		0.0		0.3	V
en	Output Noise	BW=10Hz~100kHz		30		μV <sub>rms</sub>
R <sub>LOW</sub>	On Resistance of Nch Tr. for Auto-discharge (Applied to B version)	V <sub>CE</sub> =0V		50		Ω

• ELECTRICAL CHARACTERISTICS by OUTPUT VOLTAGE (VR3)

$T_{opt}=25^{\circ}\text{C}$

Output Voltage $V_{OUT}$ (V)	Dropout Voltage		
	$V_{DIF}$ (V)		
	Condition	Typ.	Max.
$V_{OUT}=1.5$	$I_{OUT}=100\text{mA}$	0.24	0.44
$V_{OUT}=1.6$		0.22	0.40
$V_{OUT}=1.7$		0.21	0.38
$1.8 \leq V_{OUT} \leq 2.0$		0.20	0.37
$2.1 \leq V_{OUT} \leq 2.7$		0.18	0.33
$2.8 \leq V_{OUT} \leq 4.0$		0.15	0.25

## OPERATION

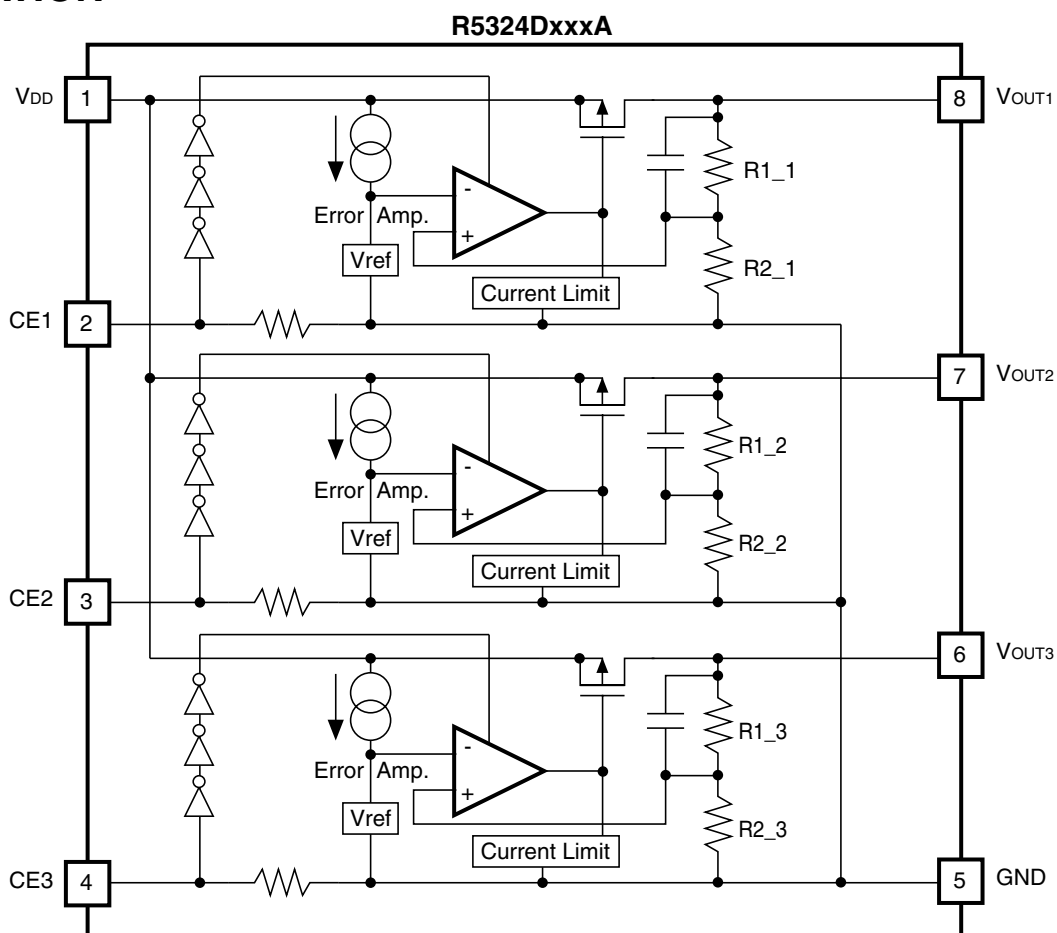

Fluctuation of each regulator's output voltage, or  $V_{OUT1, 2, 3}$  is detected individually. Then it is put back to an error amplifier through feedback resistors, or  $R1_1, R2_1, R1_2, R2_2, R1_3, R2_3$  and compared with a reference voltage and compensated for the result and make a constant voltage.

In each regulator, short protection is made with a current limit circuit and stand-by mode is available by a chip enable circuit.

### TEST CIRCUITS

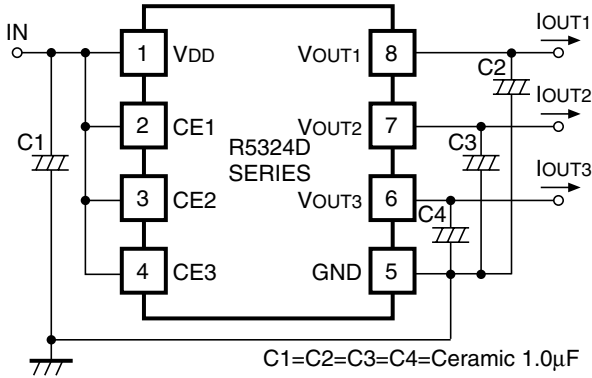

Standard Test Circuit

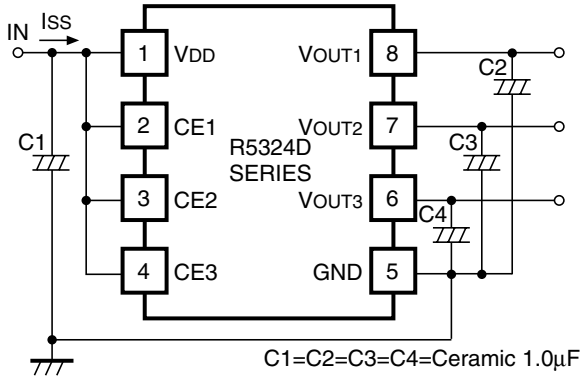

Supply Current Test Circuit

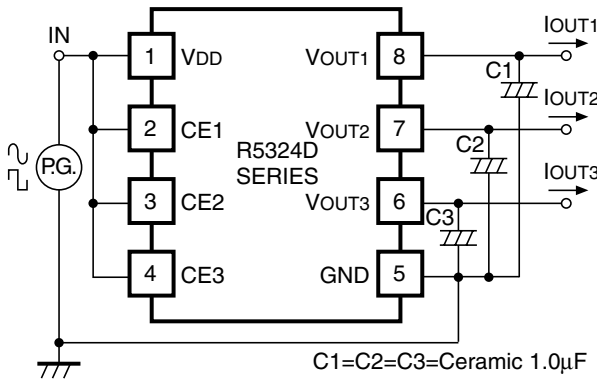

Ripple Rejection, Input Transient Response Test Circuit

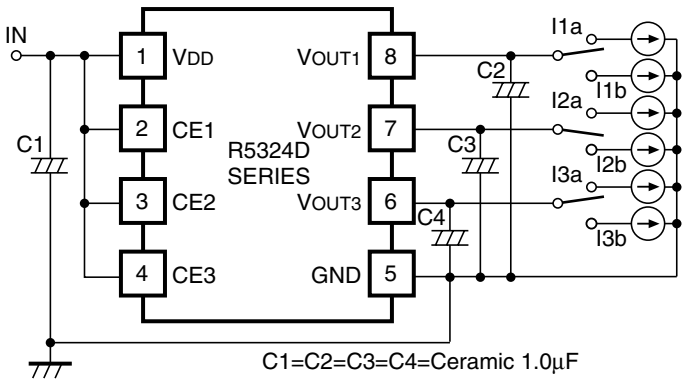

Load Transient Response Test Circuit

### TYPICAL CHARACTERISTICS

1) Output Voltage vs. Output Current (T<sub>opt</sub>=25°C)

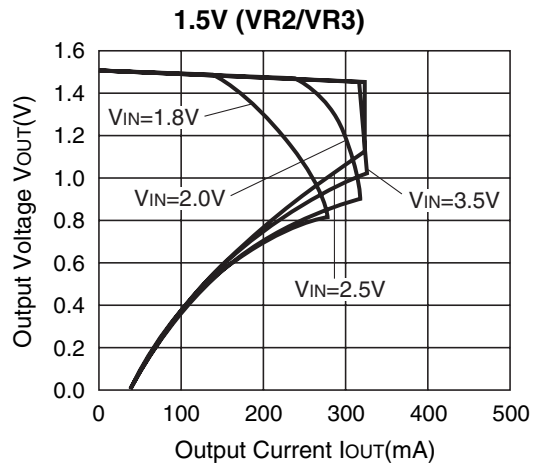
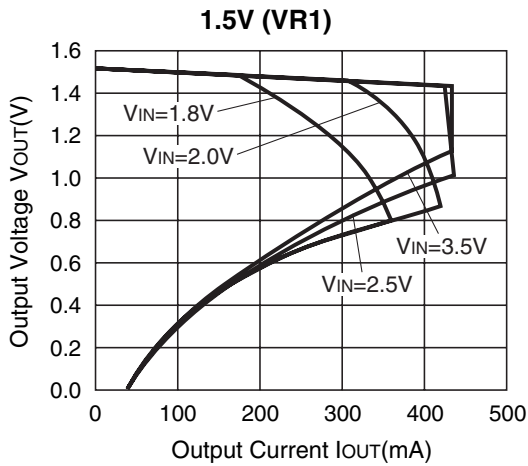

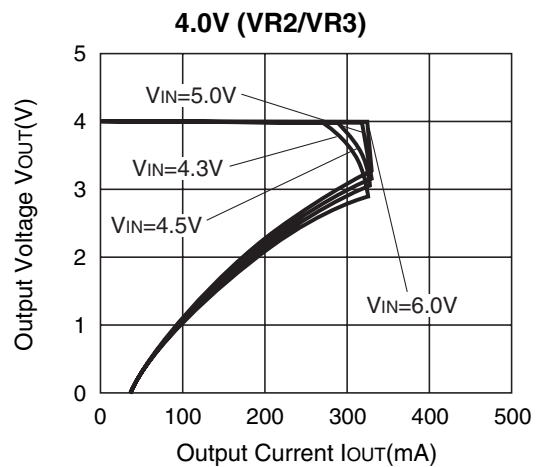
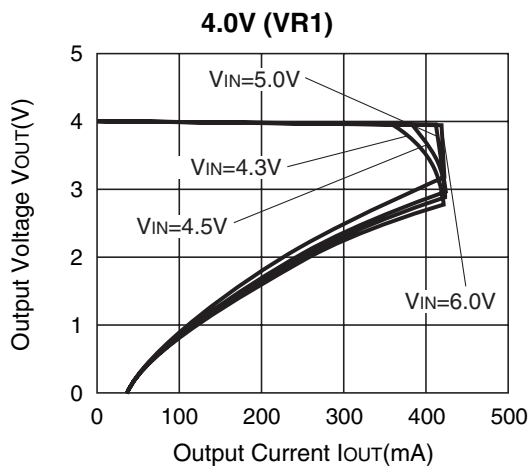
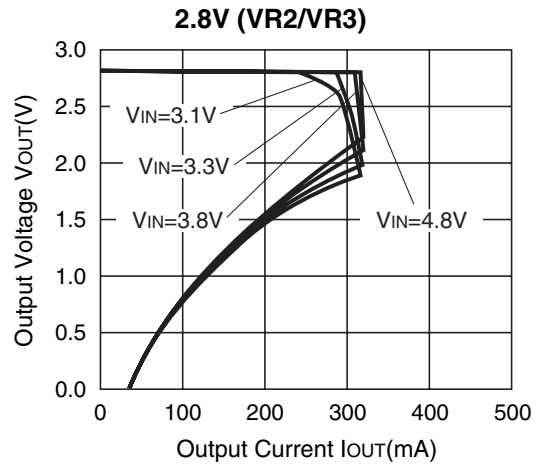
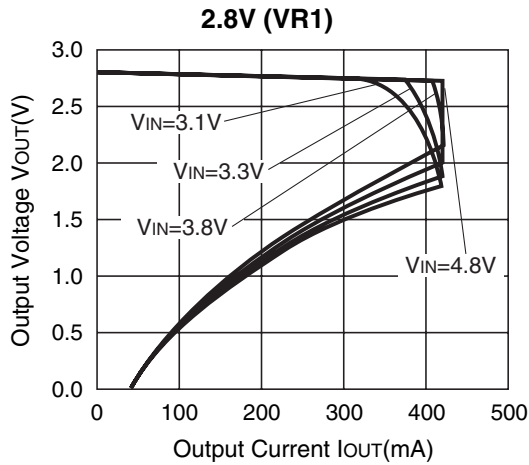

2) Output Voltage vs. Input Voltage ( $T_{opt}=25^{\circ}C$ )

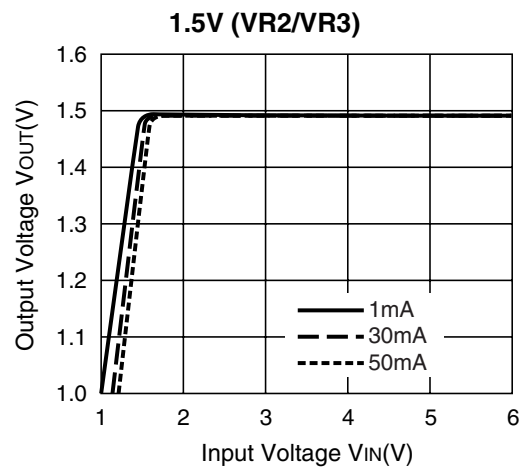
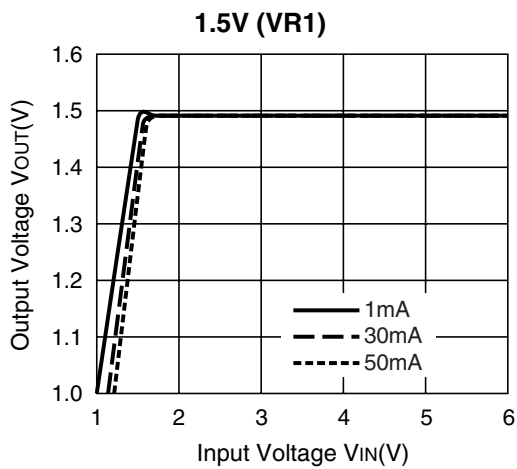

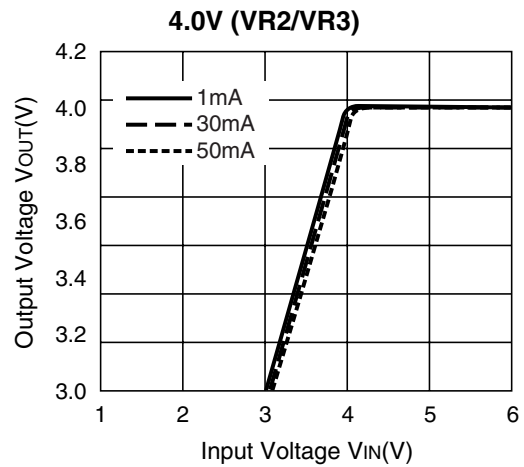
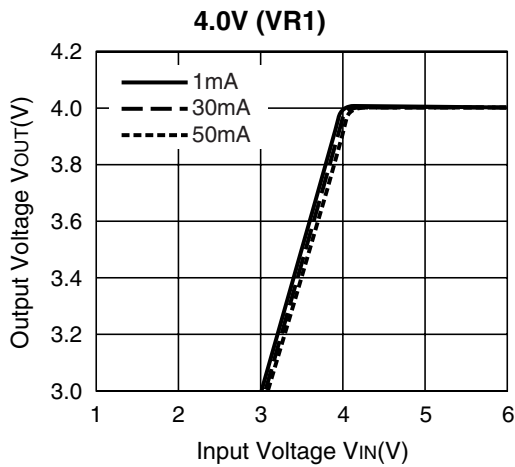
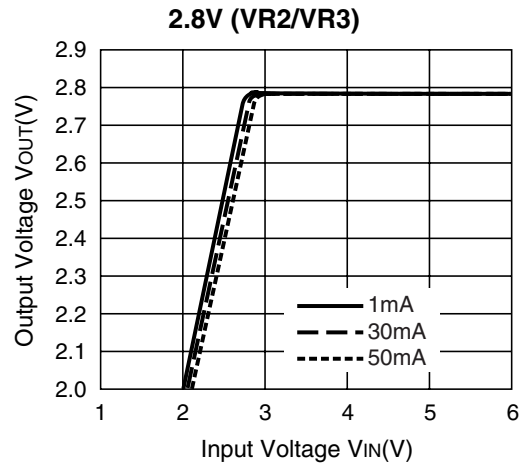
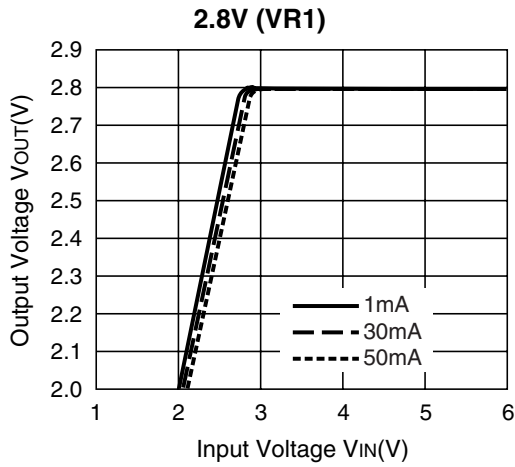

3) Dropout Voltage vs. Output Current

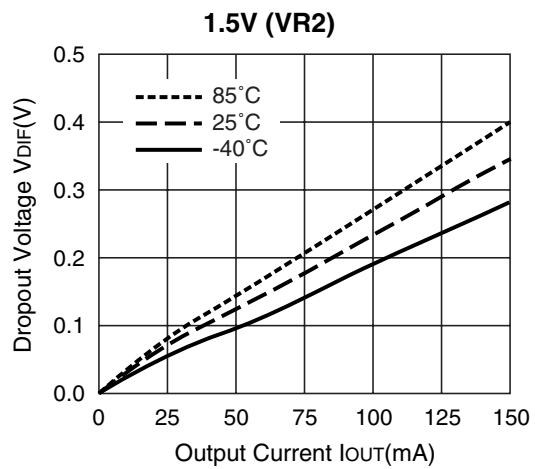
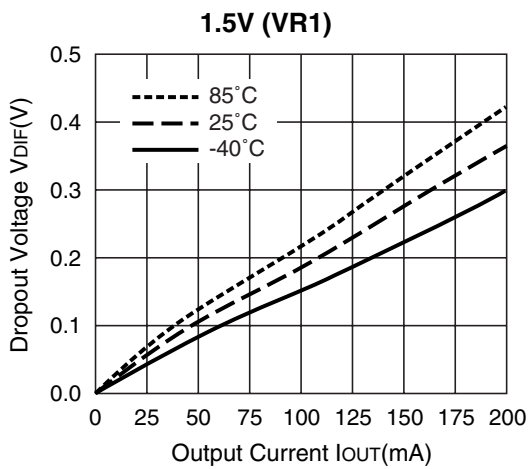

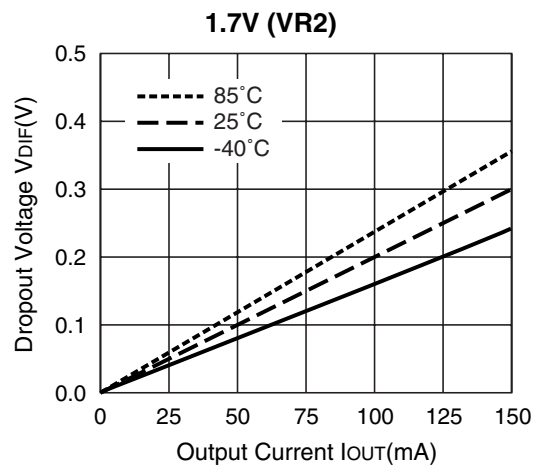
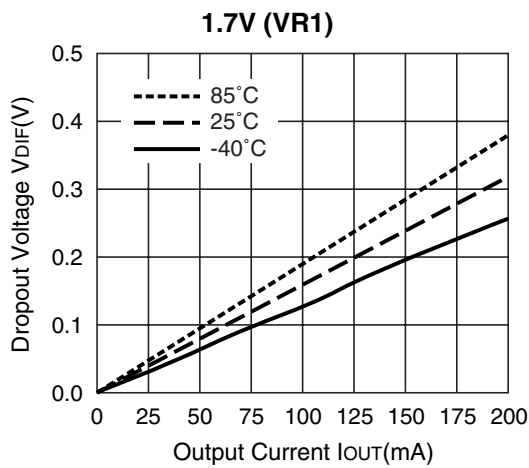
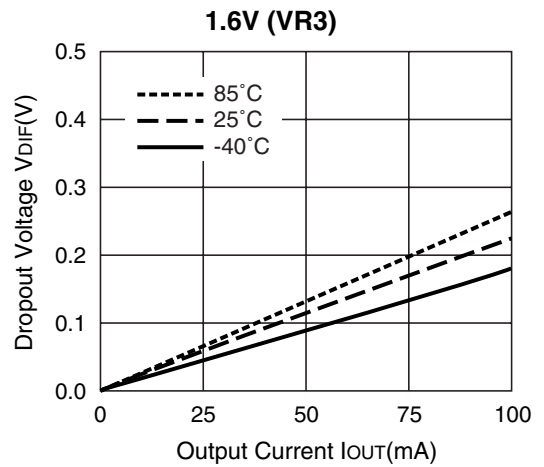
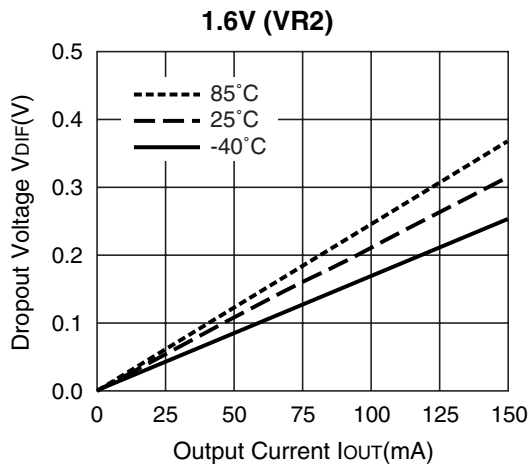
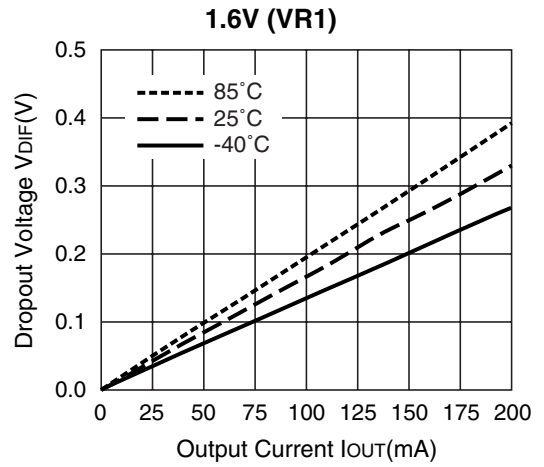
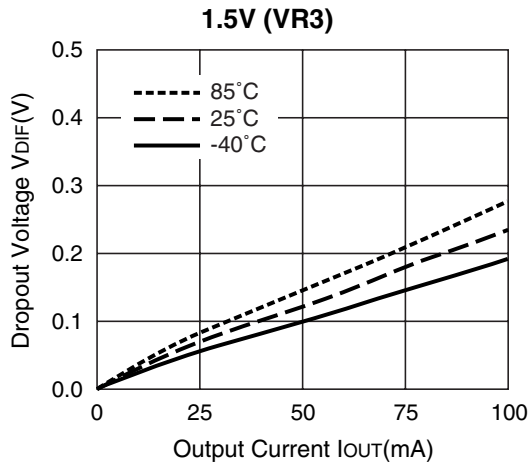

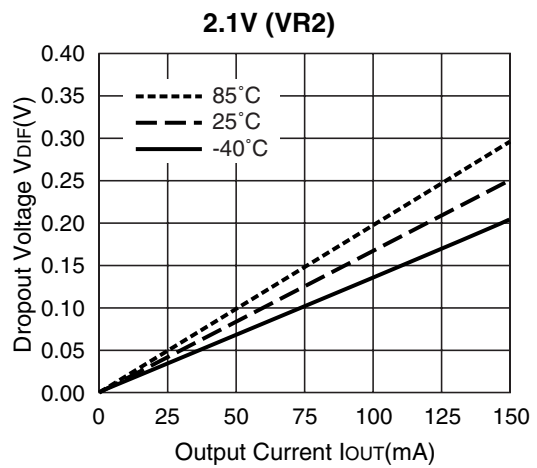
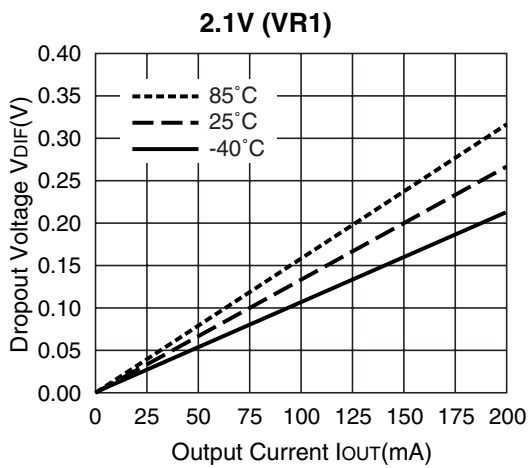
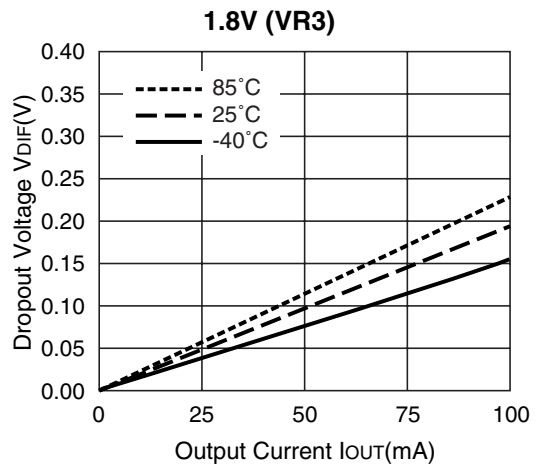
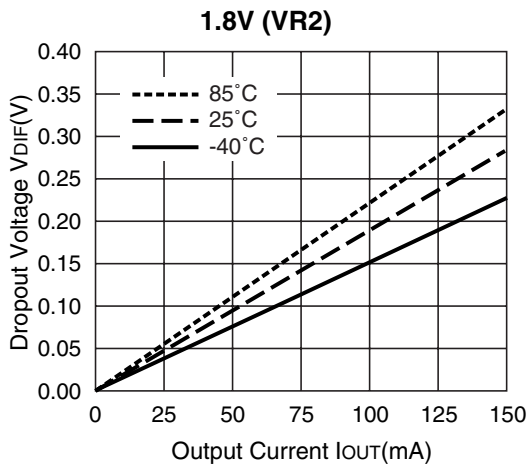
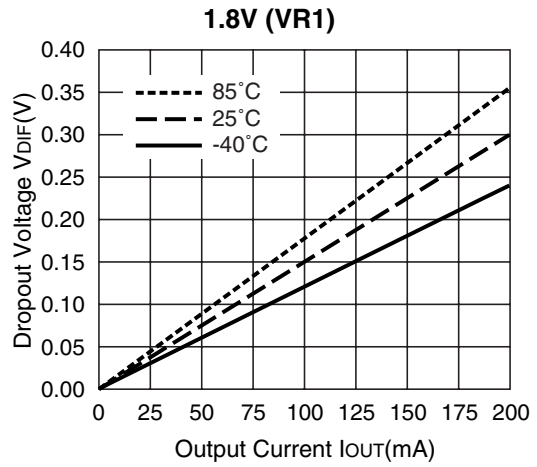
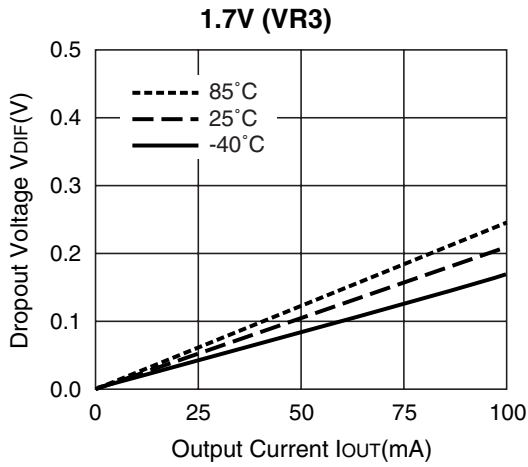



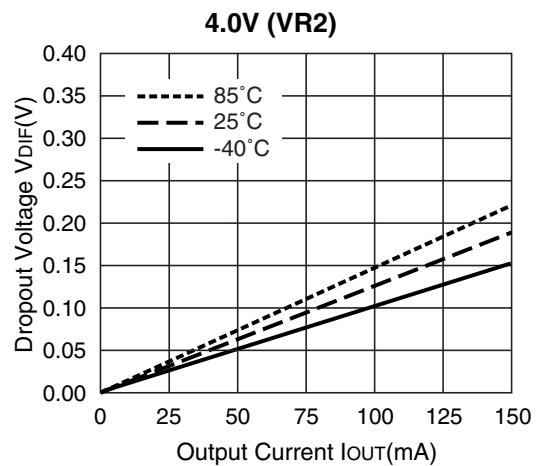
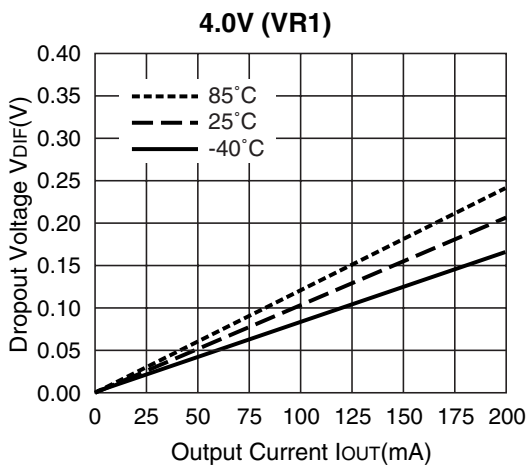
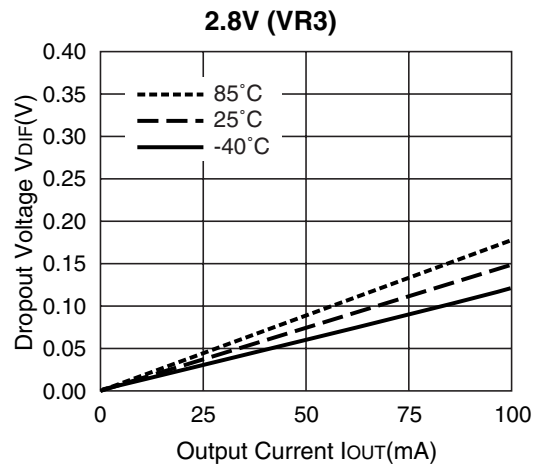
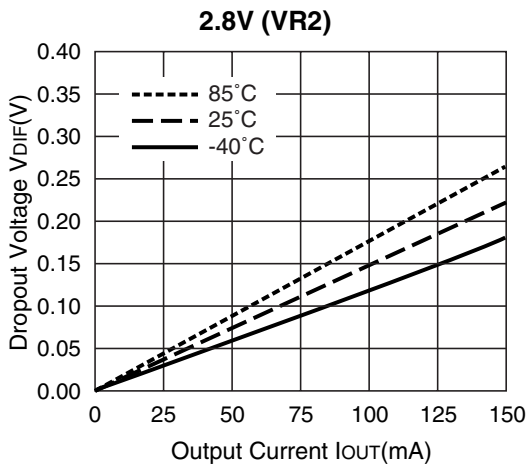
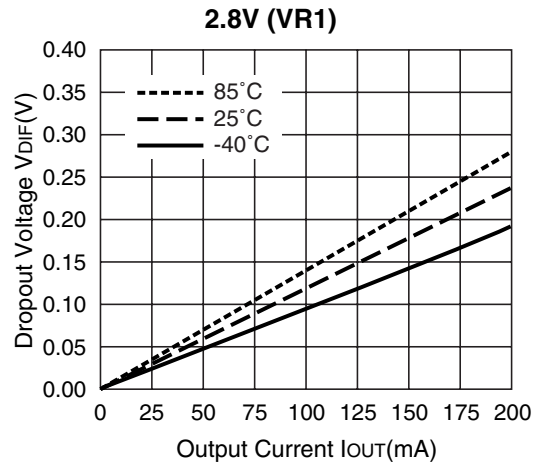
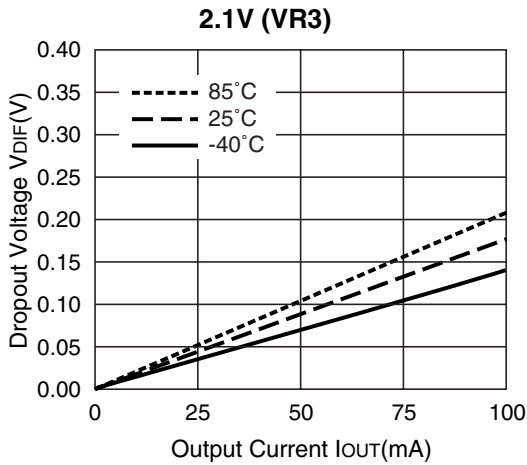

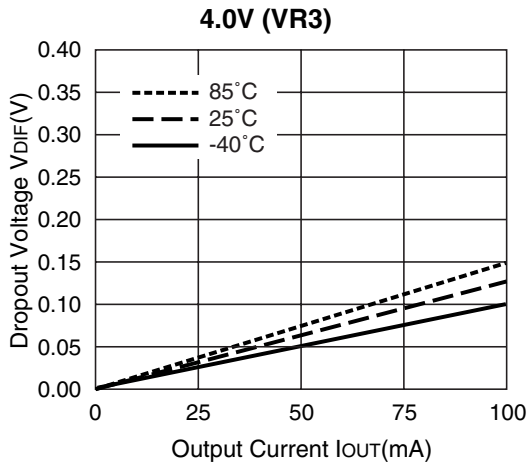

4) Output Voltage vs. Temperature ( $I_{OUT}=30mA$ )

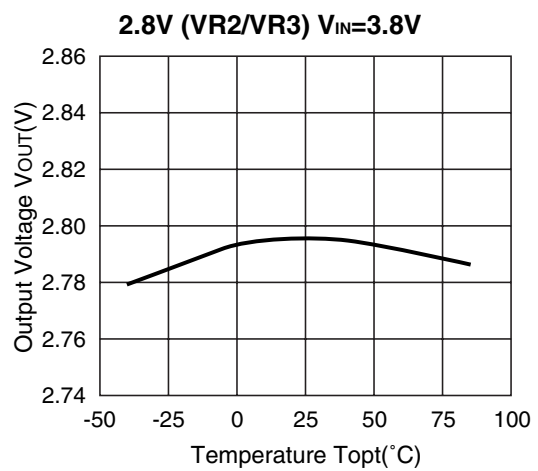
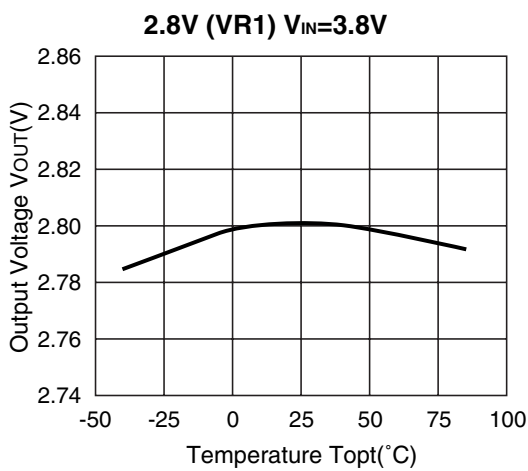
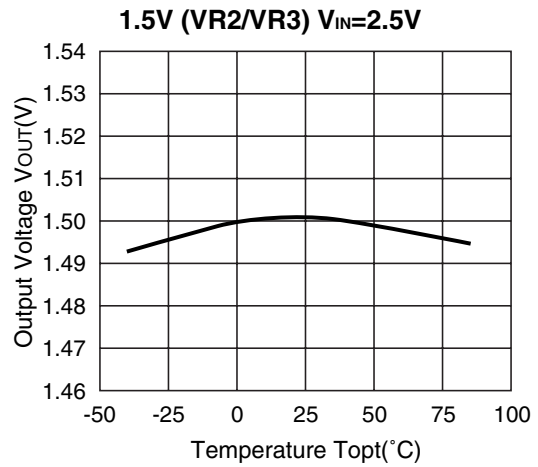
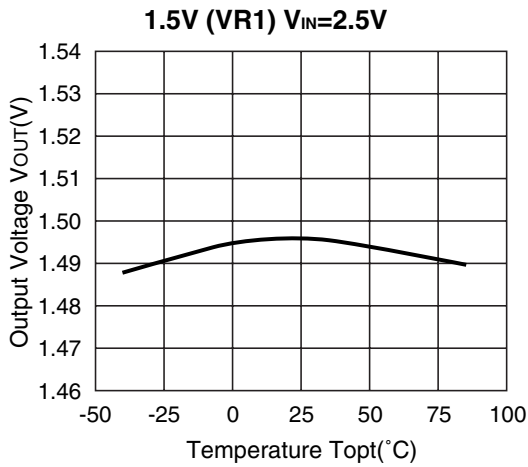

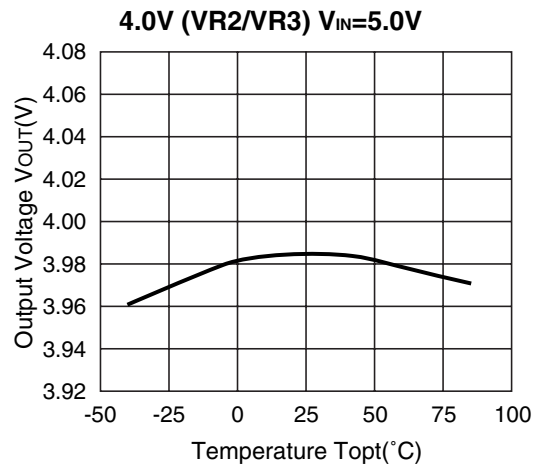
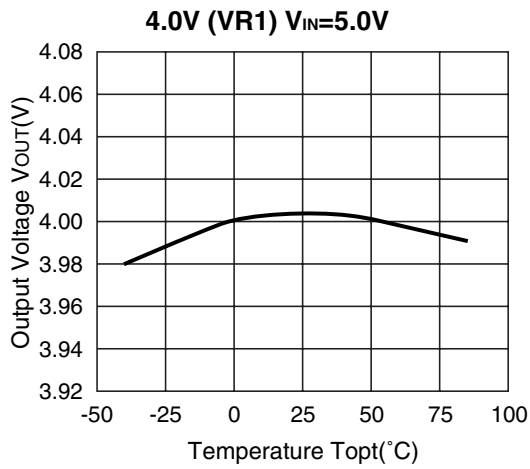

5) Supply Current vs. Input Voltage ( $T_{opt}=25^{\circ}C$ )

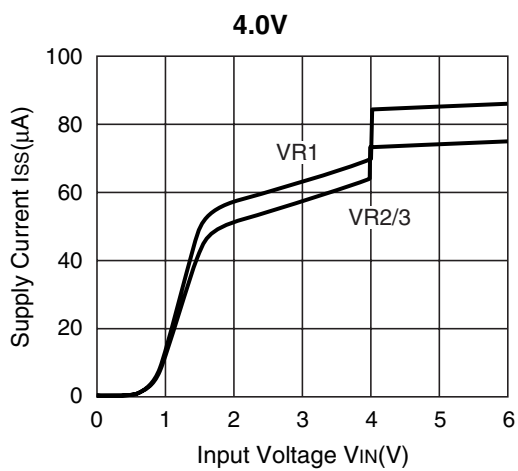
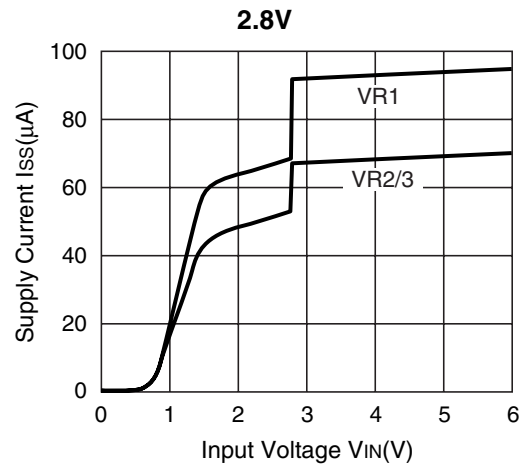
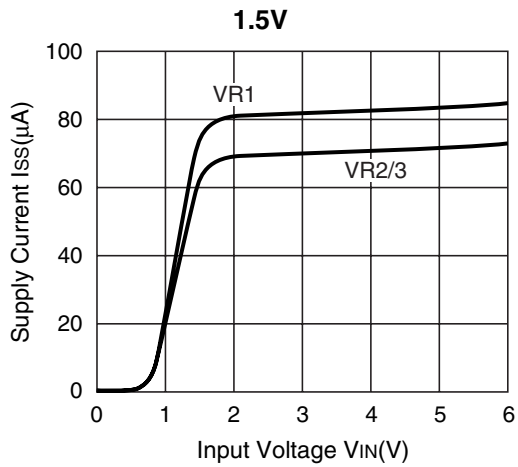

6) Supply Current vs. Temperature

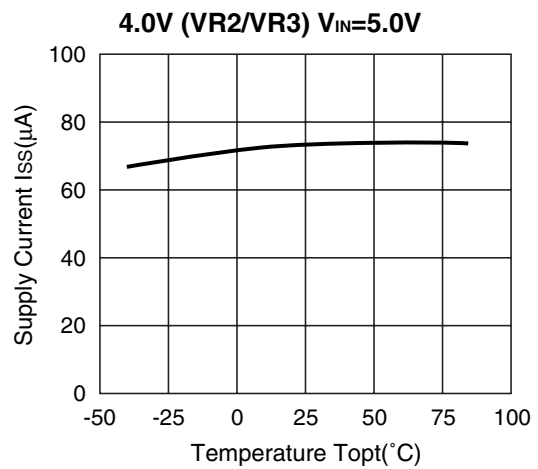
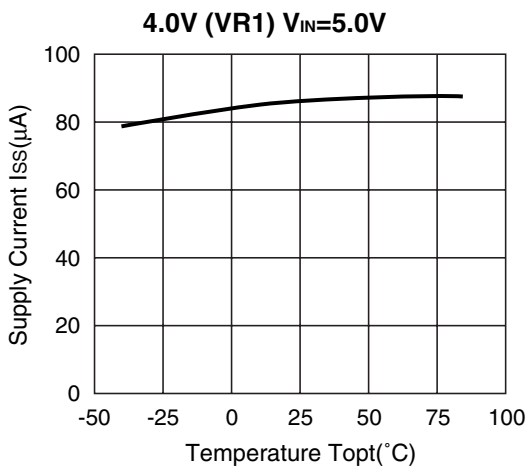
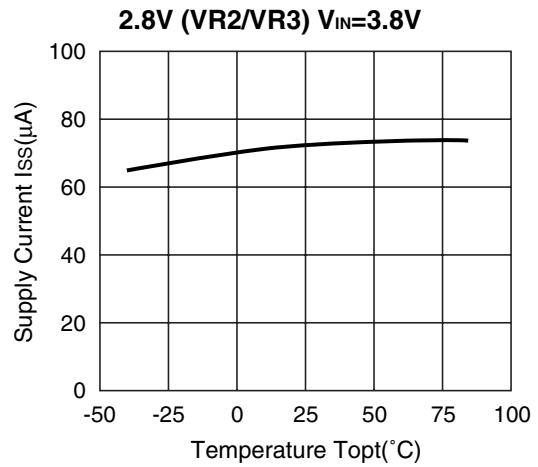
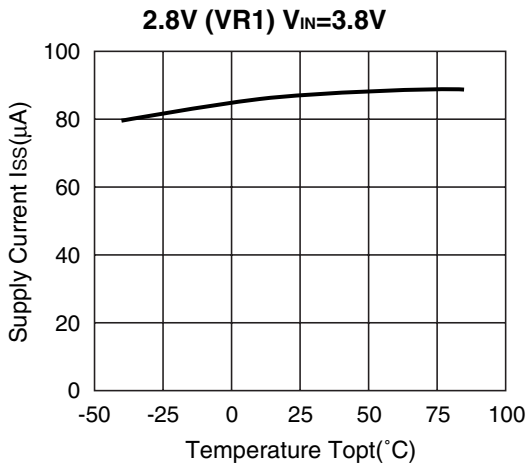
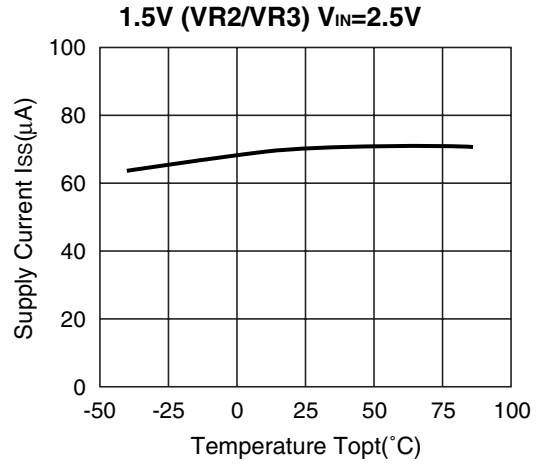
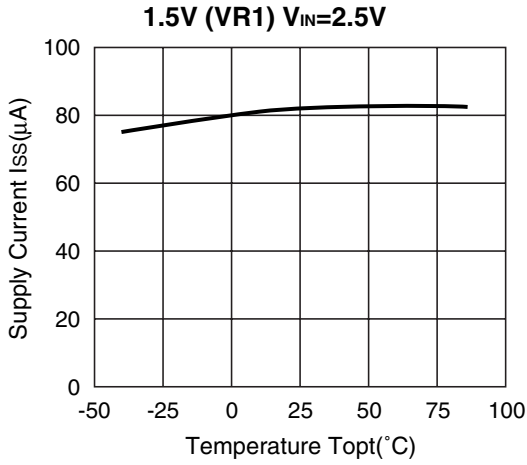

7) Dropout Voltage vs. Set Output Voltage (T<sub>opt</sub>=25°C)

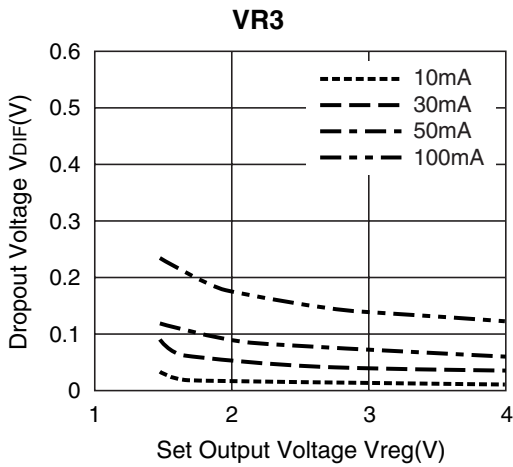
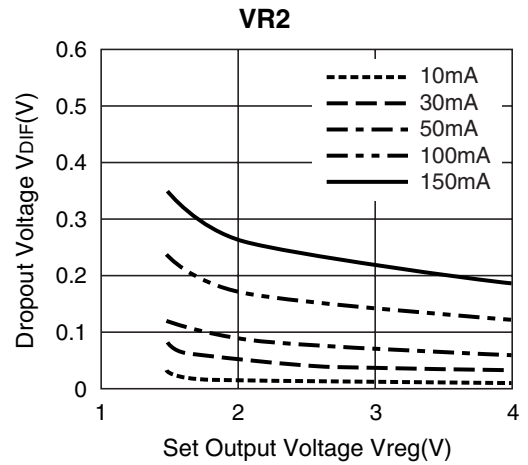
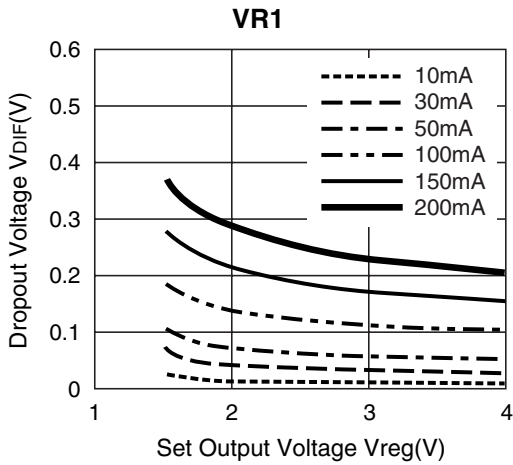

8) Ripple Rejection vs. Frequency (T<sub>opt</sub>=25°C, C<sub>OUT</sub>=Ceramic 1.0μF)

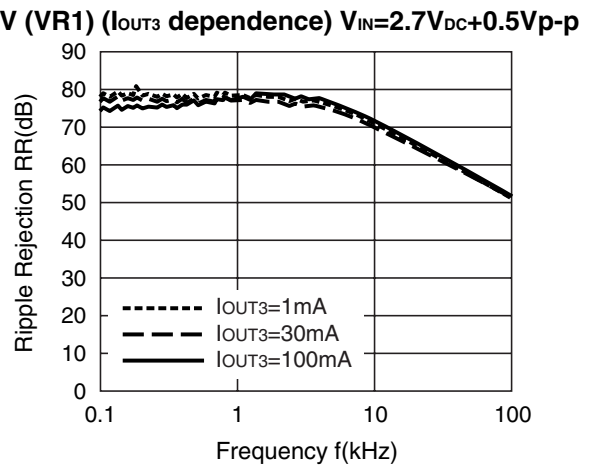
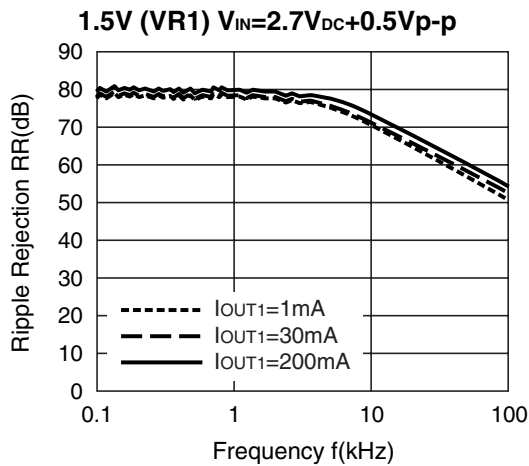

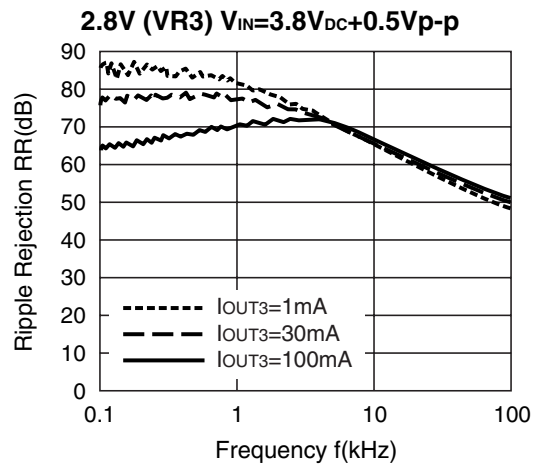
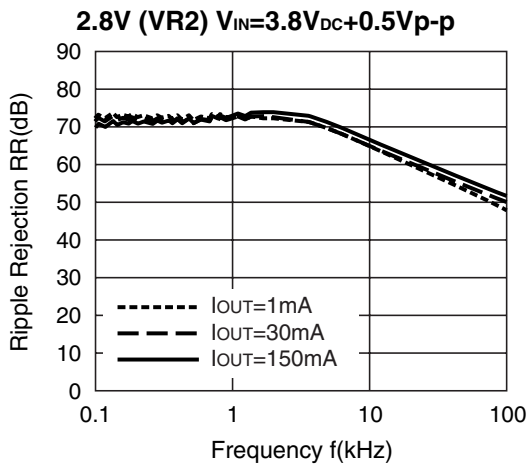
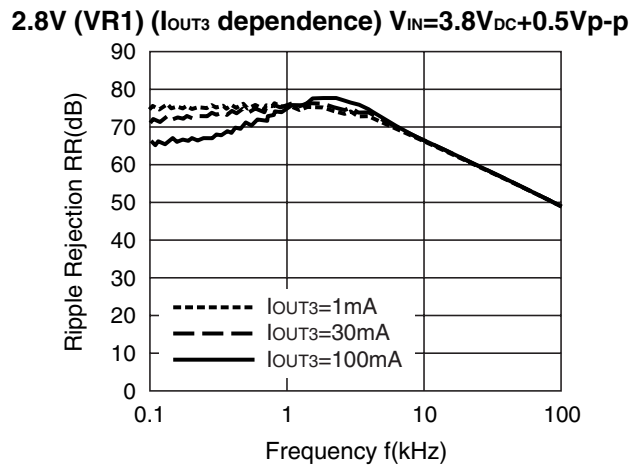
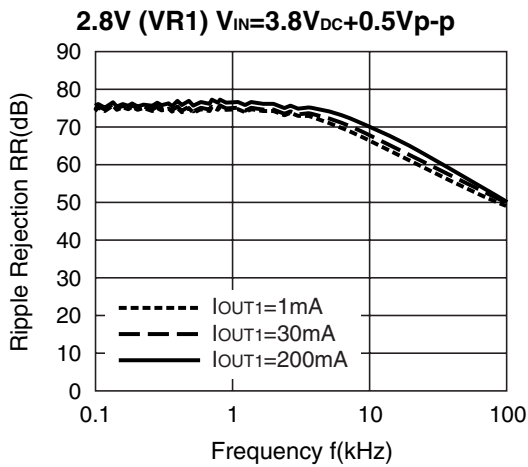
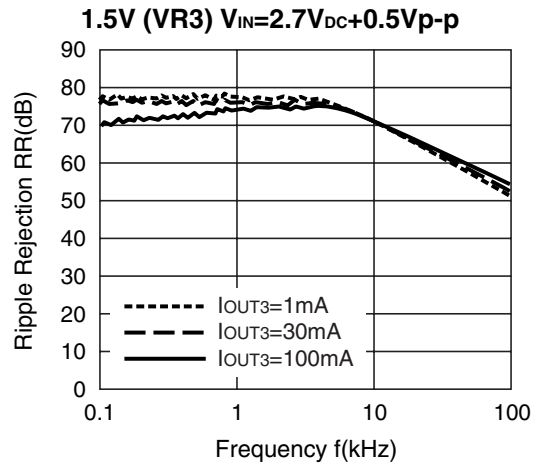
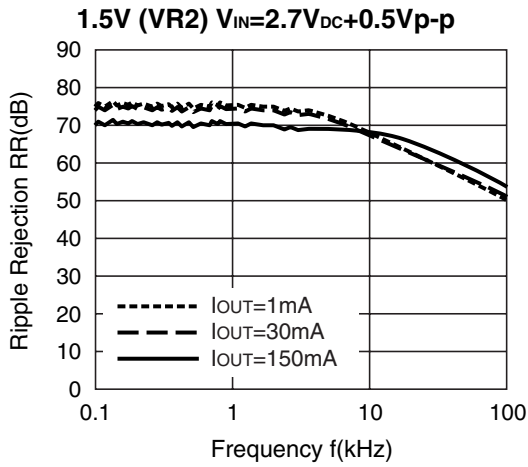

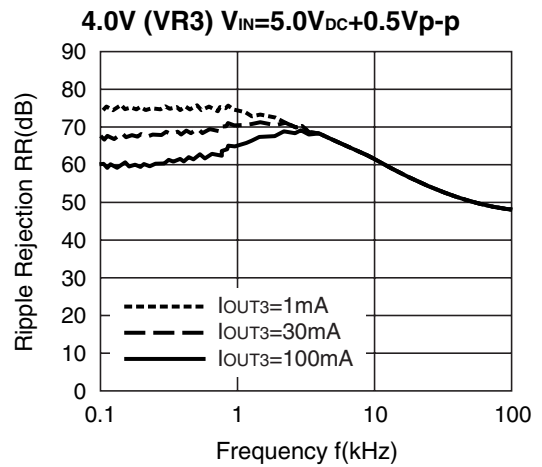
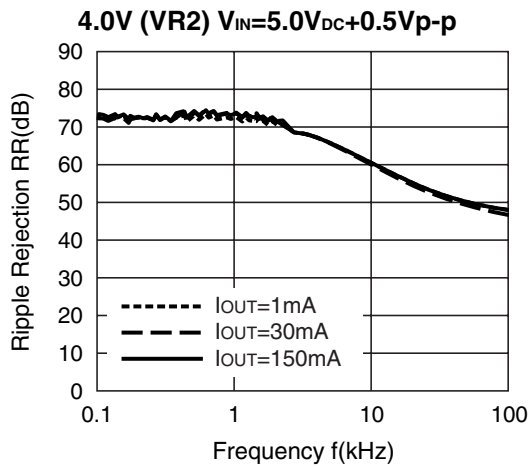
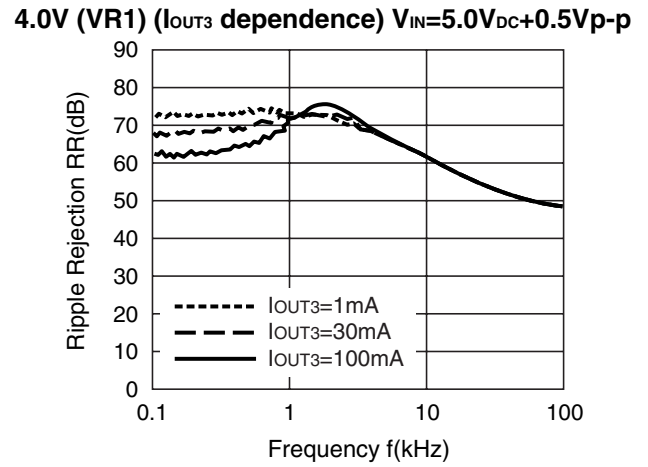
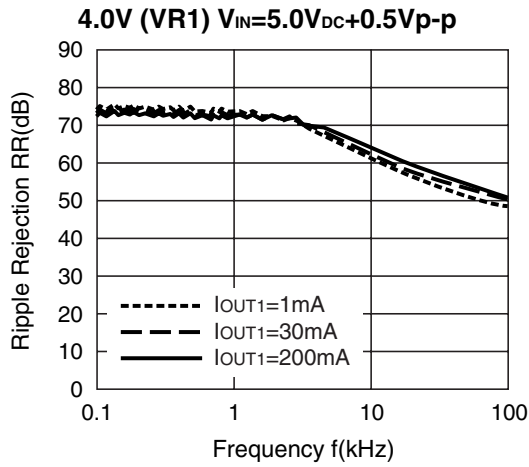

9) Ripple Rejection vs. DC Input Bias ( $T_{opt}=25^{\circ}C$ ,  $C_{OUT}=1.0\mu F$ )

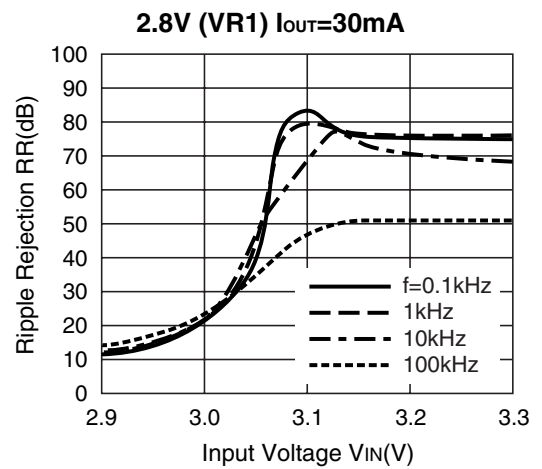
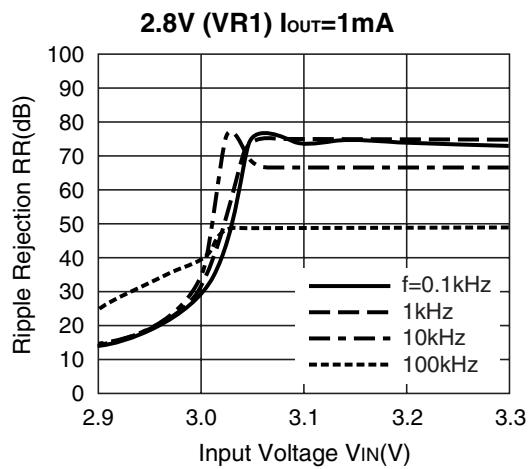

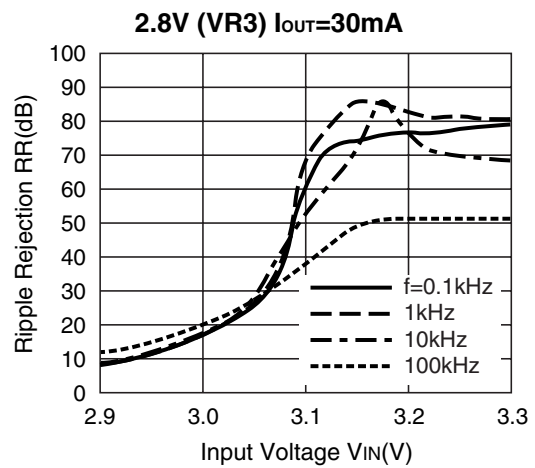
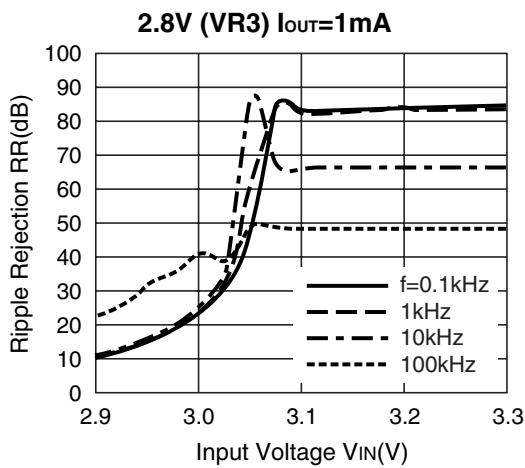
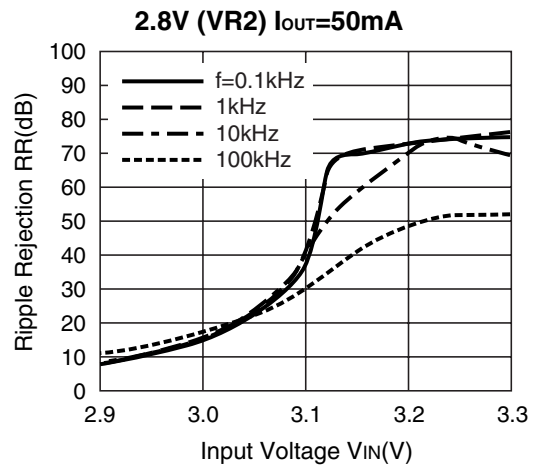
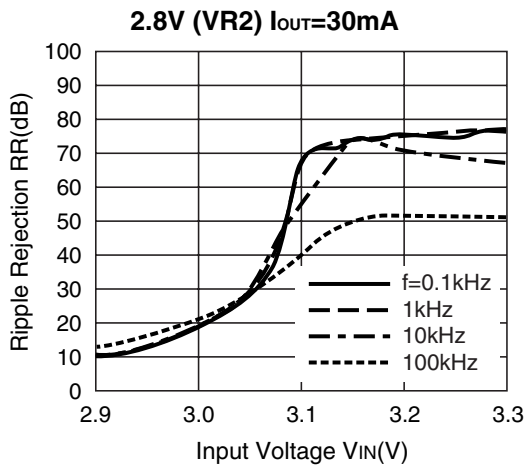
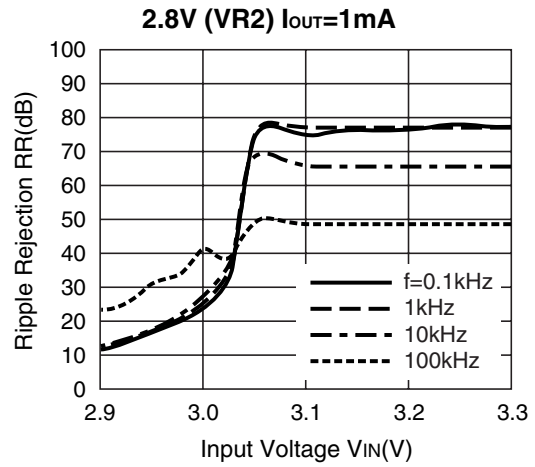
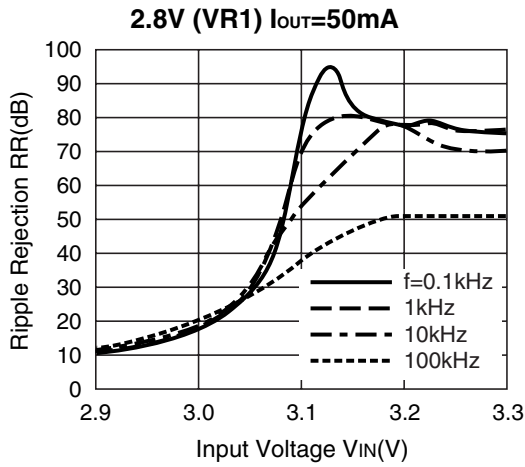



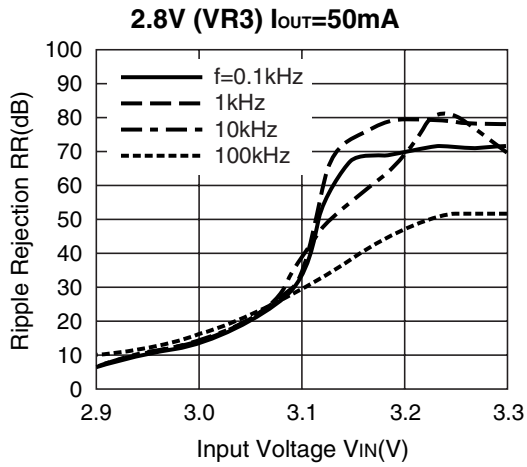

10) Line Transient Response ( $C_{IN}=none$ ,  $I_{OUT}=30mA$ ,  $t_r=t_f=5\mu s$ ,  $C_{OUT}=Ceramic\ 1.0\mu F$ )

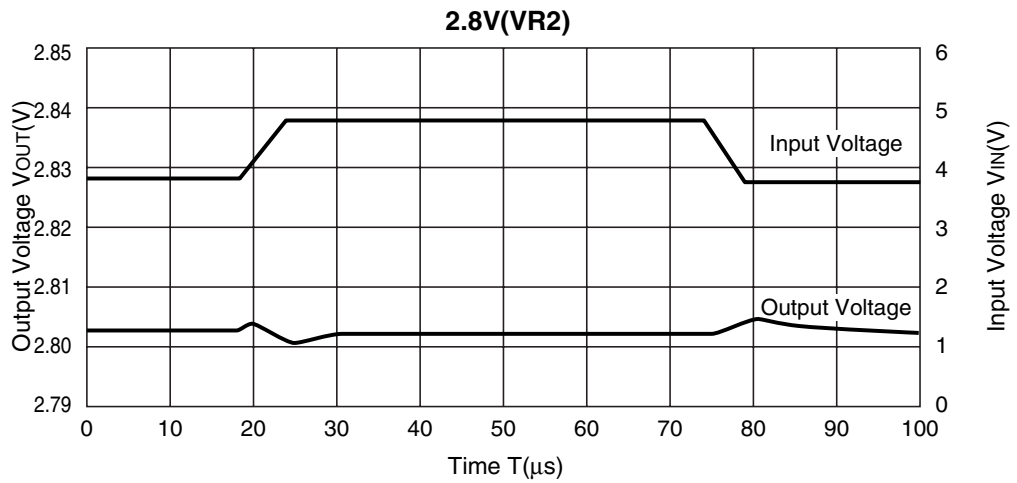
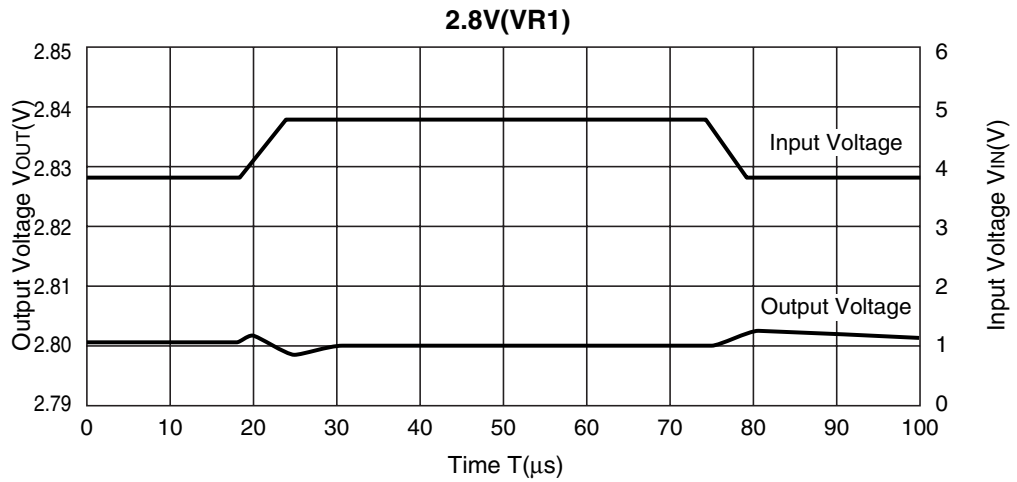

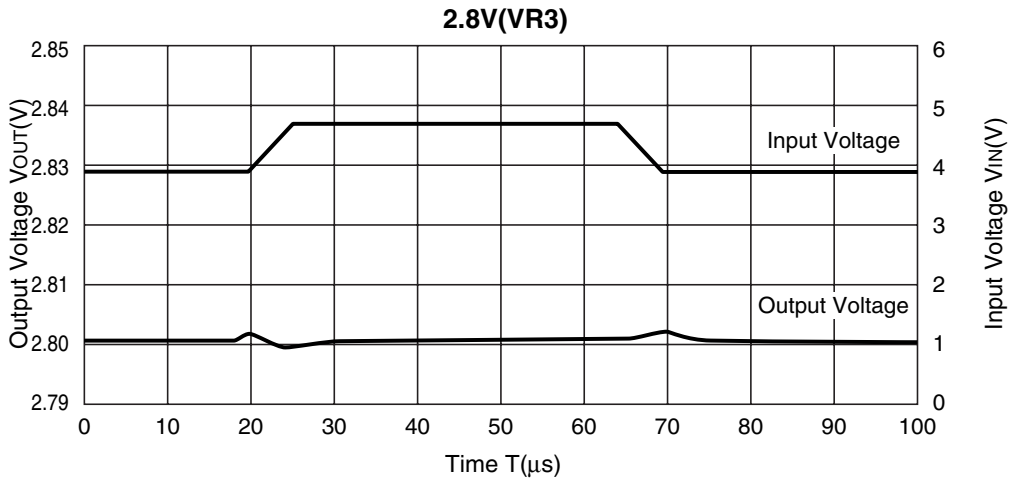

11) Load Transient Response ( $C_{IN}$ =Ceramic 1.0μF,  $C_{OUT}$ =Ceramic 1.0μF)

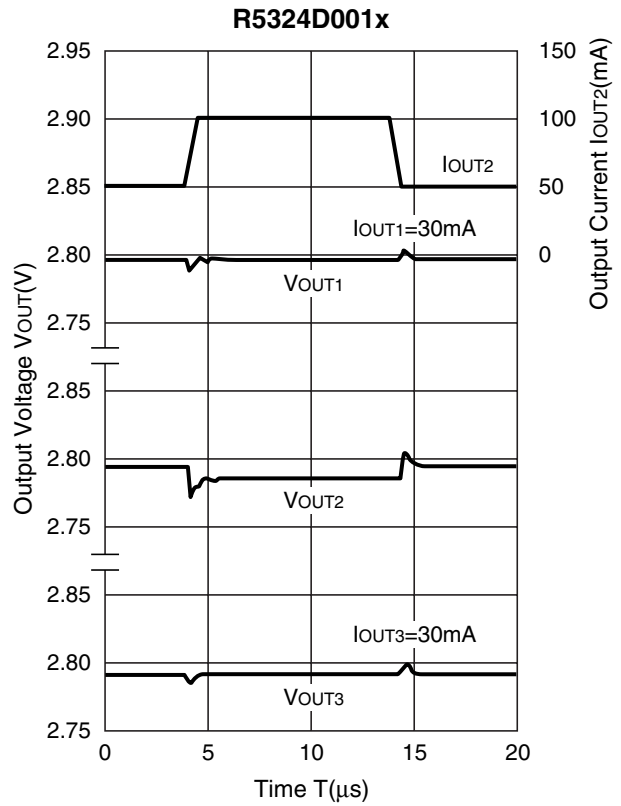
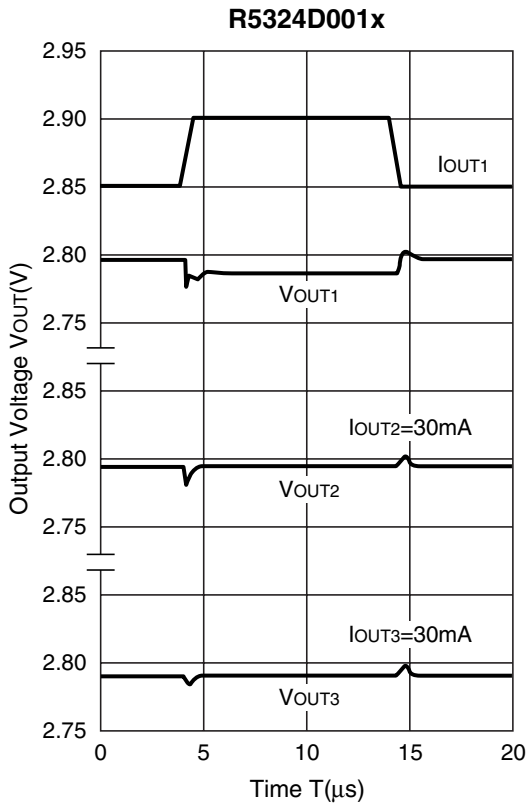

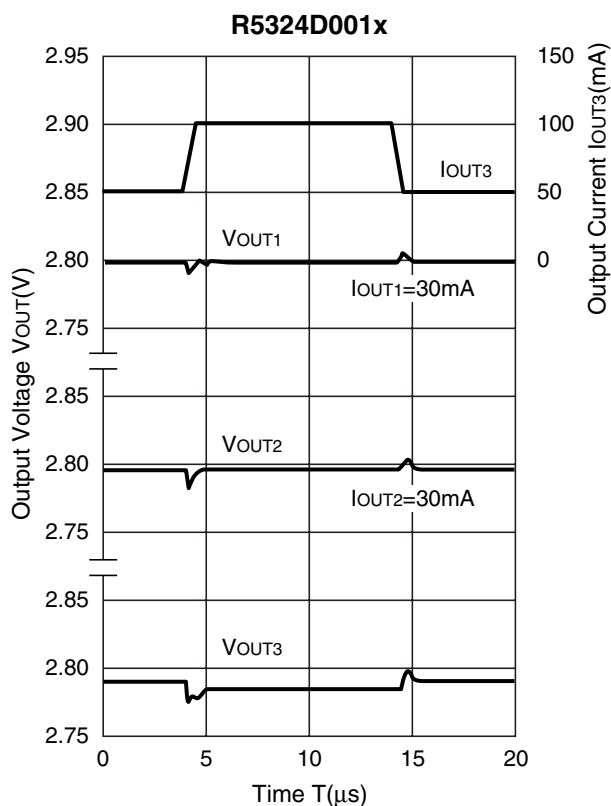

## TECHNICAL NOTES

To use this IC, ESR of the output capacitors should be set in the range of the following graphs.

Noise level is measured with a spectrum analyzer and hatched area shows stable areas of which noise level is approximately equal or less than  $40\mu V$  (Avg.). The relation between Load Current ( $I_{OUT}$ ) and Equivalent Series Resistors (ESR) value of external output capacitor with the stable area is shown below;

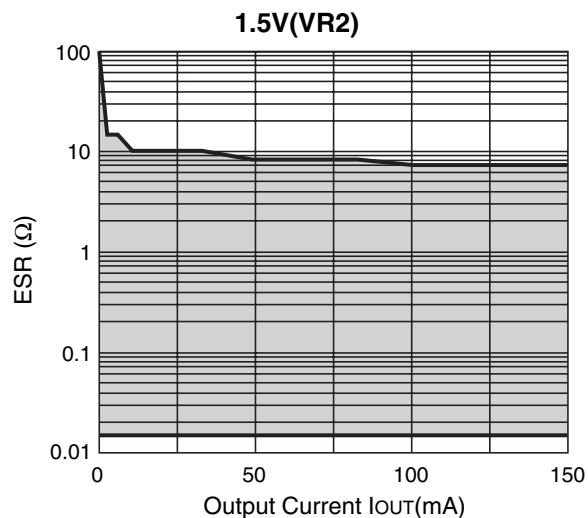
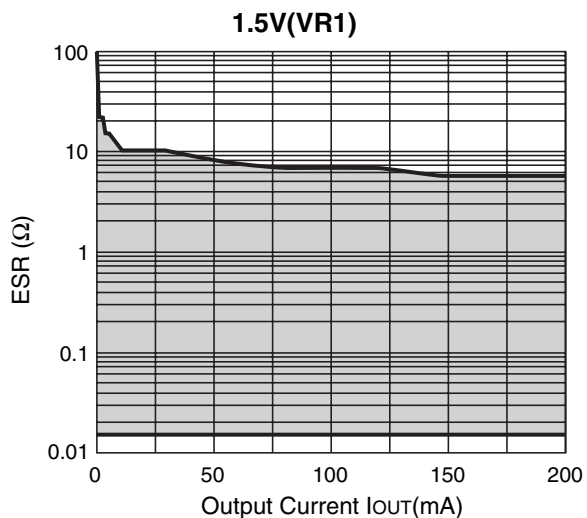

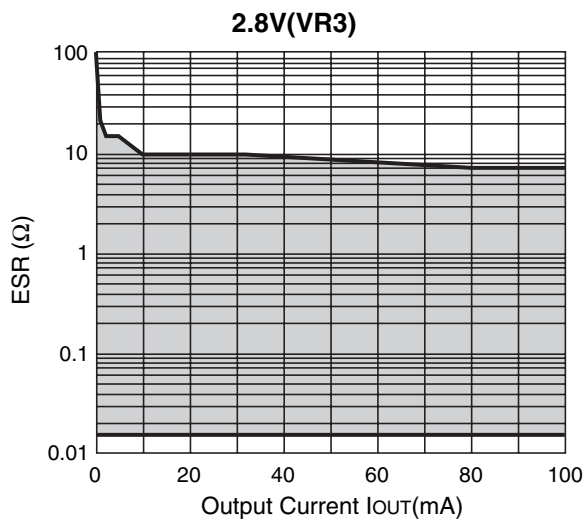
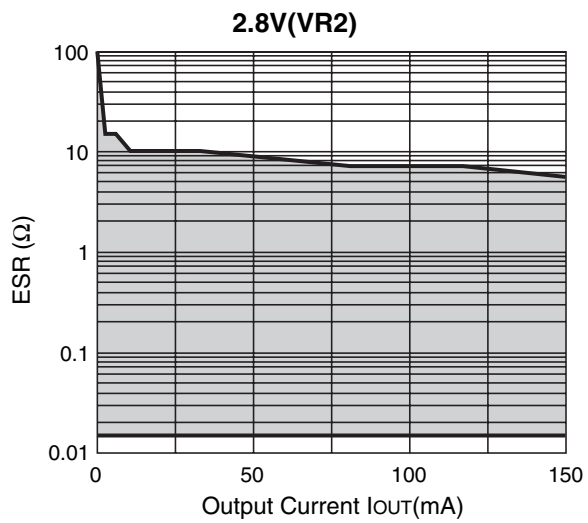
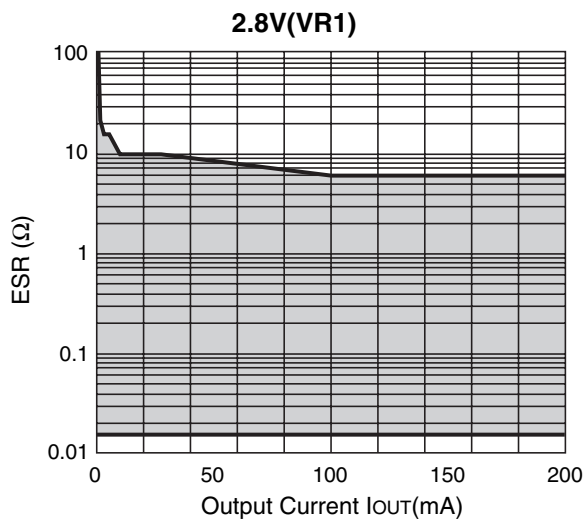
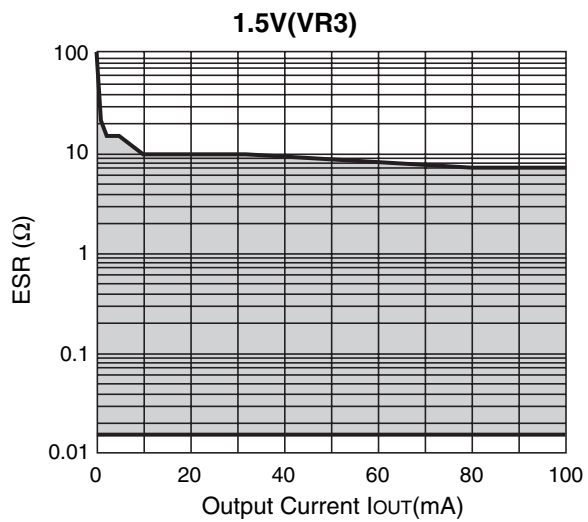

Measuring Conditions

Frequency Band : 10Hz to 2MHz

Temperature : -40°C to 85°C