

### Specifications

Parameter	Unit	Minimum	Typical	Maximum
Center Frequency	MHz	73.9	74	74.1
Insertion Loss	dB	-	25.7	27
1 dB Bandwidth	MHz	7.5	7.67	-
3 dB Bandwidth	MHz	8	8.1	-
40 dB Bandwidth	MHz	-	9.67	9.8
50 dB Bandwidth	MHz	-	9.83	-
Passband Variation( $f_0 \pm 3.5\text{MHz}$ )	dB	-	0.3	0.7
Absolute Delay	usec	-	2.05	-
Phase Linearity( $f_0 \pm 3.5\text{MHz}$ )	deg	-	3	4
Group Delay Variation( $f_0 \pm 3.5\text{MHz}$ )	nsec	-	40	70
Ultimate Rejection	dB	50	60	-
Material Temperature coefficient	KHz/°C	-6.068		
Ambient Temperature	°C	25		
Package Size	DIP2712 (27.2x12.7x5.2mm3)			

#### Notes:

1. All specifications are based on the test circuit shown
2. In production, devices will be tested at room temperature to a guardbanded specification to ensure electrical compliance over temperature
3. Electrical margin has been built into the design to account for the variations due to temperature drift and manufacturing tolerances
4. This is the optimum impedance in order to achieve the performance show

### Matching Configuration

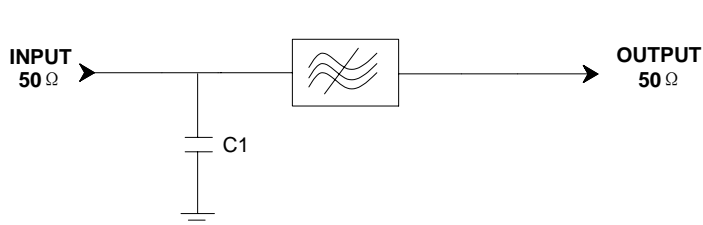

**C1=56pF**  
**Source/Load Impedance=50 ohm**

Notes - Component values may change depending on board layout.

	<b>SIPAT Co., Ltd.</b> ( CETC No. 26 Research Institute ) Nanping Huayuan Road No. 14 Chongqing, China, 400060	Part Number	LBN07403	
		Rev. Date	2006-8-13	
		Rev.	1.0	Page

*Package Dimension*

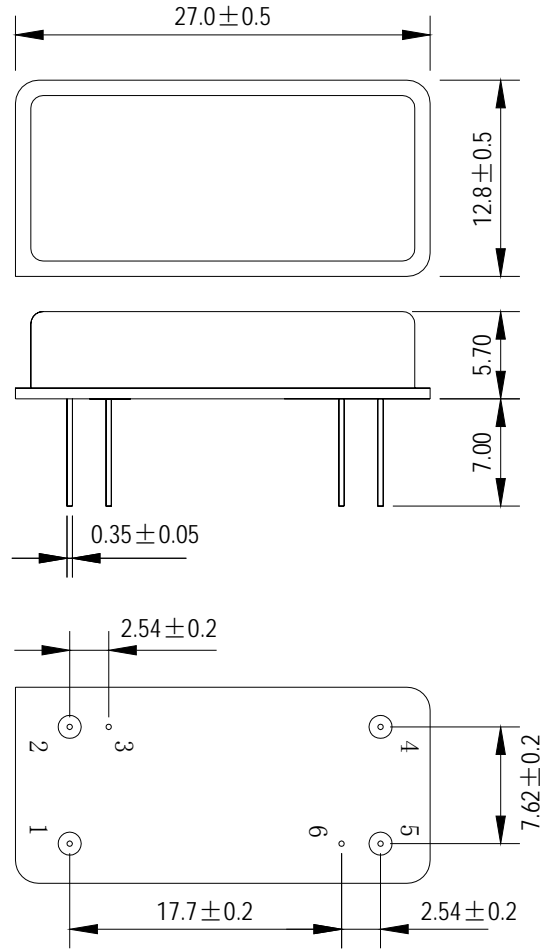

Package: DIP2712

Unit: mm

Input                    1  
Output                    4  
Ground                    2, 3, 5, 6

**Package: DIP2712**

**Unit: mm**



**SIPAT Co., Ltd.**  
( CETC No. 26 Research Institute )  
Nanping Huayuan Road No. 14  
Chongqing, China, 400060

Part Number	LBN07403	
Rev. Date	2006-8-13	
Rev.	1.0	Page 2/3

Typical Performance

Frequency Respond

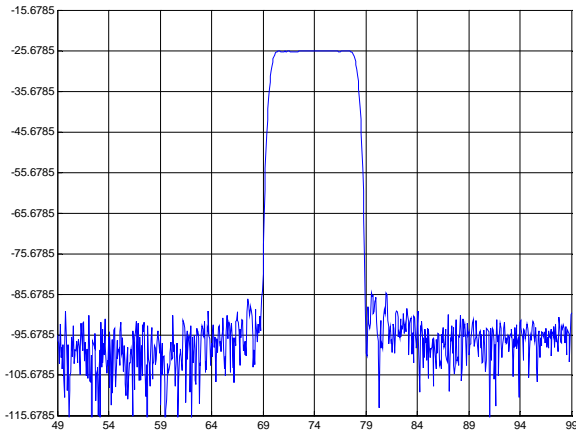

Passband Respond

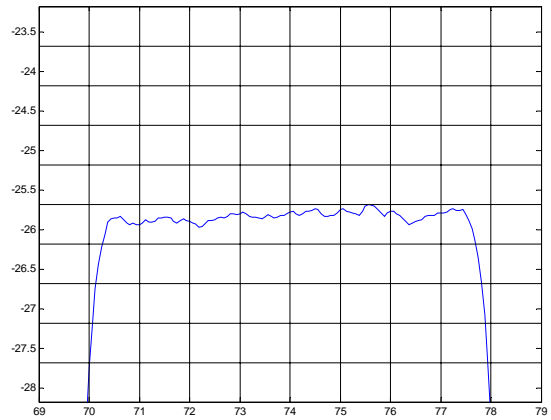

Group Delay Variation( $f_0 \pm 3.5\text{MHz}$ )

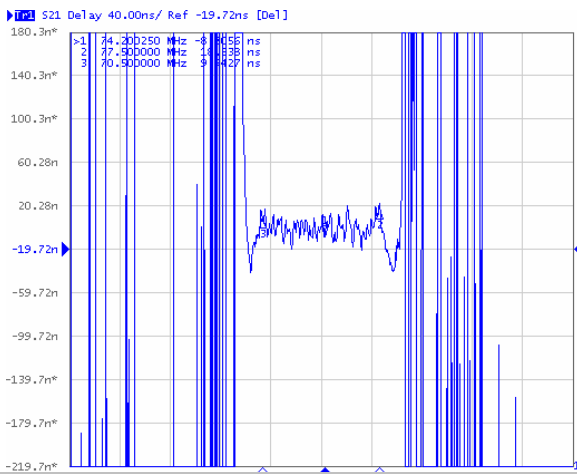

Phase Linearity( $f_0 \pm 3.5\text{MHz}$ )

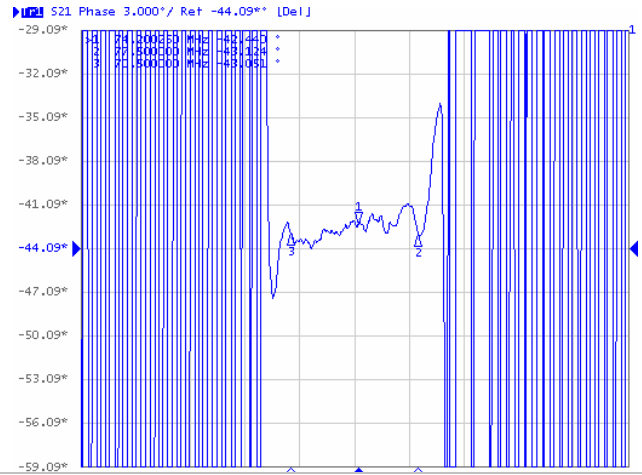

Smith Chart S11

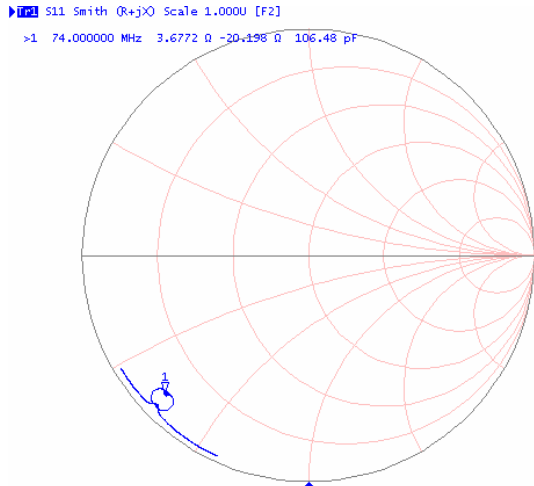

Smith Chart S22

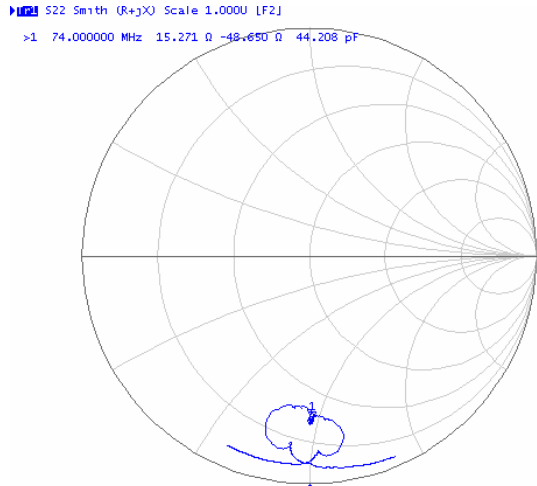

**SIPAT Co., Ltd.**  
( CETC No. 26 Research Institute )  
Nanping Huayuan Road No. 14  
Chongqing, China, 400060

Part Number

LBN07403

Rev. Date

2006-8-13

Rev.

1.0

Page 3/3