

### Specifications

| Parameter                                    | Unit                                    | Minimum          | Typical | Maximum |
|--|---|------------------|---------|---------|
| Center Frequency                             | MHz                                     | 69.95            | 70      | 70.05   |
| Insertion Loss                               | dB                                      |                  | 28      | 28.5    |
| 3 dB Bandwidth                               | MHz                                     | 13.3             | 13.35   | 13.4    |
| 35 dB Bandwidth                              | MHz                                     |                  | 14.06   | 14.15   |
| 45 dB Bandwidth                              | MHz                                     |                  | 14.15   | 14.5    |
| 50 dB Bandwidth                              | MHz                                     |                  | 14.17   | 15.3    |
| 55 dB Bandwidth                              | MHz                                     |                  | 14.19   | 15.4    |
| Passband Variation                           | dB                                      |                  | 0.5     | 1       |
| Absolute Delay                               | usec                                    |                  | 3.67    | 4       |
| Ultimate Rejection( $f_0 \pm 15\text{MHz}$ ) | dB                                      | 55               | 60      |         |
| Material temperature coefficient             | KHz/°C                                  | -94x $F_0$ /1000 |         |         |
| Ambient Temperature                          | °C                                      | 25               |         |         |
| Package Size                                 | DIP3512 (35.2x12.7x5.2mm <sup>3</sup> ) |                  |         |         |

#### Notes:

1. All specifications are based on the test circuit shown
2. In production, devices will be tested at room temperature to a guardbanded specification to ensure electrical compliance over temperature
3. Electrical margin has been built into the design to account for the variations due to temperature drift and manufacturing tolerances
4. This is the optimum impedance in order to achieve the performance show

### Matching Configuration

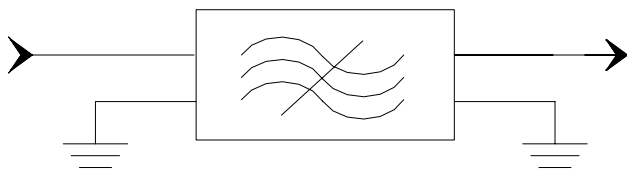

**Source/Load Impedance=50 ohm**

Notes - Component values may change depending  
on board layout.



**SIPAT Co., Ltd.**  
( CETC No. 26 Research Institute )  
Nanping Huayuan Road No. 14  
Chongqing, China, 400060

|             |           |          |  |
|-------------|-----------|----------|--|
| Part Number | LBN07097  |          |  |
| Rev. Date   | 2005-6-30 |          |  |
| Rev.        | 1.0       | Page 1/3 |  |

*Package Dimension*

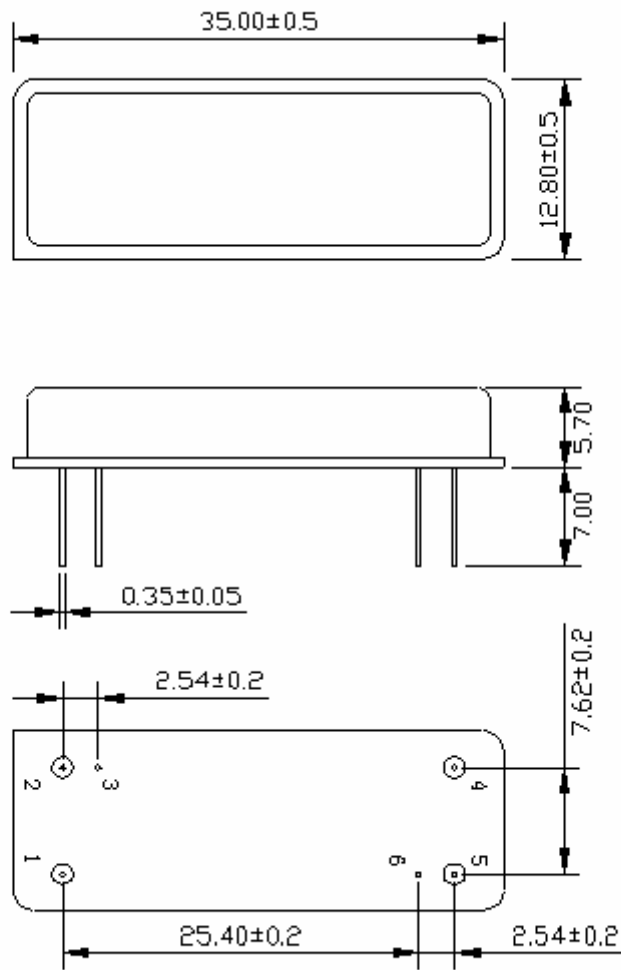

**SIPAT Co., Ltd.**  
( CETC No. 26 Research Institute )  
Nanping Huayuan Road No. 14  
Chongqing, China, 400060

|             |           |          |
|-------------|-----------|----------|
| Part Number | LBN07097  |          |
| Rev. Date   | 2005-6-30 |          |
| Rev.        | 1.0       | Page 2/3 |

Typical Performance

Frequency Respond

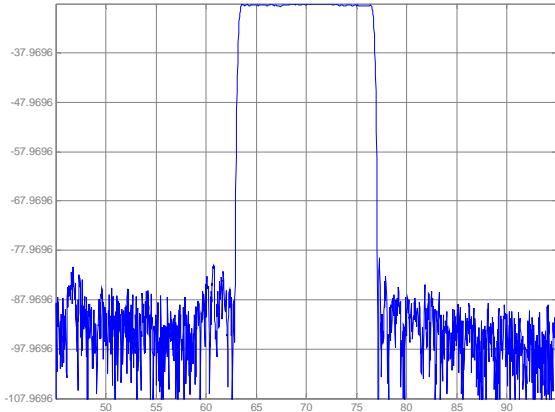

Passband Respond

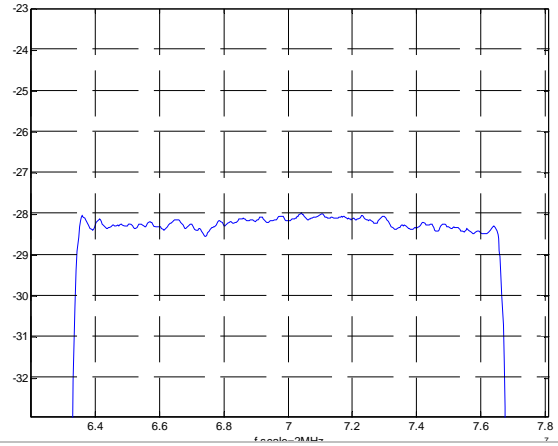

Group Delay Variation( $f_0 \pm 5.5\text{MHz}$ )

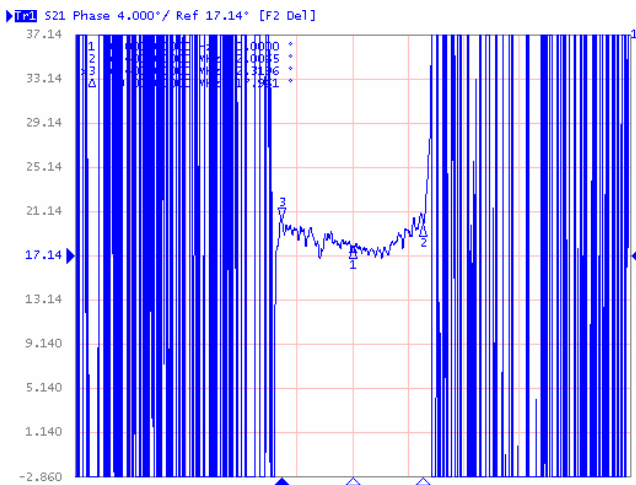

Phase Linearity( $f_0 \pm 5.5\text{MHz}$ )

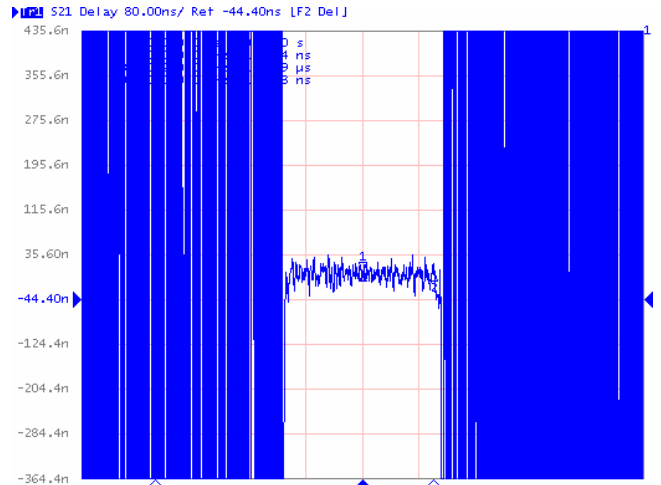

Smith Chart S11

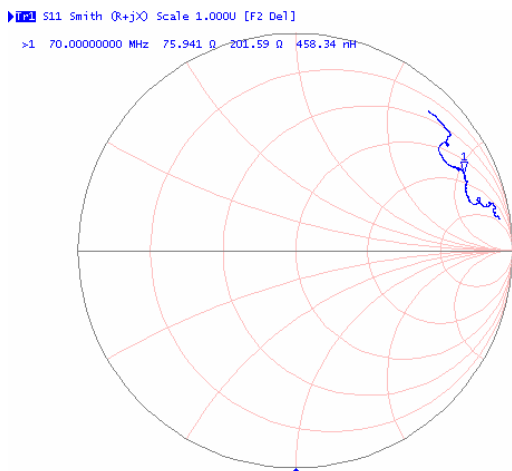

Smith Chart S22

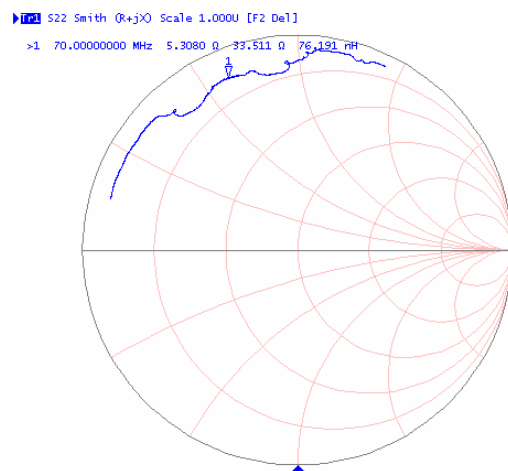

**SIPAT Co., Ltd.**  
( CETC No. 26 Research Institute )  
Nanping Huayuan Road No. 14  
Chongqing, China, 400060

|             |           |          |
|-------------|-----------|----------|
| Part Number | LBN07097  |          |
| Rev. Date   | 2005-6-30 |          |
| Rev.        | 1.0       | Page 3/3 |