

T-1^{3/4} (5 mm), T-1 (3 mm), Low Current LED Lamps

Technical Data

HLMP-4700, -4719, -4740
HLMP-1700, -1719, -1790

Features

- Low Power
- High Efficiency
- CMOS-MOS Compatible
- TTL Compatible
- Wide Viewing Angle
- Choice of Package Styles
- Choice of Colors

Applications

- Low Power DC Circuits
- Telecommunications Indicators

- Portable Equipment
- Keyboard Indicators

Description

These tinted diffused LED lamps are designed and optimized specifically for low DC current operation. Luminous intensity and forward voltage are tested at 2 mA to assure consistent brightness at TTL output current levels.

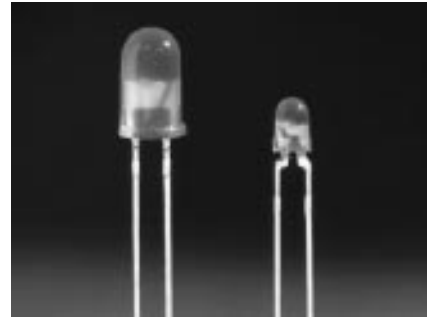

Package Dimensions

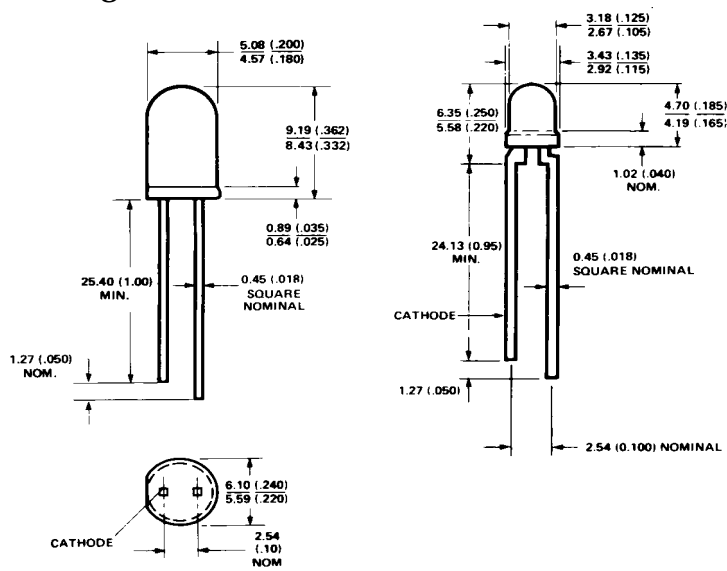

HLMP-4700, -4719, -4740

A

HLMP-1700, -1719, -1790

B

NOTES:
 1. ALL DIMENSIONS ARE IN MILLIMETRES (INCHES).
 2. AN EPOXY MINISCUS MAY EXTEND ABOUT 1 mm (0.040") DOWN THE LEADS.

Selection Guide

Package Description	Color	Device HLMP-	Luminous Intensity Iv (mcd) at 2 mA			$2\theta^{1/2}$	Package Outline
			Min.	Typ.	Max.		
T-1 3/4 Tinted Diffused	Red	4700	1.5	2.3	-	50	A
		4700-C00xx	1.5	2.3	-		
		4700-CD0FH	1.5	2.3	4.2		
	Yellow	4719	0.9	2.1	-		
		4719-A00xx	0.9	2.1	-		
	Green	4740	1.0	2.3	-		
		4740-A00xx	1.0	2.3	-		
		4740-AB000	1.0	2.3	3.2		
	T-1 Tinted Diffused	Red	1700	0.8	2.1		
1700-B00xx			0.8	2.1	-		
Yellow		1719	0.9	2.1	-		
		1719-A00xx	0.9	2.1	-		
		1719-ABB00	0.9	2.1	2.8		
Green		1790	1.0	2.3	-		
		1790-A00xx	1.0	2.3	-		
		1790-AB0FH	1.0	2.4	3.2		

Note:

1. $\theta^{1/2}$ is the typical off-axis angle at which the luminous intensity is half the axial luminous intensity.

Part Numbering System

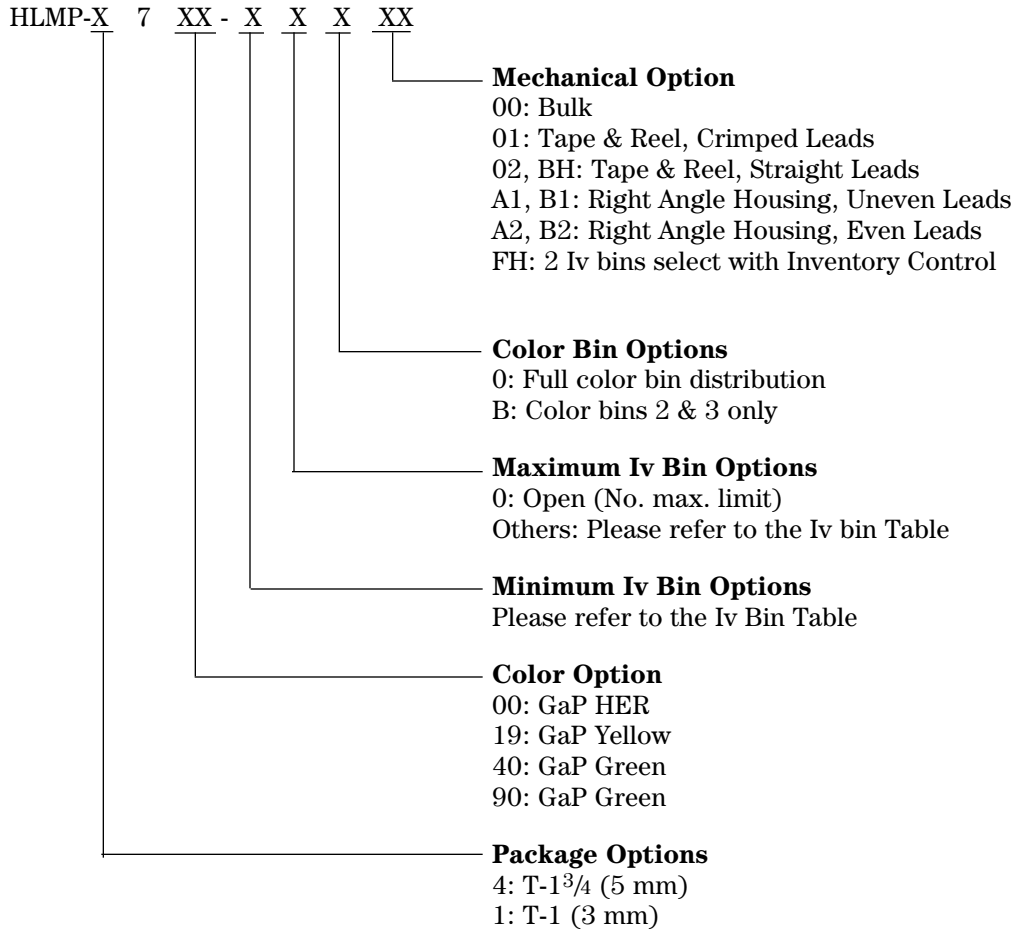

Electrical/Optical Characteristics at $T_A = 25^\circ\text{C}$

Symbol	Description	T-1 ^{3/4}	T-1	Min.	Typ.	Max.	Units	Test Conditions
V_F	Forward Voltage	4700 4719 4740	1700 1719 1790		1.7 1.8 1.9	2.0 2.5 2.2	V	2 mA
V_R	Reverse Breakdown Voltage	4700 4719 4740	1700 1719 1790	5.0 5.0 5.0			V	$I_R = 50 \mu\text{A}$
λ_d	Dominant Wavelength	4700 4719 4740	1700 1719 1790		626 585 569		nm	Note 1
$\Delta\lambda_{1/2}$	Spectral Line Halfwidth	4700 4719 4740	1700 1719 1790		40 36 28		nm	
τ_S	Speed of Response	4700 4719 4740	1700 1719 1790		90 90 500		ns	
C	Capacitance	4700 4719 4740	1700 1719 1790		11 15 18		pF	$V_F = 0$, $f = 1 \text{ MHz}$
$R\theta_{J-PIN}$	Thermal Resistance	4700 4719 4740	1700 1719 1790		260 ^[3] 290 ^[4]		$^\circ\text{C/W}$	Junction to Cathode Lead
λ_{PEAK}	Peak Wavelength	4700 4719 4740	1700 1719 1790		635 583 565		nm	Measurement at peak
η_V	Luminous Efficacy	4700 4719 4740	1700 1719 1790		145 500 595		<u>lumens</u> watt	Note 2

Notes:

1. The dominant wavelength, λ_d , is derived from the CIE chromaticity diagram and represents the single wavelength which defines the color of the device.
2. The radiant intensity, I_e , in watts per steradian, may be found from the equation $I_e = I_v/\eta_V$, where I_v is the luminous intensity in candelas and η_V is luminous efficacy in lumens/watt.
3. T-1^{3/4}.
4. T-1.

Absolute Maximum Ratings

Parameter	Maximum Rating		Units
Power Dissipation (Derate linearly from 92°C at 1.0 mA/°C)	Red Yellow Green	24 36 24	mW
DC and Peak Forward Current	7		mA
Transient Forward Current (10 μ s Pulse) ^[1]	500		mA
Reverse Voltage ($I_R = 50 \mu$ A)	5.0		V
Operating Temperature Range	Red/Yellow Green	-55°C to 100°C -20°C to 100°C	
Storage Temperature Range	-55°C to +100°C		
Lead Soldering Temperature [1.6 mm (0.063 in.) from body]	260°C for 5 seconds		

Note:

1. The transient peak current is the maximum non-recurring peak current the devices can withstand without damaging the LED die and wire bonds. It is not recommended that the device be operated at peak currents beyond the Absolute Maximum Peak Forward Current.

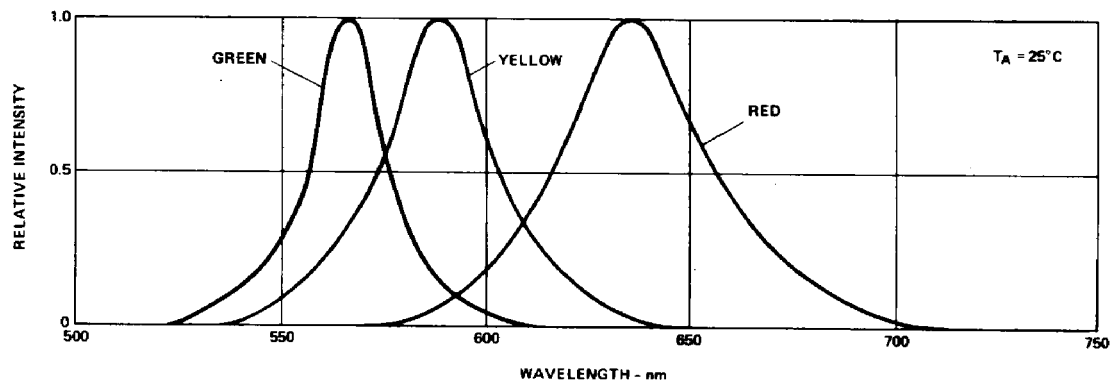

Figure 1. Relative Intensity vs. Wavelength.

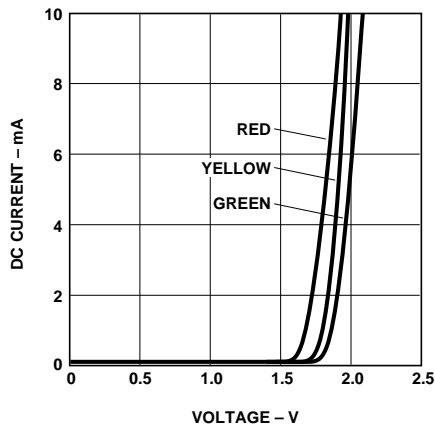

Figure 2. Forward Current vs. Forward Voltage.

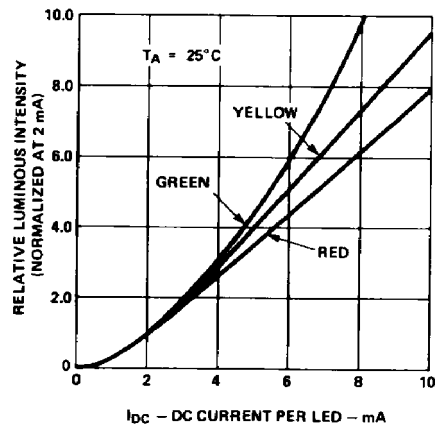

Figure 3. Relative Luminous Intensity vs. Forward Current.

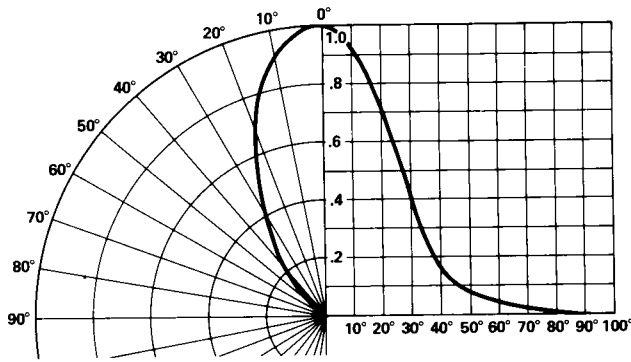

Figure 4. Relative Luminous Intensity vs. Angular Displacement for T-1^{3/4} Lamp.

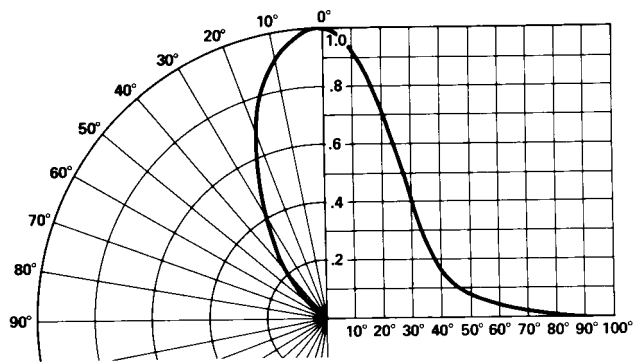

Figure 5. Relative Luminous Intensity vs. Angular Displacement for T-1 Lamp.

Intensity Bin Limits

Color	Bin	Intensity Range (mcd)	
		Min.	Max.
Red	B	0.9	1.5
	C	1.5	2.4
	D	2.4	3.8
	E	3.8	6.1
	F	6.1	9.7
	G	9.7	15.5
	H	15.5	24.8
	I	24.8	39.6
	J	39.6	63.4
	K	63.4	101.5
	L	101.5	162.4
	M	162.4	234.6
	N	234.6	340.0
	O	340.0	540.0
	P	540.0	850.0
	Q	850.0	1200.0
	R	1200.0	1700.0
	S	1700.0	2400.0
	T	2400.0	3400.0
	U	3400.0	4900.0
V	4900.0	7100.0	
W	7100.0	10200.0	
X	10200.0	14800.0	
Y	14800.0	21400.0	
Z	21400.0	30900.0	

Maximum tolerance for each bin limit is $\pm 18\%$.

Intensity Bin Limits, continued

Color	Bin	Intensity Range (mcd)	
		Min.	Max.
Yellow	A	1.0	1.6
	B	1.6	2.5
	C	2.5	4.0
	D	4.0	6.5
	E	6.5	10.3
	F	10.3	16.6
	G	16.6	26.5
	H	26.5	42.3
	I	42.3	67.7
	J	67.7	108.2
	K	108.2	173.2
	L	173.2	250.0
	M	250.0	360.0
	N	360.0	510.0
	O	510.0	800.0
	P	800.0	1250.0
	Q	1250.0	1800.0
	R	1800.0	2900.0
	S	2900.0	4700.0
T	4700.0	7200.0	
U	7200.0	11700.0	
V	11700.0	18000.0	
W	18000.0	27000.0	

Maximum tolerance for each bin limit is $\pm 18\%$.

Intensity Bin Limits, continued

Color	Bin	Intensity Range (mcd)	
		Min.	Max.
Green	A	1.1	1.8
	B	1.8	2.9
	C	2.9	4.7
	D	4.7	7.6
	E	7.6	12.0
	F	12.0	19.1
	G	19.1	30.7
	H	30.7	49.1
	I	49.1	78.5
	J	78.5	125.7
	K	125.7	201.1
	L	201.1	289.0
	M	289.0	417.0
	N	417.0	680.0
	O	680.0	1100.0
	P	1100.0	1800.0
	Q	1800.0	2700.0
	R	2700.0	4300.0
S	4300.0	6800.0	
T	6800.0	10800.0	
U	10800.0	16000.0	
V	16000.0	25000.0	
W	25000.0	40000.0	

Maximum tolerance for each bin limit is $\pm 18\%$.

Color Categories

Color	Category #	Lambda (nm)	
		Min.	Max.
Green	6	561.5	564.5
	5	564.5	567.5
	4	567.5	570.5
	3	570.5	573.5
	2	573.5	576.5
Yellow	1	582.0	584.5
	3	584.5	587.0
	2	587.0	589.5
	4	589.5	592.0
	5	592.0	593.0

Tolerance for each bin limit is ± 0.5 nm.

Mechanical Option Matrix

Mechanical Option Code	Definition
00	Bulk Packaging, minimum increment 500 pcs/bag
01	Tape & Reel, crimped leads, min. increment 1300 pcs/bag for T-1 3/4, 1800 pcs/bag for T-1
02	Tape & Reel, straight leads, min. increment 1300 pcs/bag for T-1 3/4, 1800 pcs/bag for T-1
A1	T-1, Right Angle Housing, uneven leads, minimum increment 500 pcs/bag
A2	T-1, Right Angle Housing, even leads, minimum increment 500 pcs/bag
B1	T-1 3/4, Right Angle Housing, uneven leads, minimum increment 500 pcs/bag
B2	T-1 3/4, Right Angle Housing, even leads, minimum increment 500 pcs/bag
BH	T-1, Tape & Reel, straight leads, minimum increment 2000 pcs/bag
FH	Devices that require inventory control and 2 L _v bin select
R1	Tape & Reel, crimped leads, reeled counter clockwise, cathode lead leaving the reel first

Note:

All categories are established for classification of products. Products may not be available in all categories. Please contact your local Agilent representative for further clarification/information.

www.agilent.com/semiconductors

For product information and a complete list of distributors, please go to our web site.

For technical assistance call:

Americas/Canada: +1 (800) 235-0312 or
(916) 788-6763

Europe: +49 (0) 6441 92460

China: 10800 650 0017

Hong Kong: (+65) 6756 2394

India, Australia, New Zealand: (+65) 6755 1939

Japan: (+81 3) 3335-8152(Domestic/International), or 0120-61-1280(Domestic Only)

Korea: (+65) 6755 1989

Singapore, Malaysia, Vietnam, Thailand,
Philippines, Indonesia: (+65) 6755 2044

Taiwan: (+65) 6755 1843

Data subject to change.

Copyright © 2003 Agilent Technologies, Inc.

September 10, 2003

5988-8054EN