

# AH110 / ECG014

0.2 Watt, High Linearity InGaP HBT Amplifier *Product Information*



## Product Features

- 50 – 2000 MHz
- +23 dBm P1dB
- +39 dBm Output IP3
- 20.5 dB Gain @ 900 MHz
- 17.6 dB Gain @ 1900 MHz
- Single Positive Supply (+8V)
- Available in a lead-free / green SOT-89 Package Style

## Applications

- Mobile Infrastructure
- Defense/Homeland Security

## Product Description

The AH110 / ECG014 is a high dynamic range driver amplifier in a low-cost surface mount package. The InGaP/GaAs HBT is able to achieve performance over a broad range with +39 dBm OIP3 and +23 dBm of compressed 1-dB power. It is housed in a lead-free/green/RoHS-compliant SOT-89 SMT package. All devices are 100% RF and DC tested.

The product is targeted for use as a gain block/driver amplifier for various current and next generation wireless technologies such as GPRS, GSM and CDMA, where high linearity and medium power is required. In addition, the AH110 / ECG014 will work for numerous other applications within the 50 to 2000 MHz frequency range.

## Functional Diagram

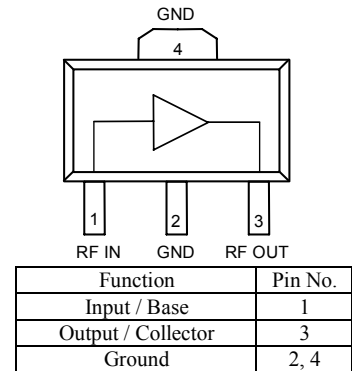

## Specifications <sup>(1)</sup>

Parameters	Units	Min	Typ	Max
Operational Bandwidth	MHz	50		2000
Test Frequency	MHz		900	
Gain	dB		20.5	
Output P1dB	dBm		+23	
Output OIP3	dBm		+39	
Test Frequency	MHz		1900	
Gain	dB	17	17.6	
Input Return Loss	dB		17	
Output Return Loss	dB		7.4	
Output P1dB	dBm		+23	
Output IP3 <sup>(2)</sup>	dBm	+36.5	+38	
IS-95A Channel Power @ -45 dBc ACPR, 1900 MHz	dBm		+16	
Noise Figure	dB		5.2	
Operating Current Range <sup>(3)</sup>	mA	85	100	135
Device Voltage <sup>(4)</sup>	V		5	

1. Test conditions unless otherwise noted: 25 °C, Vsupply = +8V, in tuned application circuit with Rbias = 30 Ω.
2. 3OIP measured with two tones at an output power of +9 dBm/tone separated by 1 MHz. The suppression on the largest IM3 product is used to calculate the 3OIP using a 2:1 rule. The tuned application circuit is tuned for optimum ACPR performance. An improvement in OIP3 of 2 to 3 dB can be achieved for tuning for optimum OIP3 (with slightly degraded ACPR performance).
3. This corresponds to the quiescent current or operating current under small-signal conditions.
4. This device requires a minimum 7 V power supply through a dropping resistor. 8 V and 30 ohms are recommended for proper operation. Operation of the device directly to a 5 V supply could lead to thermal damage to the device.

## Typical Performance <sup>(5)</sup>

Parameters	Units	Typical	
Frequency	MHz	900	1900
S21 – Gain	dB	20.5	17.6
S11 – Input R.L.	dB	-20	-17
S22 – Output R.L.	dB	-9.5	-7.4
Output P1dB	dBm	+22.8	+23
Output IP3 <sup>(2)</sup>	dBm	+39	+38
IS-95A Channel Power <sup>(6)</sup>	dBm	+17	+16
Noise Figure	dB	5	5.2
Supply Bias		+8 V @ 100 mA	

5. Typical parameters reflect performance in a tuned application circuit: Supply Voltage = +8 V, Icc = 100 mA, +25° C, Rbias = 30 Ω.
6. This is measured with an IS-95 signal at (9 ch. Fwd)–45dBc ACPR.

## Absolute Maximum Rating

Parameter	Rating
Operating Case Temperature	-40 to +85 °C
Storage Temperature	-55 to +150 °C
RF Input Power (continuous)	+15 dBm
Device Voltage	+6 V
Device Current	150 mA
Junction Temperature	+250 °C

Operation of this device above any of these parameters may cause permanent damage.

## Ordering Information

Part No.	Description
AH110-89*	InGaP HBT Gain Block (lead-tin SOT-89 Pkg)
ECG014B*	InGaP HBT Gain Block (lead-tin SOT-89 Pkg)
AH110-89G	InGaP HBT Gain Block (lead-free/green/RoHS-compliant SOT-89 Pkg)
AH110-89PCB900	900 MHz Evaluation Board
AH110-89PCB1900	1900 MHz Evaluation Board

\* This package is being phased out in favor of the green package type which is backwards compatible for existing designs. Refer to Product Change Notification WJPCN06MAY05TC1 on the WJ website.

Specifications and information are subject to change without notice

# AH110 / ECG014

0.2 Watt, High Linearity InGaP HBT Amplifier *Product Information*



## Typical Device Data

S-parameters ( $V_{device} = +5V$ ,  $I_{cc} = 100\text{ mA}$ ,  $25^\circ\text{ C}$ , unmatched 50 ohm system)

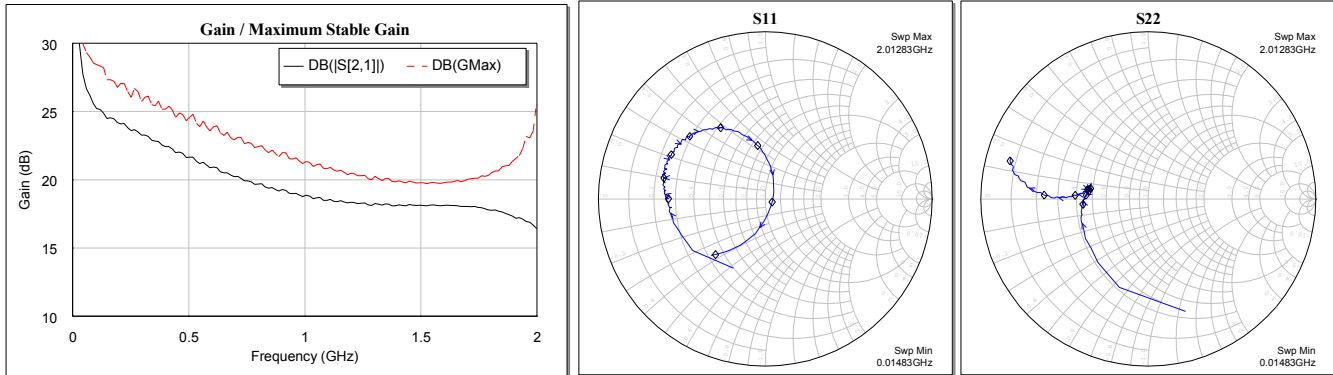

Notes:

The gain for the unmatched device in 50 ohm system is shown as the trace in blue color. For a tuned circuit for a particular frequency, it is expected that actual gain will be higher, up to the maximum stable gain. The maximum stable gain is shown in the dashed red line. The impedance plots are shown from 50 – 2500 MHz, with markers placed at 0.25 – 2 GHz in 0.25 GHz increments.

S-Parameters ( $V_{device} = +5\text{ V}$ ,  $I_{cc} = 100\text{ mA}$ ,  $T = 25^\circ\text{ C}$ , unmatched 50 ohm system, calibrated to device leads)

Freq (MHz)	S11 (dB)	S11 (ang)	S21 (dB)	S21 (ang)	S12 (dB)	S12 (ang)	S22 (dB)	S22 (ang)
50	-5.21	-158.20	27.34	141.96	-32.11	16.29	-6.58	-132.30
100	-4.92	-170.08	25.32	144.95	-31.61	9.45	-7.49	-157.02
200	-4.72	-177.73	24.15	138.50	-31.37	6.88	-7.96	-171.72
400	-4.31	173.22	22.43	118.30	-30.63	7.98	-8.46	178.73
600	-4.10	163.26	20.91	100.56	-30.32	5.52	-8.81	174.06
800	-4.19	152.57	19.68	85.04	-29.78	2.65	-9.07	171.40
1000	-4.63	140.41	18.82	69.98	-29.74	-2.18	-9.12	169.67
1200	-5.64	126.43	18.35	54.85	-29.31	-11.26	-8.95	170.98
1400	-7.84	109.08	18.13	38.12	-29.86	-26.72	-8.04	175.14
1600	-13.52	83.27	18.12	17.54	-31.16	-52.52	-6.16	179.09
1800	-19.89	-85.25	17.78	-7.75	-34.99	-105.12	-3.43	176.43
2000	-6.99	-131.98	16.44	-37.07	-34.48	161.53	-1.36	164.56
2200	-2.84	-160.75	14.09	-64.48	-29.33	106.22	-0.69	149.67
2400	-1.18	177.40	10.90	-86.11	-26.64	75.52	-0.93	136.25
2500	-0.78	167.87	9.28	-96.04	-25.96	66.16	-1.28	130.16

Device S-parameters are available for download off of the website at: <http://www.wj.com>

## Application Circuit PC Board Layout

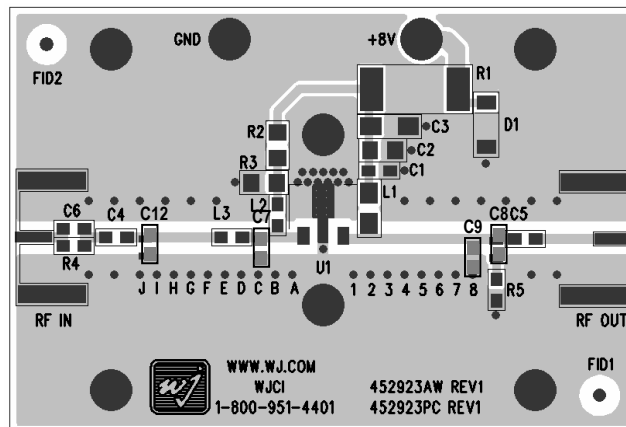

Circuit Board Material: .014" Getek, 4 - layer, 1 oz copper, Microstrip line details: width = .026", spacing = .026"

The silk screen markers 'A', 'B', 'C', etc. and '1', '2', '3', etc. are used as placemarkers for the input and output tuning shunt capacitors. The markers and vias are spaced in .050" increments.

C7/C8 are for 900 MHz matching circuits and C9/C12 are for 1900 MHz matching circuits.

Specifications and information are subject to change without notice

# AH110 / ECG014

0.2 Watt, High Linearity InGaP HBT Amplifier *Product Information*



## 900 MHz Application Circuit (AH110-89PCB900)

### Typical RF Performance at 25°C

Frequency	900 MHz
S21 – Gain	20.5 dB
S11 – Input Return Loss	-20 dB
S22 – Output Return Loss	-9.5 dB
Output P1 dB	+22.8 dBm
Output IP3* (+9 dBm / tone, 1 MHz spacing)	+39 dBm
Channel Power (@-45 dBc ACPR, IS-95 9 channels fwd)	+17 dBm
Noise Figure	5 dB
Device Voltage	+5 V
Quiescent Current	100 mA

\* Please see note 2 on page 1.

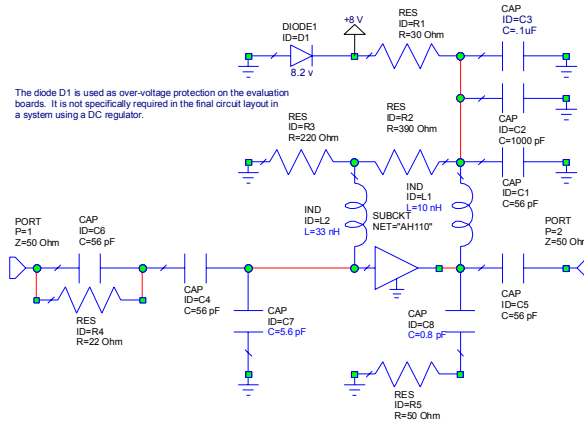

C7 is placed at silkscreen marker 'C' or center of component placed at 5.6 deg. @ 900 MHz away from pin 1. C8 is placed at 22 deg. @ 900 MHz away from pin 3.

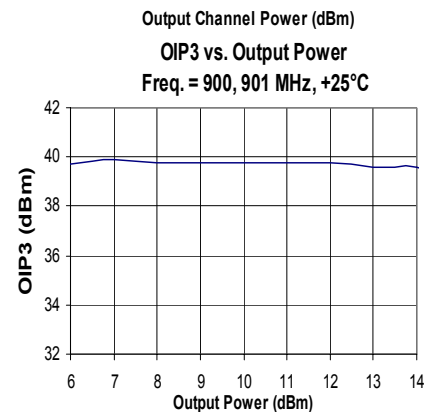
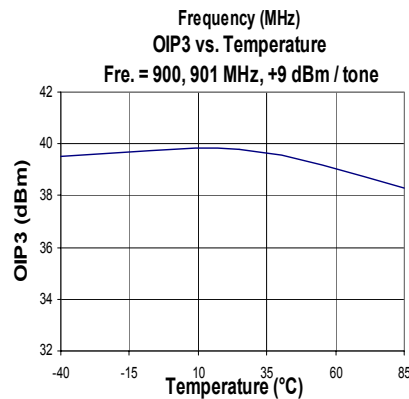
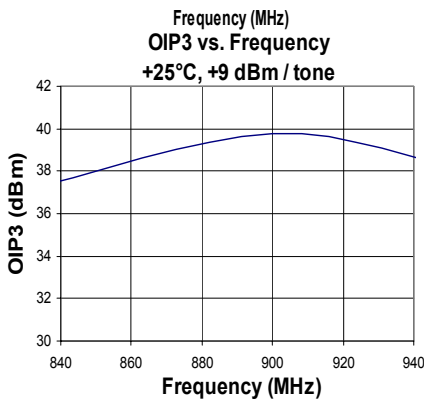
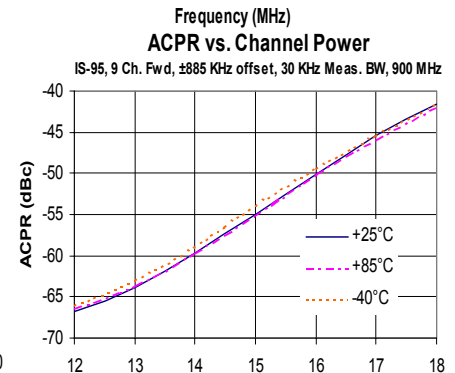
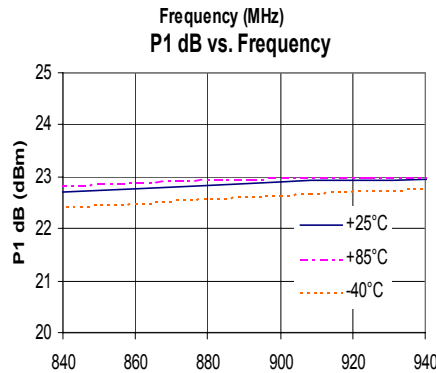
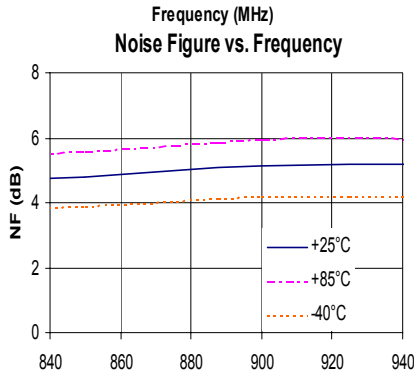
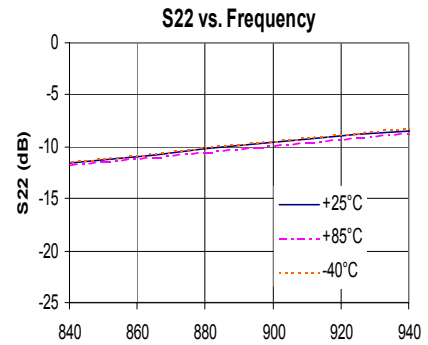
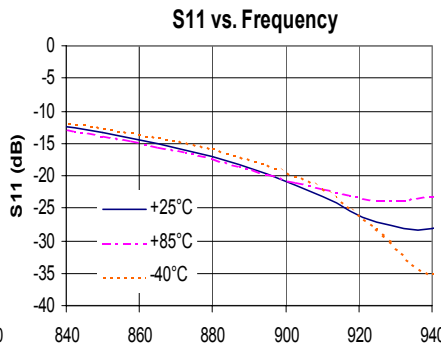
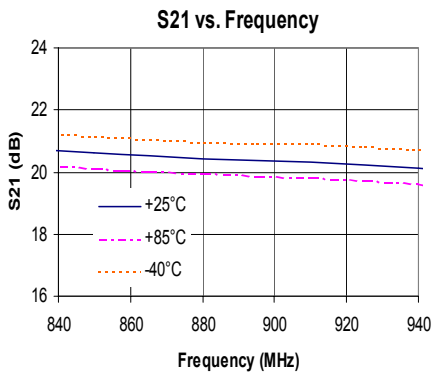

Specifications and information are subject to change without notice

# AH110 / ECG014

0.2 Watt, High Linearity InGaP HBT Amplifier *Product Information*



## 1960 MHz Application Circuit (AH110-89PCB1960)

### Typical RF Performance at 25°C

Frequency	1960 MHz
S21 – Gain	17.6 dB
S11 – Input Return Loss	-17 dB
S22 – Output Return Loss	-7.4 dB
Output P1 dB	+23 dBm
Output IP3* (+9 dBm / tone, 1 MHz spacing)	+38 dBm
Channel Power (@-45 dBc ACPR, IS-95 9 channels fwd)	+16 dBm
Noise Figure	5.2 dB
Device Voltage	+5 V
Quiescent Current	100 mA

\* Please see note 2 on page 1.

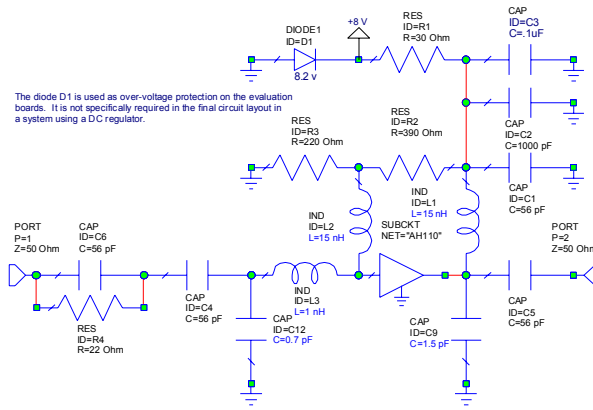

C9 placed at silkscreen marker '8' or center of component placed at 39 deg. @ 1900 MHz away from pin 1.  
C12 is placed at silkscreen marker '1' or center of component placed at 43 deg. @ 1.9 GHz away from pin 1.

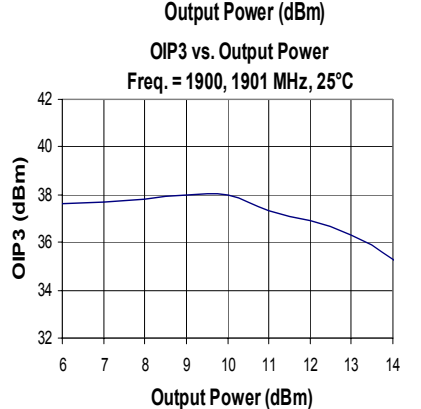
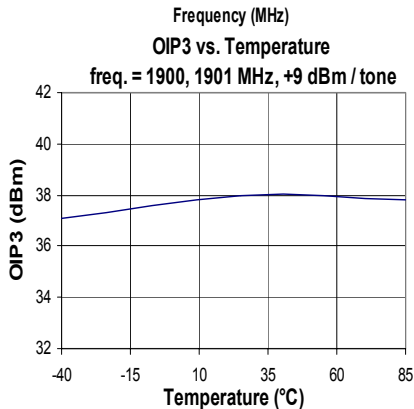
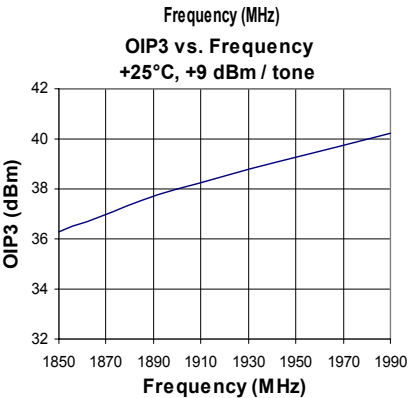
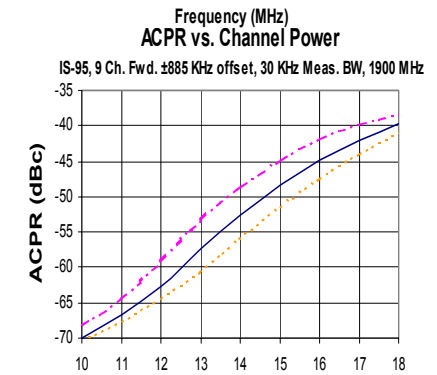
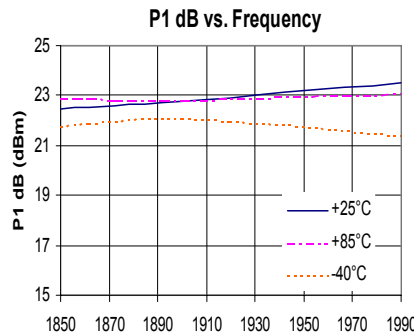
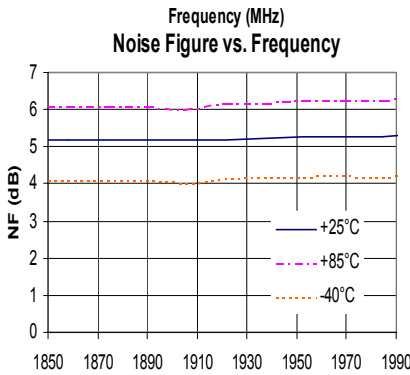
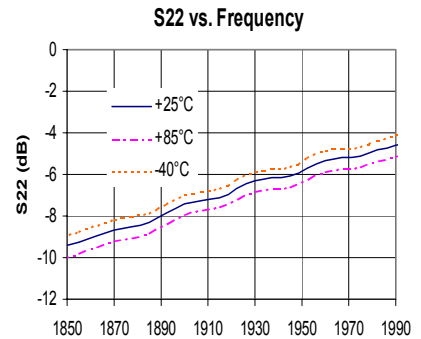
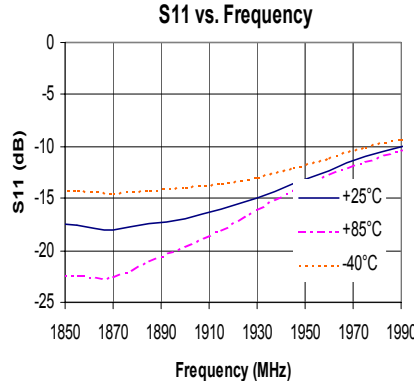
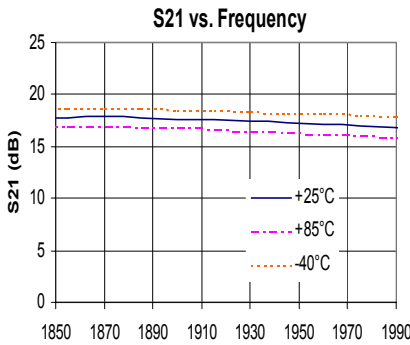

Specifications and information are subject to change without notice

# AH110 / ECG014

0.2 Watt, High Linearity InGaP HBT Amplifier

Product Information



## AH110 (SOT-89 Package) Mechanical Information

This package may contain lead-bearing materials. The plating material on the leads is

### Outline Drawing

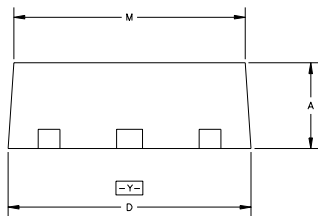
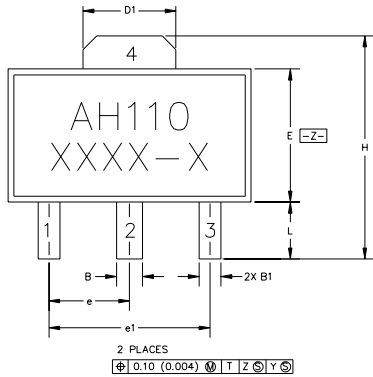

SYMBOL	MIN	MAX
A	1.40 (.055)	1.60 (.063)
B	.44 (.017)	.56 (.022)
B1	.36 (.014)	.48 (.019)
C	.35 (.014)	.44 (.017)
D	4.40 (.173)	4.60 (.181)
D1	1.62 (.064)	1.83 (.072)
E	2.29 (.079)	2.60 (.102)
E1	2.13 (.084)	2.29 (.090)
e	1.50 BSC (.059)	
e1	3.00 BSC (.118)	
H	3.94 (.155)	4.25 (.167)
L	.89 (.035)	1.20 (.047)
M	4.04 (.159)	4.19 (.165)

NOTES:

1. DIMENSIONS CONFORM WITH JEDEC TO-243C EXCEPT WHERE INDICATED.
2. DIMENSIONS ARE EXPRESSED IN MILLIMETERS.
3. DIMENSIONING AND TOLERANCING (AW ANS) Y14.5.

### Product Marking

The component will be marked with an "AH110" part number with an alphanumeric site lot code on the top surface of the package.

Tap and reel specifications for this part are located on the website in the Application Note section.

### ESD/MSL Information

**Caution:** ESD sensitive device.

Rating: Class 1B  
 Value: Resistor classes between 500 and 1000V  
 Test: Human Body Model (HBM)  
 Standard: JEDEC Standard JESD22-A114

Rating: Level 3 at +235° C convection reflow  
 Standard: JEDEC Standard J-STD-020

### Land Pattern

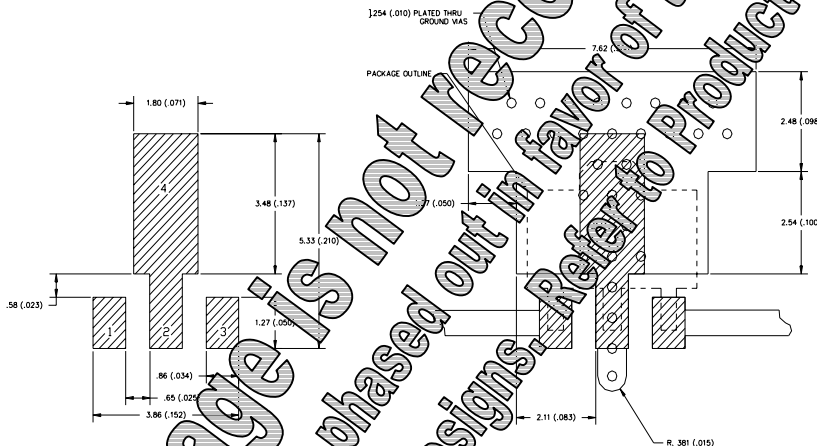

### Mounting Config. Notes

1. Ground / thermal vias are critical for the proper performance of this device. Vias should use a .35mm (#80 / .0135") diameter drill and have a final plated thru diameter of .25 mm (.010").
2. Add as much copper as possible to inner and outer layers near the part to ensure optimal thermal performance.
3. Mounting screws can be added near the part to fasten the board to a heatsink. Ensure that the ground / thermal via region contacts the heatsink.
4. Do not put solder mask on the backside of the PC board in the region where the board contacts the heatsink.
5. RF trace width depends upon the PC board material and construction.
6. Use 1 oz. Copper minimum.
7. All dimensions are in millimeters (inches). Angles are in degrees.

### Thermal Specifications

Parameter	Symbol	Value
Operating Temperature	T <sub>op</sub>	-40 to +85° C
Thermal Resistance, (1)	θ <sub>JA</sub>	8° C / W
Junction Temperature, T <sub>j</sub>	T <sub>j</sub>	149° C

The thermal performance is referenced from the junction-temperature rise at a case temperature of 85° C. This corresponds to the typical biasing condition of +5V, 100mA at 25° C case temperature. A minimum MTT of one million hours is achieved for junction temperatures below 247° C.

Specifications and information are subject to change without notice

# AH110 / ECG014

0.2 Watt, High Linearity InGaP HBT Amplifier *Product Information*



## AH110-89G (Green / Lead-free SOT-89 Package) Mechanical Information

This package is lead-free/Green/RoHS-compliant. It is compatible with both lead-free (maximum 260°C reflow temperature) and leaded (maximum 245°C reflow temperature) soldering processes. The plating material on the leads is NiPdAu.

### Outline Drawing

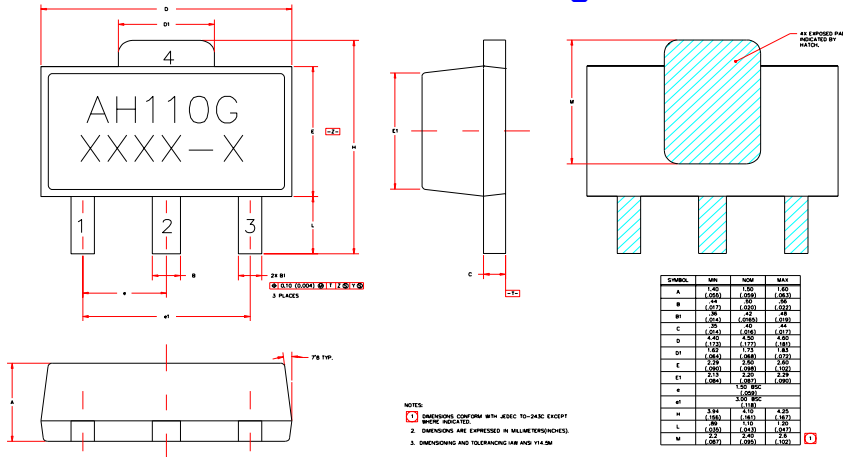

### Product Marking

The component will be marked with an "AH110G" designator with an alphanumeric lot code on the top surface of the package.

Tape and reel specifications for this part are located on the website in the "Application Notes" section.

### MSL / ESD Rating



Caution! ESD sensitive device.

ESD Rating: Class 1A  
 Value: Passes between 250 and 500V  
 Test: Human Body Model (HBM)  
 Standard: JEDEC Standard JESD22-A114

MSL Rating: Level 3 at +260° C convection reflow  
 Standard: JEDEC Standard J-STD-020

### Land Pattern

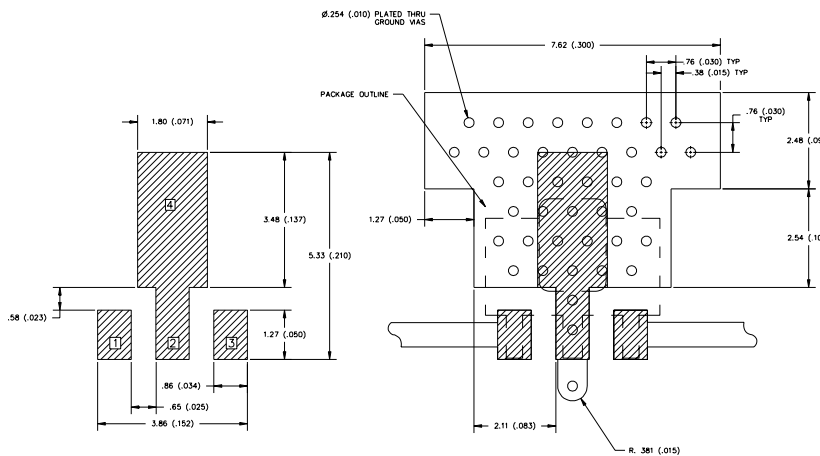

### Mounting Config. Notes

- Ground / thermal vias are critical for the proper performance of this device. Vias should use a .35mm (#80 / .0135") diameter drill and have a final plated thru diameter of .25 mm (.010").
- Add as much copper as possible to inner and outer layers near the part to ensure optimal thermal performance.
- Mounting screws can be added near the part to fasten the board to a heatsink. Ensure that the ground / thermal via region contacts the heatsink.
- Do not put solder mask on the backside of the PC board in the region where the board contacts the heatsink.
- RF trace width depends upon the PC board material and construction.
- Use 1 oz. Copper minimum.
- All dimensions are in millimeters (inches). Angles are in degrees.

### Thermal Specifications

Parameter	Rating
Operating Case Temperature	-40 to +85° C
Thermal Resistance, Rth <sup>(1)</sup>	128° C / W
Junction Temperature, Tjc <sup>(2)</sup>	149° C

Notes:

- The thermal resistance is referenced from the junction-to-case at a case temperature of 85° C.
- This corresponds to the typical biasing condition of +5V, 100 mA at an 85° C case temperature. A minimum MTTF of 1 million hours is achieved for junction temperatures below 247° C.

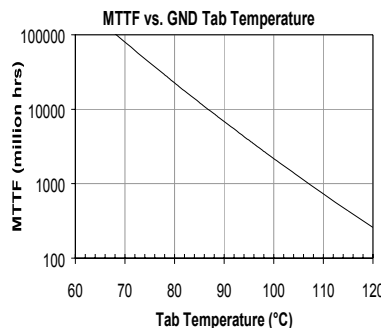

Specifications and information are subject to change without notice



# AH110 / ECG014

0.2 Watt, High Linearity InGaP HBT Amplifier

Product Information



## ECG014B (SOT-89 Package) Mechanical Information

This package may contain lead-bearing materials. The plating material on the leads is Sn.

### Outline Drawing

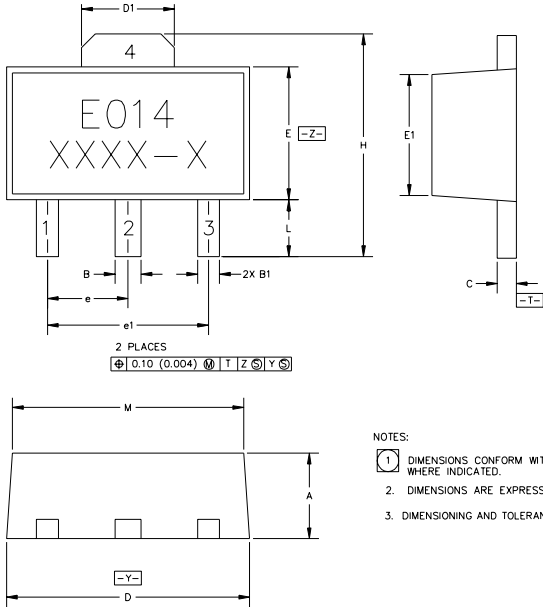

SYMBOL	MIN	MAX
A	1.40 (.055)	1.60 (.063)
B	.44 (.017)	.56 (.022)
B1	.36 (.014)	.48 (.019)
C	.35 (.014)	.44 (.017)
D	4.40 (.173)	4.60 (.181)
D1	1.52 (.064)	1.83 (.072)
E	2.29 (.079)	2.60 (.102)
E1	2.13 (.084)	2.29 (.090)
e	1.50 BSC (.059)	
e1	3.00 BSC (.118)	
H	3.94 (.155)	4.25 (.167)
L	.89 (.035)	1.20 (.047)
M	4.04 (.159)	4.19 (.165)

NOTES:

1. DIMENSIONS CONFORM WITH JEDEC TO-243C EXCEPT WHERE INDICATED.
2. DIMENSIONS ARE EXPRESSED IN MILLIMETERS(INCHES).
3. DIMENSIONING AND TOLERANCING IAW ANSI Y14.5.

### Product Marking

The component is marked with an alphanumeric designator with the alphanumeric lot code on the top surface of the package.

Tape reel specifications for this part are located in the table in Application Note Section.

### ESD/MSL Information

Caution: ESD sensitive device.

Rating: Level 1B

Value: 1000 cycles between 500 and 1000V

Test: Human Body Model (HBM)

Standard: JEDEC Standard JESD22-A114

MSL Rating: Level 3 at +235° C convection reflow

Standard: JEDEC Standard J-STD-020

### Mounting Config. Notes

1. Ground / thermal vias are critical for the proper performance of this device. Vias should use a .35mm (#80 / .0135") diameter drill and have a final plated thru diameter of .25 mm (.010").
2. Add as much copper as possible to inner and outer layers near the part to ensure optimal thermal performance.
3. Mounting screws can be added near the part to fasten the board to a heatsink. Ensure that the ground / thermal via region contacts the heatsink.
4. Do not put solder mask on the backside of the PC board in the region where the board contacts the heatsink.
5. RF trace width depends upon the PC board material and construction.
6. Use 1 oz. Copper minimum.
7. All dimensions are in millimeters (inches). Angles are in degrees.

### Land Pattern

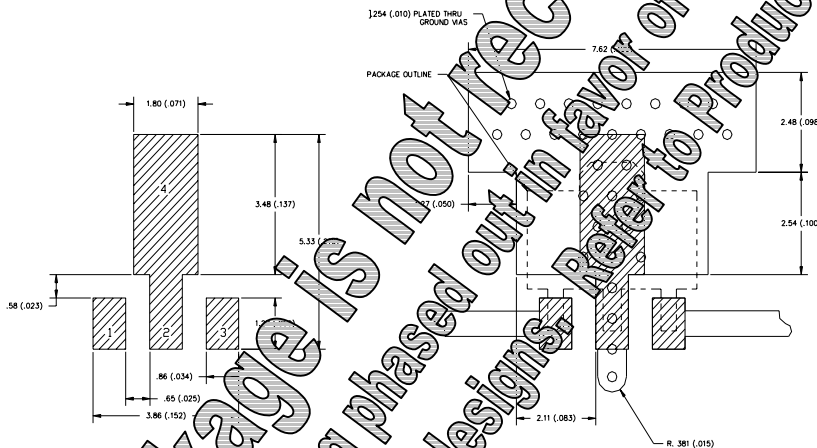

### Thermal Specifications

Parameter	Typical Value	Unit
Operating Temperature	+85	°C
Thermal Resistance, R <sub>th(j-c)</sub>	1.5	°C / W
Junction Temperature	149	°C

The thermal resistance is referenced from the junction to case at a case temperature of 85° C.

1. This corresponds to the typical biasing condition of +5V, 100 mA at 85° C case temperature. A minimum MTF of 1 million hours is achieved for junction temperatures below 247° C.

Specifications and information are subject to change without notice