

AD7440/AD7450A

FEATURES

Fast throughput rate: 1 MSPS

Specified for V_{DD} of 3 V and 5 V

Low power at max throughput rate:

4 mW max at 1 MSPS with 3 V supplies

9.25 mW max at 1 MSPS with 5 V supplies

Fully differential analog input

Wide input bandwidth:

70 dB SINAD at 100 kHz input frequency

Flexible power/serial clock speed management

No pipeline delays

High speed serial interface:

SPI[®]/QSPI[™]/MICROWIRE[™]/DSP compatible

Power-down mode: 1 μ A max

8-lead SOT-23 and MSOP packages

APPLICATIONS

Transducer interface

Battery-powered systems

Data acquisition systems

Portable instrumentation

Motor control

GENERAL DESCRIPTION

The AD7440/AD7450A¹ are 10-bit and 12-bit high speed, low power, successive approximation (SAR) analog-to-digital converters with a fully differential analog input. These parts operate from a single 3 V or 5 V power supply and use advanced design techniques to achieve very low power dissipation at throughput rates up to 1 MSPS. The SAR architecture of these parts ensures that there are no pipeline delays.

The parts contain a low noise, wide bandwidth, differential track-and-hold amplifier (T/H) that can handle input frequencies up to 3.5 MHz. The reference voltage is applied externally to the V_{REF} pin and can be varied from 100 mV to 3.5 V depending on the power supply and what suits the application. The value of the reference voltage determines the common-mode voltage range of the part. With this truly differential input structure and variable reference input, the user can select a variety of input ranges and bias points.

The conversion process and data acquisition are controlled using \overline{CS} and the serial clock, allowing the device to interface with microprocessors or DSPs. The input signals are sampled

Rev. B

Information furnished by Analog Devices is believed to be accurate and reliable. However, no responsibility is assumed by Analog Devices for its use, nor for any infringements of patents or other rights of third parties that may result from its use. Specifications subject to change without notice. No license is granted by implication or otherwise under any patent or patent rights of Analog Devices. Trademarks and registered trademarks are the property of their respective owners.

FUNCTIONAL BLOCK DIAGRAM

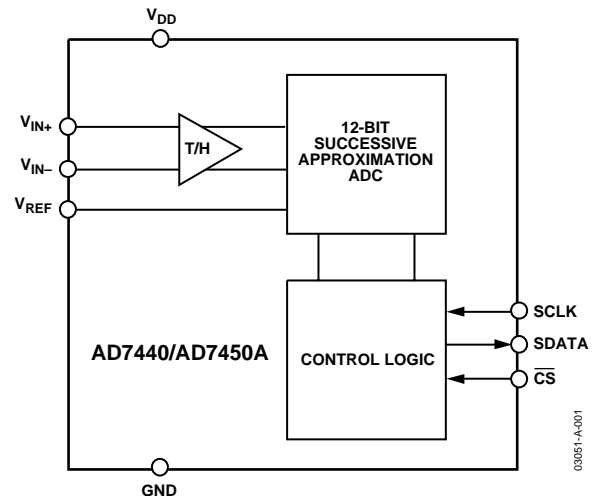

Figure 1.

on the falling edge of \overline{CS} ; the conversion is also initiated at this point. The SAR architecture of these parts ensures that there are no pipeline delays. The AD7440 and the AD7450A use advanced design techniques to achieve very low power dissipation at high throughput rates.

PRODUCT HIGHLIGHTS

1. Operation with either 3 V or 5 V power supplies.
2. High throughput with low power consumption. With a 3 V supply, the AD7440/AD7450A offer 4 mW max power consumption for 1 MSPS throughput.
3. Fully differential analog input.
4. Flexible power/serial clock speed management. The conversion rate is determined by the serial clock, allowing the power to be reduced as the conversion time is reduced through the serial clock speed increase. These parts also feature a shutdown mode to maximize power efficiency at lower throughput rates.
5. Variable voltage reference input.
6. No pipeline delay.
7. Accurate control of the sampling instant via a \overline{CS} input and once-off conversion control.
8. ENOB > eight bits typically with 100 mV reference.

¹ Protected by U.S. Patent Number 6,681,332.

TABLE OF CONTENTS

AD7440—Specifications.....	3	Digital Inputs	20
AD7450A—Specifications.....	5	Reference	20
Timing Specifications.....	7	Single-Ended Operation.....	20
Absolute Maximum Ratings.....	8	Serial Interface	21
ESD Caution.....	8	Modes of Operation	23
Pin Configurations and Function Descriptions	9	Normal Mode.....	23
Terminology	10	Power-Down Mode.....	23
AD7440/AD7450A—Typical Performance Characteristics	12	Power-Up Time	24
Circuit Information	15	Power vs. Throughput Rate.....	24
Converter Operation.....	15	Microprocessor and DSP Interfacing	25
ADC Transfer Function.....	15	Grounding and Layout Hints.....	26
Typical Connection Diagram	16	Evaluating the AD7440/AD7450A Performance	26
Analog Input	16	Outline Dimensions.....	27
Driving Differential Inputs.....	18	Ordering Guide.....	28

REVISION HISTORY

2/04—Data Sheet changed from Rev. A to Rev. B

Added Patent Note	1
-------------------------	---

1/04—Data Sheet changed from Rev. 0 to Rev. A

Updated Format.....	Universal
Changes to General Description	1
Changes to Table 1 footnotes	3
Changes to Table 2 footnotes	5
Changes to Table 3 footnotes	7

AD7440—SPECIFICATIONS

Table 1. $V_{DD} = 2.7\text{ V to }3.6\text{ V}$, $f_{SCLK} = 18\text{ MHz}$, $f_s = 1\text{ MSPS}$, $V_{REF} = 2.0\text{ V}$; $V_{DD} = 4.75\text{ V to }5.25\text{ V}$, $f_{SCLK} = 18\text{ MHz}$, $f_s = 1\text{ MSPS}$, $V_{REF} = 2.5\text{ V}$; $V_{CM}^1 = V_{REF}$; $T_A = T_{MIN}$ to T_{MAX} , unless otherwise noted. Temperature range for B Version $-40^\circ\text{C to }+85^\circ\text{C}$.

Parameter	Test Conditions/Comments	B Version	Unit
DYNAMIC PERFORMANCE			
Signal-to-(Noise + Distortion) (SINAD) ²	$f_{IN} = 100\text{ kHz}$	61	dB min
Total Harmonic Distortion (THD) ²	-82 dB typ	-74	dB max
Peak Harmonic or Spurious Noise ²	-82 dB typ	-76	dB max
Intermodulation Distortion (IMD) ²	$f_a = 90\text{ kHz}$, $f_b = 110\text{ kHz}$		
Second-Order Terms		-83	dB typ
Third-Order Terms		-83	dB typ
Aperture Delay ²		5	ns typ
Aperture Jitter ²		50	ps typ
Full Power Bandwidth ^{2, 3}	@ -3 dB	20	MHz typ
	@ -0.1 dB	2.5	MHz typ
DC ACCURACY			
Resolution		10	Bits
Integral Nonlinearity (INL) ²		± 0.5	LSB max
Differential Nonlinearity (DNL) ²	Guaranteed no missed codes to 10 bits	± 0.5	LSB max
Zero-Code Error ²		± 2.5	LSB max
Positive Gain Error ²		± 1	LSB max
Negative Gain Error ²		± 1	LSB max
ANALOG INPUT			
Full-Scale Input Span	$2 \times V_{REF}^4$	$V_{IN+} - V_{IN-}$	V
Absolute Input Voltage			
V_{IN+}	$V_{CM} = V_{REF}$	$V_{CM} \pm V_{REF}/2$	V
V_{IN-}	$V_{CM} = V_{REF}$	$V_{CM} \pm V_{REF}/2$	V
DC Leakage Current		± 1	$\mu\text{A max}$
Input Capacitance	When in track-and-hold	30/10	pF typ
REFERENCE INPUT			
V_{REF} Input Voltage	$V_{DD} = 4.75\text{ V to }5.25\text{ V}$ ($\pm 1\%$ tolerance for specified performance)	2.5 ⁵	V
	$V_{DD} = 2.7\text{ V to }3.6\text{ V}$ ($\pm 1\%$ tolerance for specified performance)	2.0 ⁶	V
DC Leakage Current		± 1	$\mu\text{A max}$
V_{REF} Input Capacitance	When in track-and-hold	10/30	pF typ
LOGIC INPUTS			
Input High Voltage, V_{INH}		2.4	V min
Input Low Voltage, V_{INL}		0.8	V max
Input Current, I_{IN}	Typically 10 nA, $V_{IN} = 0\text{ V or }V_{DD}$	± 1	$\mu\text{A max}$
Input Capacitance, C_{IN}^7		10	pF max
LOGIC OUTPUTS			
Output High Voltage, V_{OH}	$V_{DD} = 4.75\text{ V to }5.25\text{ V}$; $I_{SOURCE} = 200\text{ }\mu\text{A}$	2.8	V min
	$V_{DD} = 2.7\text{ V to }3.6\text{ V}$; $I_{SOURCE} = 200\text{ }\mu\text{A}$	2.4	V min
Output Low Voltage, V_{OL}	$I_{SINK} = 200\text{ }\mu\text{A}$	0.4	V max
Floating-State Leakage Current		± 1	$\mu\text{A max}$
Floating-State Output Capacitance ⁷		10	pF max
Output Coding		Twos Complement	

AD7440/AD7450A

Parameter	Test Conditions/Comments	B Version	Unit
CONVERSION RATE			
Conversion Time	888 ns with an 18 MHz SCLK	16	SCLK cycles
Track-and-Hold Acquisition Time ²	Sine wave input	200	ns max
	Step input	290	ns max
Throughput Rate		1	MSPS max
POWER REQUIREMENTS			
V _{DD}	Range: 3 V + 20%/–10%; 5 V ± 5%	2.7/5.25	V min/V max
I _{DD} ⁸			
Normal Mode (Static)	SCLK on or off	0.5	mA typ
Normal Mode (Operational)	V _{DD} = 4.75 V to 5.25 V	1.95	mA max
	V _{DD} = 2.7 V to 3.6 V	1.45	mA max
Full Power-Down Mode	SCLK on or off	1	μA max
Power Dissipation			
Normal Mode (Operational)	V _{DD} = 5 V, 1.55 mW typ for 100 kSPS ⁹	9.25	mW max
	V _{DD} = 3 V, 0.6 mW typ for 100 kSPS ⁹	4	mW max
Full Power-Down	V _{DD} = 5 V, SCLK on or off	5	μW max
	V _{DD} = 3 V, SCLK on or off	3	μW max

¹ Common-mode voltage. The input signal can be centered on a dc common-mode voltage in the range specified in Figure 28 and Figure 29.

² See Terminology section.

³ Analog inputs with slew rates exceeding 27 V/μs (full-scale input sine wave > 3.5 MHz) within the acquisition time may cause the converter to return an incorrect result.

⁴ Because the input spans of V_{IN+} and V_{IN-} are both V_{REF} and are 180° out of phase, the differential voltage is 2 × V_{REF}.

⁵ The AD7440 is functional with a reference input from 100 mV and for V_{DD} = 5 V; the reference can range up to 3.5 V.

⁶ The AD7440 is functional with a reference input from 100 mV and for V_{DD} = 3 V; the reference can range up to 2.2 V.

⁷ Guaranteed by characterization.

⁸ Measured with a midscale dc input.

⁹ See Power vs. Throughput section.

AD7450A—SPECIFICATIONS

Table 2. $V_{DD} = 2.7\text{ V to }3.6\text{ V}$, $f_{SCLK} = 18\text{ MHz}$, $f_s = 1\text{ MSPS}$, $V_{REF} = 2.0\text{ V}$; $V_{DD} = 4.75\text{ V to }5.25\text{ V}$, $f_{SCLK} = 18\text{ MHz}$, $f_s = 1\text{ MSPS}$, $V_{REF} = 2.5\text{ V}$; $V_{CM}^1 = V_{REF}$; $T_A = T_{MIN}$ to T_{MAX} , unless otherwise noted. Temperature range for B Version $-40^\circ\text{C to }+85^\circ\text{C}$.

Parameter	Test Conditions/Comments	B Version	Unit
DYNAMIC PERFORMANCE			
Signal-to-(Noise + Distortion) (SINAD) ²	$f_{IN} = 100\text{ kHz}$	70	dB min
Total Harmonic Distortion (THD) ²	$V_{DD} = 4.75\text{ V to }5.25\text{ V}$, -86 dB typ	-76	dB max
	$V_{DD} = 2.7\text{ V to }3.6\text{ V}$, -84 dB typ	-74	dB max
Peak Harmonic or Spurious Noise ²	$V_{DD} = 4.75\text{ V to }5.25\text{ V}$, -86 dB typ	-76	dB max
	$V_{DD} = 2.7\text{ V to }3.6\text{ V}$, -84 dB typ	-74	dB max
Intermodulation Distortion (IMD) ²	$f_a = 90\text{ kHz}$, $f_b = 110\text{ kHz}$		
Second-Order Terms		-89	dB typ
Third-Order Terms		-89	dB typ
Aperture Delay ²		5	ns typ
Aperture Jitter ²		50	ps typ
Full Power Bandwidth ^{2,3}	@ -3 dB	20	MHz typ
	@ -0.1 dB	2.5	MHz typ
DC ACCURACY			
Resolution		12	Bits
Integral Nonlinearity (INL) ²		± 1	LSB max
Differential Nonlinearity (DNL) ²	Guaranteed no missed codes to 12 bits	± 0.95	LSB max
Zero-Code Error ²		± 6	LSB max
Positive Gain Error ²		± 2	LSB max
Negative Gain Error ²		± 2	LSB max
ANALOG INPUT			
Full-Scale Input Span	$2 \times V_{REF}^4$	$V_{IN+} - V_{IN-}$	V
Absolute Input Voltage			
V_{IN+}	$V_{CM} = V_{REF}$	$V_{CM} \pm V_{REF}/2$	V
V_{IN-}	$V_{CM} = V_{REF}$	$V_{CM} \pm V_{REF}/2$	V
DC Leakage Current		± 1	$\mu\text{A max}$
Input Capacitance	When in track-and-hold	30/10	pF typ
REFERENCE INPUT			
V_{REF} Input Voltage	$V_{DD} = 4.75\text{ V to }5.25\text{ V}$ ($\pm 1\%$ tolerance for specified performance)	2.5 ⁵	V
	$V_{DD} = 2.7\text{ V to }3.6\text{ V}$ ($\pm 1\%$ tolerance for specified performance)	2.0 ⁶	V
DC Leakage Current		± 1	$\mu\text{A max}$
V_{REF} Input Capacitance	When in track-and-hold	10/30	pF typ
LOGIC INPUTS			
Input High Voltage, V_{INH}		2.4	V min
Input Low Voltage, V_{INL}		0.8	V max
Input Current, I_{IN}	Typically 10 nA , $V_{IN} = 0\text{ V or }V_{DD}$	± 1	$\mu\text{A max}$
Input Capacitance, C_{IN}^7		10	pF max
LOGIC OUTPUTS			
Output High Voltage, V_{OH}	$V_{DD} = 4.75\text{ V to }5.25\text{ V}$; $I_{SOURCE} = 200\text{ }\mu\text{A}$	2.8	V min
	$V_{DD} = 2.7\text{ V to }3.6\text{ V}$; $I_{SOURCE} = 200\text{ }\mu\text{A}$	2.4	V min
Output Low Voltage, V_{OL}	$I_{SINK} = 200\text{ }\mu\text{A}$	0.4	V max
Floating-State Leakage Current		± 1	$\mu\text{A max}$
Floating-State Output Capacitance ⁷		10	pF max
Output Coding		Twos Complement	

AD7440/AD7450A

Parameter	Test Conditions/Comments	B Version	Unit
CONVERSION RATE			
Conversion Time	888 ns with an 18 MHz SCLK	16	SCLK cycles
Track-and-Hold Acquisition Time ²	Sine wave input	200	ns max
	Step input	290	ns max
Throughput Rate		1	MSPS max
POWER REQUIREMENTS			
V _{DD}	Range: 3 V + 20%/–10%; 5 V ± 5%	2.7/5.25	V min/V max
I _{DD} ⁸			
Normal Mode (Static)	SCLK on or off	0.5	mA typ
Normal Mode (Operational)	V _{DD} = 4.75 V to 5.25 V	1.95	mA max
	V _{DD} = 2.7 V to 3.6 V	1.45	mA max
Full Power-Down Mode	SCLK on or off	1	μA max
Power Dissipation			
Normal Mode (Operational)	V _{DD} = 5 V, 1.55 mW typ for 100 kSPS ⁹	9.25	mW max
	V _{DD} = 3 V, 0.6 mW typ for 100 kSPS ⁹	4	mW max
Full Power-Down	V _{DD} = 5 V, SCLK on or off	5	μW max
	V _{DD} = 3 V, SCLK on or off	3	μW max

¹ Common-mode voltage. The input signal can be centered on a dc common-mode voltage in the range specified in Figure 28 and Figure 29.

² See Terminology section.

³ Analog inputs with slew rates exceeding 27 V/μs (full-scale input sine wave > 3.5 MHz) within the acquisition time may cause the converter to return an incorrect result.

⁴ Because the input spans of V_{IN+} and V_{IN-} are both V_{REF} and are 180° out of phase, the differential voltage is 2 × V_{REF}.

⁵ The AD7450A is functional with a reference input from 100 mV and for V_{DD} = 5 V; the reference can range up to 3.5 V.

⁶ The AD7450A is functional with a reference input from 100 mV and for V_{DD} = 3 V; the reference can range up to 2.2 V.

⁷ Guaranteed by characterization.

⁸ Measured with a midscale dc input.

⁹ See Power vs. Throughput section.

TIMING SPECIFICATIONS

Guaranteed by characterization. All input signals are specified with $t_r = t_f = 5$ ns (10% to 90% of V_{DD}) and timed from a voltage level of 1.6 V. See Figure 2, Figure 3, and the Serial Interface section.

Table 3. $V_{DD} = 2.7$ V to 3.6 V, $f_{SCLK} = 18$ MHz, $f_S = 1$ MSPS, $V_{REF} = 2.0$ V; $V_{DD} = 4.75$ V to 5.25 V, $f_{SCLK} = 18$ MHz, $f_S = 1$ MSPS, $V_{REF} = 2.5$ V; $V_{CM}^1 = V_{REF}$; $T_A = T_{MIN}$ to T_{MAX} , unless otherwise noted.

Parameter	Limit at T_{MIN} , T_{MAX}	Unit	Description
f_{SCLK}^2	10 18	kHz min MHz max	
$t_{CONVERT}$	$16 \times t_{SCLK}$ 888	ns max	$t_{SCLK} = 1/f_{SCLK}$
t_{QUIET}	60	ns min	Minimum quiet time between the end of a serial read and the next falling edge of \overline{CS}
t_1	10	ns min	Minimum \overline{CS} pulse width
t_2	10	ns min	\overline{CS} falling edge to SCLK falling edge setup time
t_3^3	20	ns max	Delay from \overline{CS} falling edge until SDATA three-state disabled
t_4^3	40	ns max	Data access time after SCLK falling edge
t_5	$0.4 t_{SCLK}$	ns min	SCLK high pulse width
t_6	$0.4 t_{SCLK}$	ns min	SCLK low pulse width
t_7	10	ns min	SCLK edge to data valid hold time
t_8^4	10	ns min	SCLK falling edge to SDATA three-state enabled
	35	ns max	SCLK falling edge to SDATA three-state enabled
$t_{POWER-UP}^5$	1	μ s max	Power-up time from full power-down

¹ Common-mode voltage.

² Mark/space ratio for the SCLK input is 40/60 to 60/40.

³ Measured with the load circuit of Figure 4 and defined as the time required for the output to cross 0.8 V or 2.4 V with $V_{DD} = 5$ V or 0.4 V or 2.0 V for $V_{DD} = 3$ V.

⁴ t_8 is derived from the measured time taken by the data outputs to change 0.5 V when loaded with the circuit of Figure 4. The measured number is then extrapolated back to remove the effects of charging or discharging the 25 pF capacitor. This means that the time, t_8 , quoted in the Timing Specifications is the true bus relinquish time of the part and is independent of the bus loading.

⁵ See Power-Up Time section.

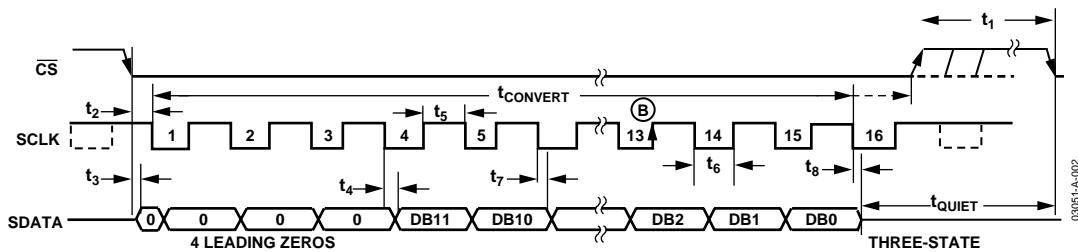

Figure 2. AD7450A Serial Interface Timing Diagram

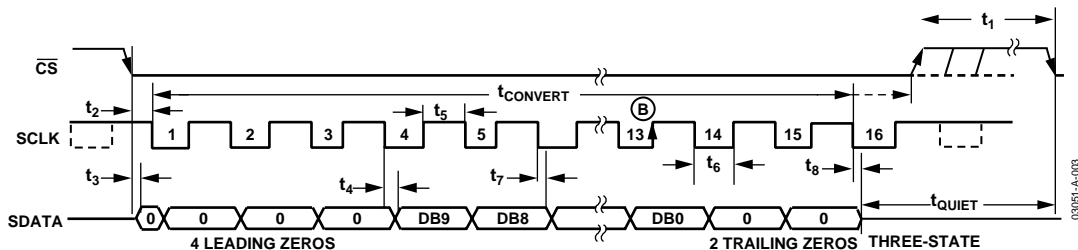

Figure 3. AD7440 Serial Interface Timing Diagram

ABSOLUTE MAXIMUM RATINGS

T_A = 25°C, unless otherwise noted.

Table 4.

Parameter	Rating
V _{DD} to GND	−0.3 V to +7 V
V _{IN+} to GND	−0.3 V to V _{DD} + 0.3 V
V _{IN−} to GND	−0.3 V to V _{DD} + 0.3 V
Digital Input Voltage to GND	−0.3 V to +7 V
Digital Output Voltage to GND	−0.3 V to V _{DD} + 0.3 V
V _{REF} to GND	−0.3 V to V _{DD} + 0.3 V
Input Current to Any Pin Except Supplies ¹	±10 mA
Operating Temperature Range	
Commercial (B Version)	−40°C to +85°C
Storage Temperature Range	−65°C to +150°C
Junction Temperature	150°C
θ _{JA} Thermal Impedance	
MSOP	205.9°C/W
SOT-23	211.5°C/W
θ _{JC} Thermal Impedance	
MSOP	43.74°C/W
SOT-23	91.99°C/W
Lead Temperature, Soldering	
Vapor Phase (60 secs)	215°C
Infrared (15 secs)	220°C
ESD	1 kV

Stresses above those listed under Absolute Maximum Ratings may cause permanent damage to the device. This is a stress rating only; functional operation of the device at these or any other conditions above those listed in the operational sections of this specification is not implied. Exposure to absolute maximum rating conditions for extended periods may affect device reliability.

¹ Transient currents of up to 100 mA do not cause SCR latch up.

ESD CAUTION

ESD (electrostatic discharge) sensitive device. Electrostatic charges as high as 4000 V readily accumulate on the human body and test equipment and can discharge without detection. Although this product features proprietary ESD protection circuitry, permanent damage may occur on devices subjected to high energy electrostatic discharges. Therefore, proper ESD precautions are recommended to avoid performance degradation or loss of functionality.

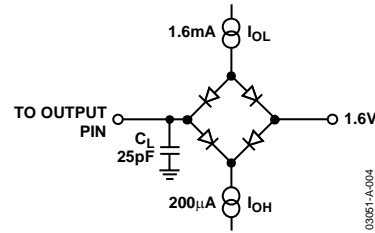

Figure 4. Load Circuit for Digital Output Timing Specifications



PIN CONFIGURATIONS AND FUNCTION DESCRIPTIONS

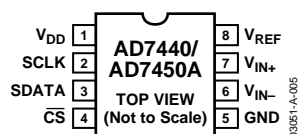

Figure 5. Pin Configuration for 8-Lead SOT-23

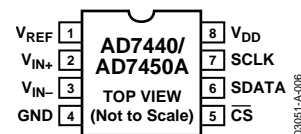

Figure 6. Pin Configuration for 8-Lead MSOP

Table 5. Pin Function Descriptions

Mnemonic	Function
V_{REF}	Reference Input for the AD7440/AD7450A. An external reference must be applied to this input. For a 5 V power supply, the reference is 2.5 V ($\pm 1\%$) for specified performance. For a 3 V power supply, the reference is 2 V ($\pm 1\%$) for specified performance. This pin should be decoupled to GND with a capacitor of at least 0.1 μF . See the Reference section for more details.
V_{IN+}	Positive Terminal for Differential Analog Input.
V_{IN-}	Negative Terminal for Differential Analog Input.
GND	Analog Ground. Ground reference point for all circuitry on the AD7440/AD7450A. All analog input signals and any external reference signal should be referred to this GND voltage.
$\overline{\text{CS}}$	Chip Select. Active low logic input. This input provides the dual function of initiating a conversion on the AD7440/AD7450A and framing the serial data transfer.
SDATA	Serial Data. Logic output. The conversion result from the AD7440/AD7450A is provided on this output as a serial data stream. The bits are clocked out on the falling edge of the SCLK input. The data stream of the AD7450A consists of four leading zeros followed by the 12 bits of conversion data, which are provided MSB first; the data stream of the AD7440 consists of four leading zeros, followed by the 10 bits of conversion data, followed by two trailing zeros. In both cases, the output coding is twos complement.
SCLK	Serial Clock. Logic input. SCLK provides the serial clock for accessing data from the part. This clock input is also used as the clock source for the conversion process.
V_{DD}	Power Supply Input. V_{DD} is 3 V (+20%/−10%) or 5 V ($\pm 5\%$). This supply should be decoupled to GND with a 0.1 μF capacitor and a 10 μF tantalum capacitor in parallel.

TERMINOLOGY

Signal-to-(Noise + Distortion) Ratio

This is the measured ratio of signal to (noise + distortion) at the output of the ADC. The signal is the rms amplitude of the fundamental. Noise is the sum of all nonfundamental signals up to half the sampling frequency ($f_s/2$), excluding dc. The ratio is dependent on the number of quantization levels in the digitization process; the more levels, the smaller the quantization noise. The theoretical signal-to-(noise + distortion) ratio for an ideal N-bit converter with a sine wave input is given by the following:

$$\text{Signal-to-(Noise + Distortion)} = (6.02N + 1.76)\text{dB.}$$

Thus for a 12-bit converter, this is 74 dB; and for a 10-bit converter, this is 62 dB.

Total Harmonic Distortion (THD)

THD is the ratio of the rms sum of harmonics to the fundamental. For the AD7440/AD7450A, it is defined as

$$\text{THD(dB)} = 20 \log \frac{\sqrt{V_2^2 + V_3^2 + V_4^2 + V_5^2 + V_6^2}}{V_1}$$

where V_1 is the rms amplitude of the fundamental and V_2 , V_3 , V_4 , V_5 , and V_6 are the rms amplitudes of the second to the sixth harmonics.

Peak Harmonic or Spurious Noise

Peak harmonic (spurious noise) is the ratio of the rms value of the next largest component in the ADC output spectrum (up to $f_s/2$ and excluding dc) to the rms value of the fundamental. Normally, the value of this specification is determined by the largest harmonic in the spectrum, but for ADCs where the harmonics are buried in the noise floor, it is a noise peak.

Intermodulation Distortion

With inputs consisting of sine waves at two frequencies, f_a and f_b , any active device with nonlinearities creates distortion products at the sum and difference frequencies of $m f_a \pm n f_b$ where $m, n = 0, 1, 2, 3$, and so on. Intermodulation distortion terms are those for which neither m nor n is equal to 0. For example, the second-order terms include $(f_a + f_b)$ and $(f_a - f_b)$, while the third-order terms include $(2f_a + f_b)$, $(2f_a - f_b)$, $(f_a + 2f_b)$, and $(f_a - 2f_b)$.

The AD7440/AD7450A is tested using the CCIF standard of two input frequencies near the top end of the input bandwidth. In this case, the second-order terms are distanced in frequency from the original sine waves, while the third-order terms are at a frequency close to the input frequencies. As a result, the second- and third-order terms are specified separately. The calculation of the intermodulation distortion is as per the THD specification, where it is the ratio of the rms sum of the individual distortion products to the rms amplitude of the sum of the fundamentals, expressed in dB.

Aperture Delay

This is the amount of time from the leading edge of the sampling clock until the ADC actually takes the sample.

Aperture Jitter

This is the sample-to-sample variation in the effective point in time at which the actual sample is taken.

Full Power Bandwidth

The full power bandwidth of an ADC is the input frequency at which the amplitude of the reconstructed fundamental is reduced by 0.1 dB or 3 dB for a full-scale input.

Common-Mode Rejection Ratio (CMRR)

The common-mode rejection ratio is the ratio of the power in the ADC output at full-scale frequency, f , to the power of a 100 mV p-p sine wave applied to the common-mode voltage of V_{IN+} and V_{IN-} of frequency f_s as follows:

$$\text{CMRR (dB)} = 10 \log (P_f/P_{f_s})$$

P_f is the power at the frequency f in the ADC output; P_{f_s} is the power at frequency f_s in the ADC output.

Integral Nonlinearity (INL)

This is the maximum deviation from a straight line passing through the endpoints of the ADC transfer function.

Differential Nonlinearity (DNL)

This is the difference between the measured and the ideal 1 LSB change between any two adjacent codes in the ADC.

Zero-Code Error

This is the deviation of the midscale code transition (111...111 to 000...000) from the ideal $V_{IN+} - V_{IN-}$ (i.e., 0 LSB).

Positive Gain Error

This is the deviation of the last code transition (011...110 to 011...111) from the ideal $V_{IN+} - V_{IN-}$ (i.e., $+V_{REF} - 1$ LSB), after the zero code error has been adjusted out.

Negative Gain Error

This is the deviation of the first code transition (100...000 to 100...001) from the ideal $V_{IN+} - V_{IN-}$ (i.e., $-V_{REF} + 1$ LSB), after the zero code error has been adjusted out.

Track-and-Hold Acquisition Time

The track-and-hold acquisition time is the minimum time required for the track-and-hold amplifier to remain in track mode for its output to reach and settle to within 0.5 LSB of the applied input signal.

Power Supply Rejection Ratio (PSRR)

The power supply rejection ratio is the ratio of the power in the ADC output at full-scale frequency, f , to the power of a 100 mV p-p sine wave applied to the ADC V_{DD} supply of frequency f_s . The frequency of this input varies from 1 kHz to 1 MHz.

$$PSRR \text{ (dB)} = 10\log(P_f/P_{f_s})$$

P_f is the power at frequency f in the ADC output; P_{f_s} is the power at frequency f_s in the ADC output.

AD7440/AD7450A—TYPICAL PERFORMANCE CHARACTERISTICS

$T_A = 25^\circ\text{C}$, $f_s = 1 \text{ MSPS}$, $f_{\text{SCLK}} = 18 \text{ MHz}$, unless otherwise noted.

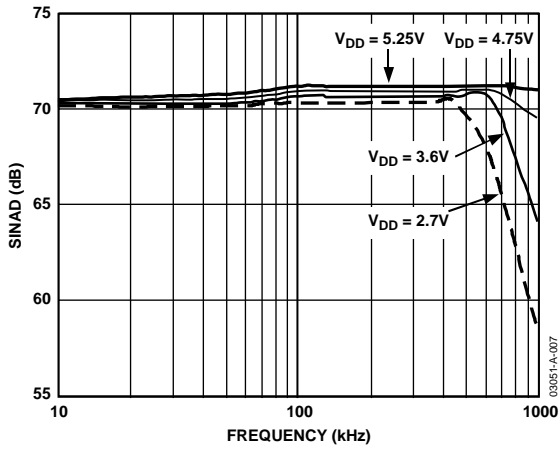

Figure 7. AD7450A SINAD vs. Analog Input Frequency for Various Supply Voltages

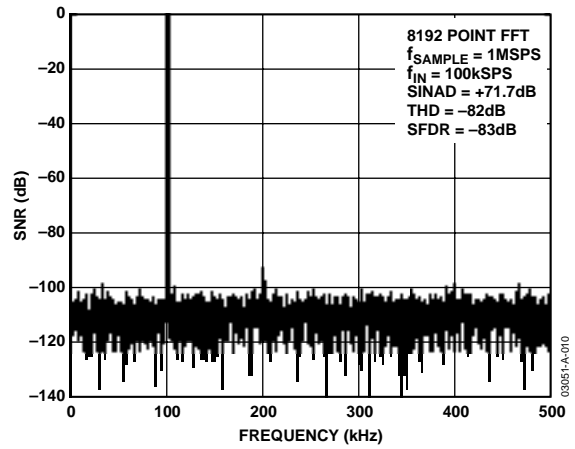

Figure 10. AD7450A Dynamic Performance with $V_{DD} = 5 \text{ V}$

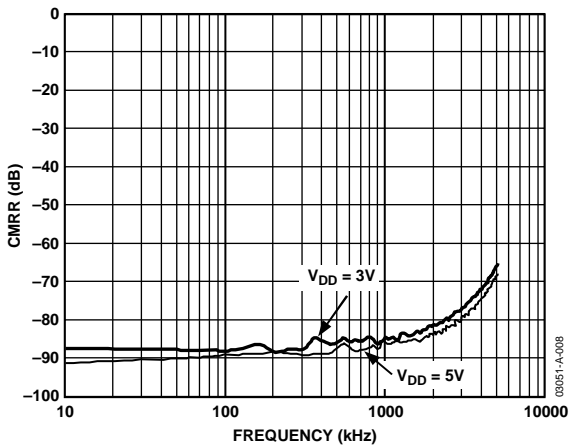

Figure 8. CMRR vs. Frequency for $V_{DD} = 5 \text{ V}$ and 3 V

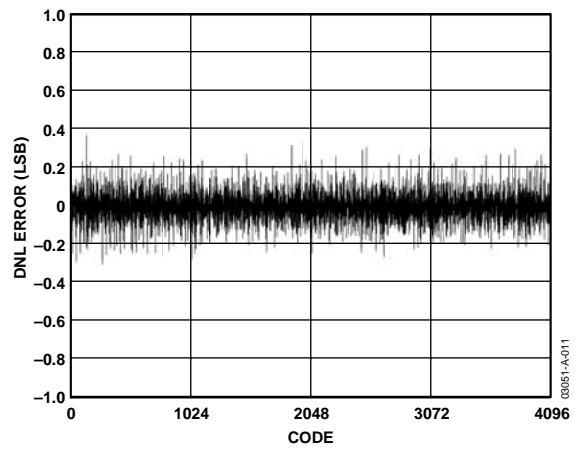

Figure 11. Typical DNL for the AD7450A for $V_{DD} = 5 \text{ V}$

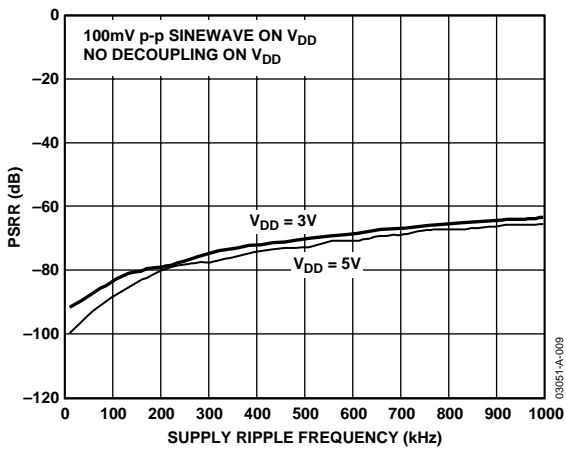

Figure 9. PSRR vs. Supply Ripple Frequency without Supply Decoupling

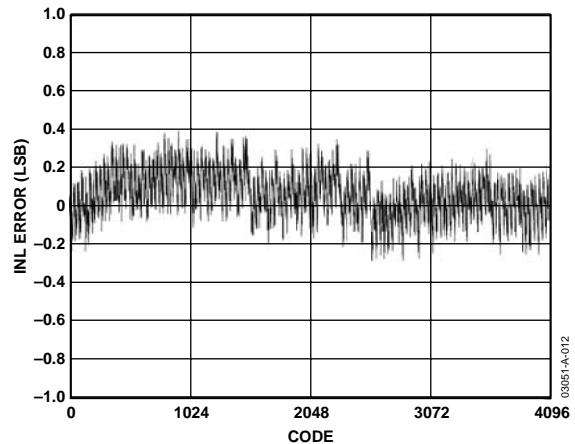

Figure 12. Typical INL for the AD7450A for $V_{DD} = 5 \text{ V}$

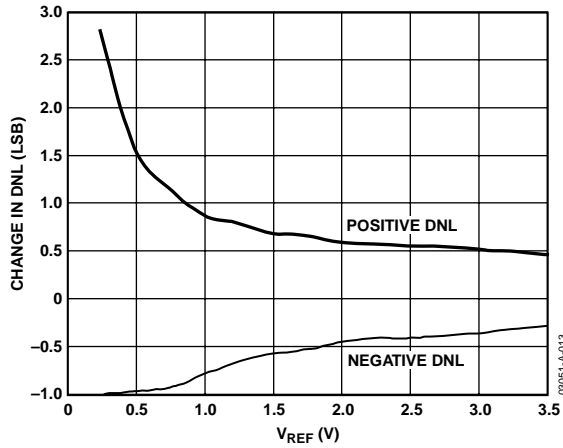

Figure 13. Change in DNL vs. V_{REF} for the AD7450A for $V_{DD} = 5V$

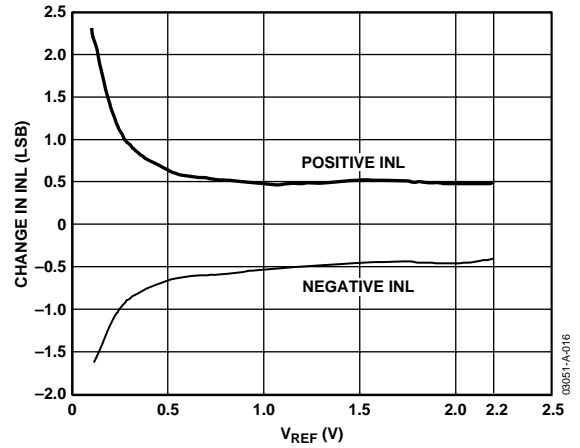

Figure 16. Change in INL vs. V_{REF} for the AD7450A for $V_{DD} = 3V$

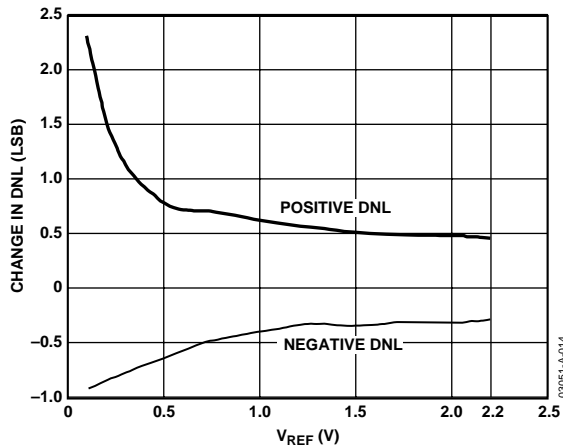

Figure 14. Change in DNL vs. V_{REF} for the AD7450A for $V_{DD} = 3V$

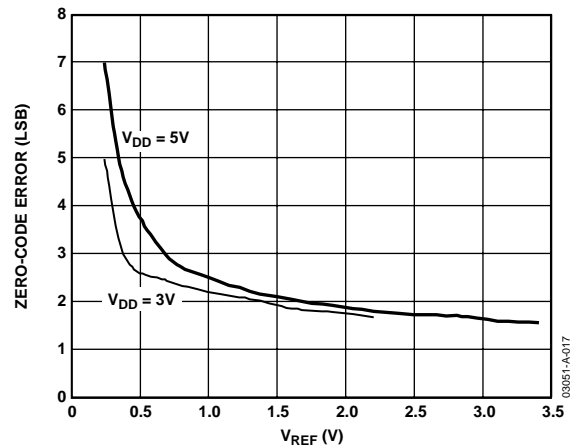

Figure 17. Change in Zero-Code Error vs. Reference Voltage for $V_{DD} = 5V$ and $3V$ for the AD7450A

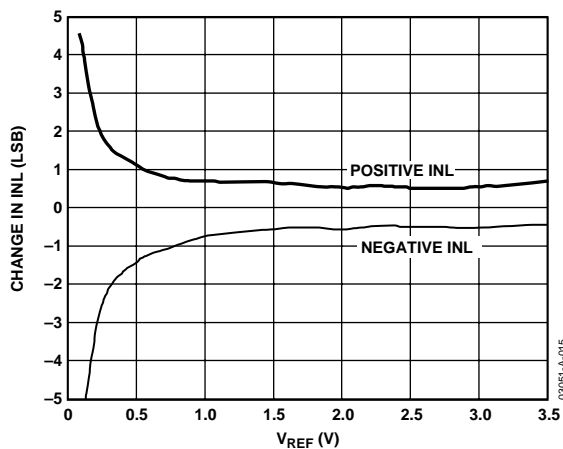

Figure 15. Change in INL vs. V_{REF} for the AD7450A for $V_{DD} = 5V$

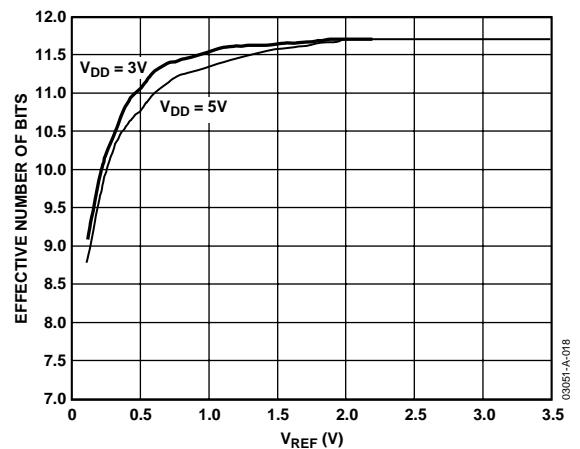

Figure 18. Change in ENOB vs. Reference Voltage for $V_{DD} = 5V$ and $3V$ for the AD7450A

AD7440/AD7450A

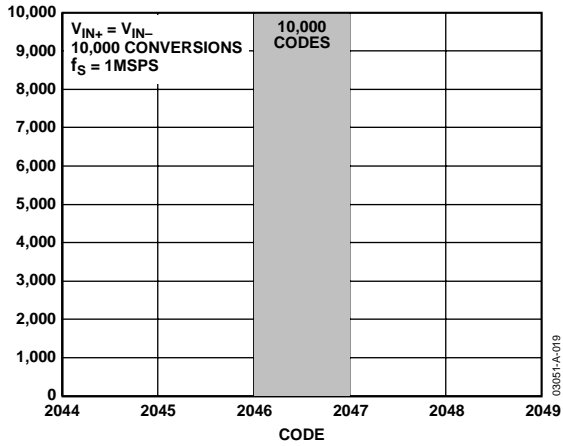

Figure 19. Histogram of 10,000 Conversions of a DC Input for the AD7450A with $V_{DD} = 5\text{ V}$

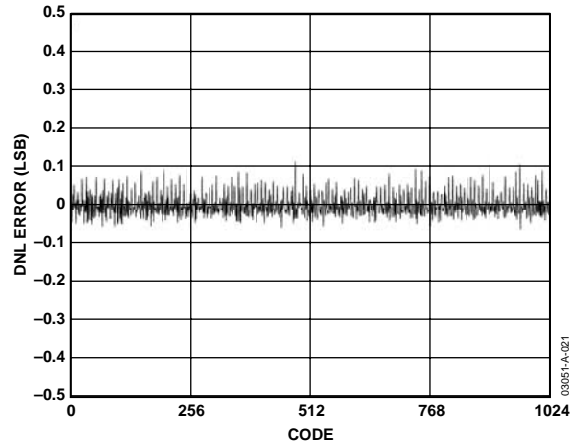

Figure 21. Typical DNL for the AD7440 for $V_{DD} = 5\text{ V}$

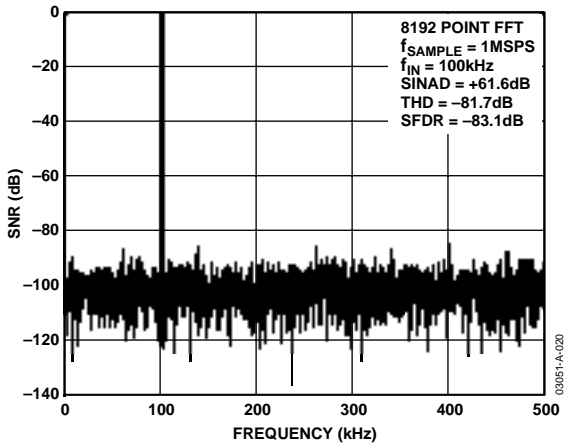

Figure 20. AD7440 Dynamic Performance with $V_{DD} = 5\text{ V}$

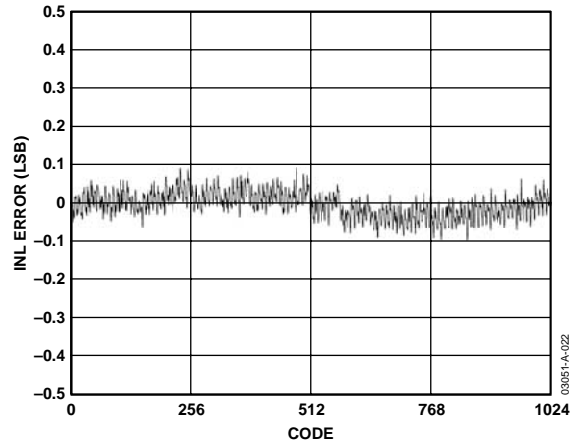

Figure 22. Typical INL for the AD7440 for $V_{DD} = 5\text{ V}$

CIRCUIT INFORMATION

The AD7440/AD7450A are 10-bit and 12-bit fast, low power, single-supply, successive approximation analog-to-digital converters (ADCs). They can operate with a 5 V or 3 V power supply and are capable of throughput rates up to 1 MSPS when supplied with an 18 MHz SCLK. They require an external reference to be applied to the V_{REF} pin, with the value of the reference chosen depending on the power supply and what suits the application.

When they are operated with a 5 V supply, the maximum reference that can be applied is 3.5 V. When they are operated with a 3 V supply, the maximum reference that can be applied is 2.2 V (see the Reference section).

The AD7440/AD7450A have an on-chip differential track-and-hold amplifier, a successive approximation (SAR) ADC, and a serial interface, housed in either an 8-lead SOT-23 or an MSOP package. The serial clock input accesses data from the part and provides the clock source for the successive approximation ADC. The AD7440/AD7450A feature a power-down option for reduced power consumption between conversions. The power-down feature is implemented across the standard serial interface as described in the Modes of Operation section.

CONVERTER OPERATION

The AD7440/AD7450A are successive approximation ADCs based around two capacitive DACs. Figure 23 and Figure 24 show simplified schematics of the ADC in acquisition and conversion phase, respectively. The ADC is comprised of control logic, an SAR, and two capacitive DACs. In Figure 23 (acquisition phase), SW3 is closed, SW1 and SW2 are in Position A, the comparator is held in a balanced condition, and the sampling capacitor arrays acquire the differential signal on the input.

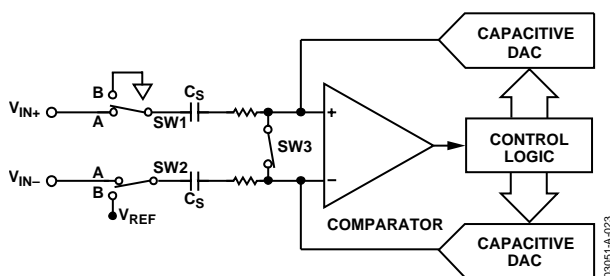

Figure 23. ADC Acquisition Phase

When the ADC starts a conversion (Figure 24), SW3 opens and SW1 and SW2 move to Position B, causing the comparator to become unbalanced. Both inputs are disconnected once the conversion begins. The control logic and the charge redistribution DACs are used to add and subtract fixed amounts of charge from the sampling capacitor arrays to bring the comparator back into a balanced condition. When the comparator is rebalanced, the conversion is complete. The control logic generates the ADC's output code. The output impedances of the sources driving the V_{IN+} and the V_{IN-} pins must be matched; otherwise, the two inputs have different settling times, resulting in errors.

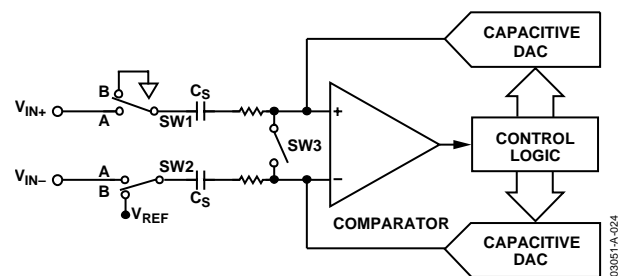

Figure 24. ADC Conversion Phase

ADC TRANSFER FUNCTION

The output coding for the AD7440/AD7450A is two's complement. The designed code transitions occur at successive LSB values (1 LSB, 2 LSBs, and so on). The LSB size of the AD7450A is $2 \times V_{REF}/4096$, and the LSB size of the AD7440 is $2 \times V_{REF}/1024$. The ideal transfer characteristic of the AD7440/AD7450A is shown in Figure 25.

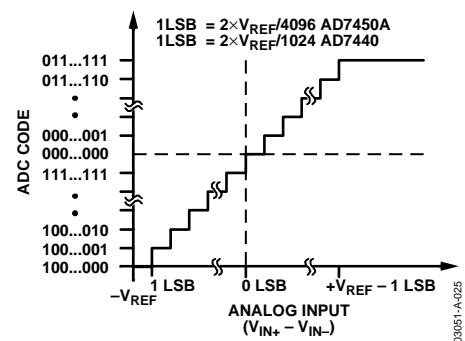

Figure 25. AD7440/AD7450A Ideal Transfer Characteristic

AD7440/AD7450A

TYPICAL CONNECTION DIAGRAM

Figure 26 shows a typical connection diagram for the AD7440/AD7450A for both 5 V and 3 V supplies. In this setup, the GND pin is connected to the analog ground plane of the system. The V_{REF} pin is connected to either a 2.5 V or a 2 V decoupled reference source, depending on the power supply, to set up the analog input range. The common-mode voltage has to be set up externally and is the value on which the two inputs are centered. The conversion result is output in a 16-bit word with 4 leading zeros followed by the MSB of the 12-bit or 10-bit result. The 10-bit result of the AD7440 is followed by 2 trailing zeros. For more details on driving the differential inputs and setting up the common mode, refer to the Driving Differential Inputs section.

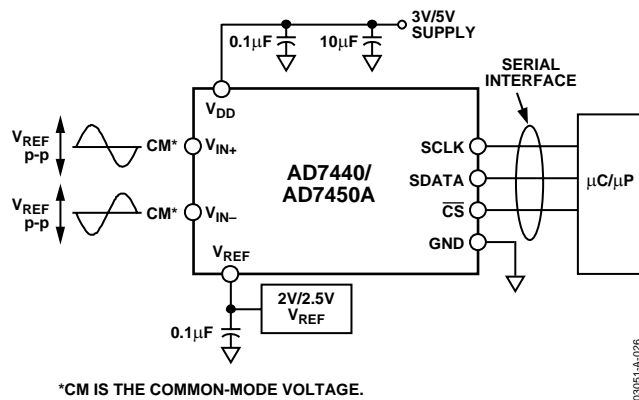

Figure 26. Typical Connection Diagram

ANALOG INPUT

The analog input of the AD7440/AD7450A is fully differential. Differential signals have a number of benefits over single-ended signals, including noise immunity based on the device's common-mode rejection, improvements in distortion performance, doubling of the device's available dynamic range, and flexibility in input ranges and bias points. Figure 27 defines the fully differential analog input of the AD7440/AD7450A.

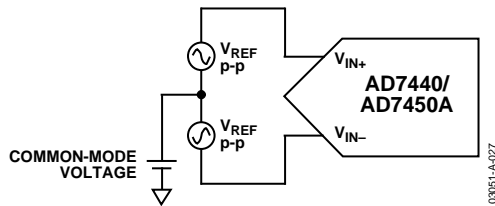

Figure 27. Differential Input Definitions

The amplitude of the differential signal is the difference between the signals applied to the V_{IN+} and V_{IN-} pins (i.e., $V_{IN+} - V_{IN-}$). V_{IN+} and V_{IN-} are simultaneously driven by two signals each of amplitude V_{REF} that are 180° out of phase. The amplitude of the differential signal is therefore $-V_{REF}$ to $+V_{REF}$ peak-to-peak ($2 \times V_{REF}$). This is true regardless of the common mode (CM).

The common mode is the average of the two signals, that is, $(V_{IN+} + V_{IN-})/2$ and is therefore the voltage that the two inputs are centered on. This results in the span of each input being $CM \pm V_{REF}/2$. This voltage has to be set up externally, and its range varies with V_{REF} . As the value of V_{REF} increases, the common-mode range decreases. When driving the inputs with an amplifier, the actual common-mode range is determined by the amplifier's output voltage swing.

Figure 28 and Figure 29 show how the common-mode range typically varies with V_{REF} for both a 5 V and a 3 V power supply. The common mode must be in this range to guarantee the functionality of the AD7440/AD7450A.

For ease of use, the common mode can be set up to equal V_{REF} , resulting in the differential signal being $\pm V_{REF}$ centered on V_{REF} .

When a conversion takes place, the common mode is rejected, resulting in a virtually noise-free signal of amplitude $-V_{REF}$ to $+V_{REF}$, corresponding to the digital codes of 0 to 4096 in the case of the AD7450A and 0 to 1024 in the AD7440.

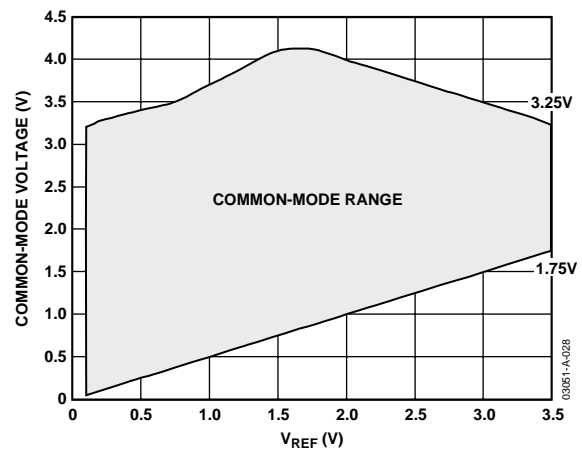

Figure 28. Input Common-Mode Range vs. V_{REF}
($V_{DD} = 5\text{ V}$ and $V_{REF}(\text{Max}) = 3.5\text{ V}$)

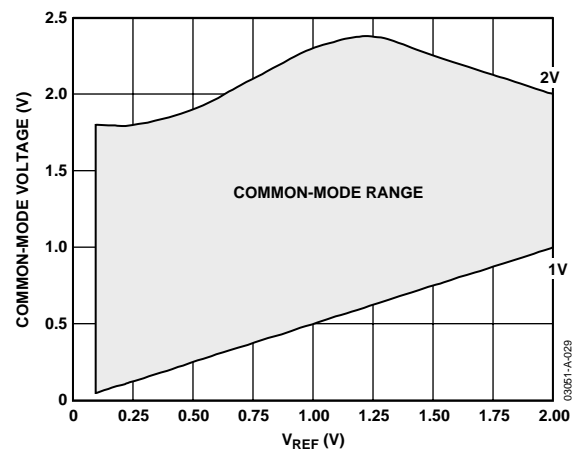

Figure 29. Input Common-Mode Range vs. V_{REF}
($V_{DD} = 3\text{ V}$ and $V_{REF}(\text{Max}) = 2\text{ V}$)

Figure 30 shows examples of the inputs to V_{IN+} and V_{IN-} for different values of V_{REF} for $V_{DD} = 5\text{ V}$. It also gives the maximum and minimum common-mode voltages for each reference value according to Figure 28.

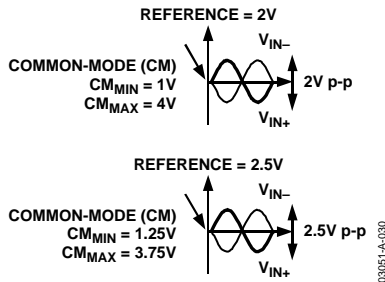

Figure 30. Examples of the Analog Inputs to V_{IN+} and V_{IN-} for Different Values of V_{REF} for $V_{DD} = 5\text{ V}$

Analog Input Structure

Figure 31 shows the equivalent circuit of the analog input structure of the AD7440/AD7450A. The four diodes provide ESD protection for the analog inputs. Care must be taken to ensure that the analog input signals never exceed the supply rails by more than 300 mV. This causes these diodes to become forward biased and start conducting into the substrate. These diodes can conduct up to 10 mA without causing irreversible damage to the part. The capacitors, C1 in Figure 31, are typically 4 pF and can primarily be attributed to pin capacitance. The resistors are lumped components made up of the on resistance of the switches. The value of these resistors is typically about 100 Ω . The capacitors, C2, are the ADC's sampling capacitors and have a capacitance of 16 pF typically.

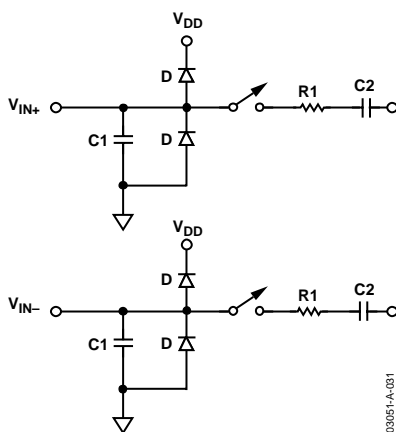

Figure 31. Equivalent Analog Input Circuit Conversion Phase—Switches Open; Track Phase—Switches Closed

For ac applications, removing high frequency components from the analog input signal through the use of an RC low-pass filter on the relevant analog input pins is recommended. In applications where harmonic distortion and signal-to-noise ratio are critical, the analog input should be driven from a low impedance source. Large source impedances significantly affect the ac performance of the ADC. This may necessitate the use of an input buffer amplifier. The choice of op amp is a function of the particular application.

When no amplifier is used to drive the analog input, the source impedance should be limited to low values. The maximum source impedance depends on the amount of total harmonic distortion (THD) that can be tolerated. The THD increases as the source impedance increases, and performance degrades. Figure 32 shows a graph of THD versus the analog input signal frequency for different source impedances for $V_{DD} = 5\text{ V}$.

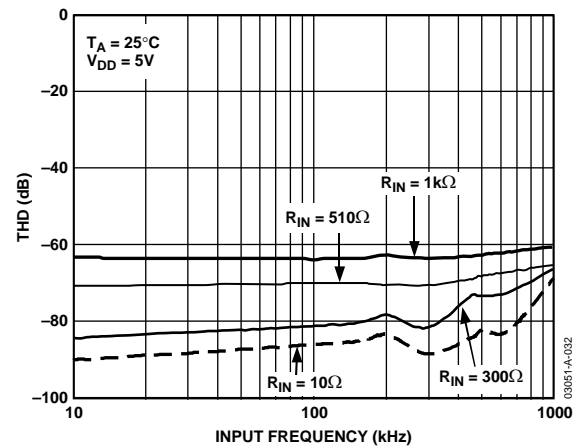

Figure 32. THD vs. Analog Input Frequency for Various Source Impedances for $V_{DD}=5\text{V}$

Figure 33 shows a graph of the THD versus the analog input frequency for V_{DD} of $5\text{ V} \pm 5\%$ and $3\text{ V} + 20\%/-10\%$, while sampling at 1 MSPS with an SCLK of 18 MHz. In this case, the source impedance is 10 Ω .

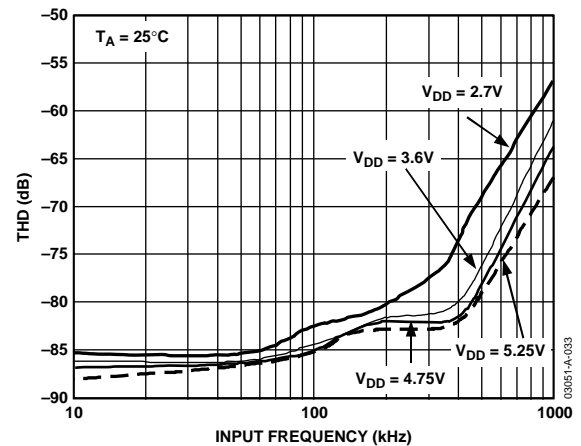

Figure 33. THD vs. Analog Input Frequency for 3 V and 5 V Supply Voltages

DRIVING DIFFERENTIAL INPUTS

Differential operation requires V_{IN+} and V_{IN-} to be driven simultaneously with two equal signals that are 180° out of phase. The common mode must be set up externally and has a range determined by V_{REF} , the power supply, and the particular amplifier used to drive the analog inputs (see Figure 28 and Figure 29). Differential modes of operation with either an ac or dc input provide the best THD performance over a wide frequency range. Because not all applications have a signal preconditioned for differential operation, there is often a need to perform single-ended-to-differential conversion.

Differential Amplifier

An ideal method of applying differential drive to the AD7440/AD7450A is to use a differential amplifier such as the AD8138. This part can be used as a single-ended-to-differential amplifier or as a differential-to-differential amplifier. In both cases, the analog input needs to be bipolar. It also provides common-mode level shifting and buffering of the bipolar input signal. Figure 34 shows how the AD8138 can be used as a single-ended-to-differential amplifier. The positive and negative outputs of the AD8138 are connected to the respective inputs on the ADC via a pair of series resistors to minimize the effects

of switched capacitance on the front end of the ADCs. The RC low-pass filter on each analog input is recommended in ac applications to remove high frequency components of the analog input. The architecture of the AD8138 results in outputs that are very highly balanced over a wide frequency range without requiring tightly matched external components.

If the analog input source being used has zero impedance, all four resistors (R_{G1} , R_{G2} , R_{F1} , and R_{F2}) should be the same. If the source has a $50\ \Omega$ impedance and a $50\ \Omega$ termination, for example, the value of R_{G2} should be increased by $25\ \Omega$ to balance this parallel impedance on the input and thus ensure that both the positive and negative analog inputs have the same gain (see Figure 34). The outputs of the amplifier are perfectly matched, balanced differential outputs of identical amplitude and are exactly 180° out of phase.

The AD8138 is specified with $+3\ \text{V}$, $+5\ \text{V}$, and $\pm 5\ \text{V}$ power supplies, but the best results are obtained with a $\pm 5\ \text{V}$ supply. The AD8132 is a lower cost device that could also be used in this configuration with slight differences in characteristics to the AD8138 but with similar performance and operation.

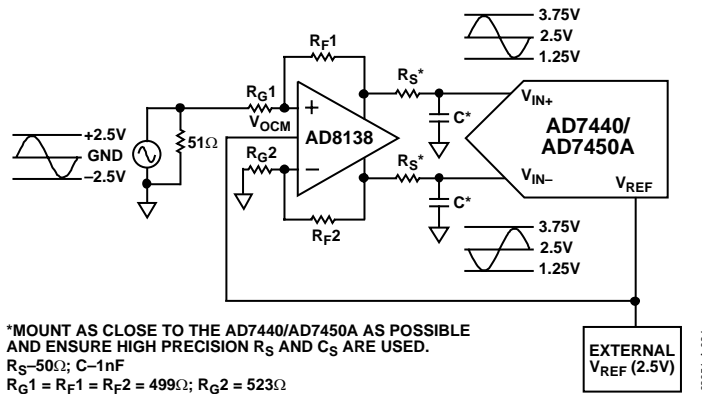

Figure 34. Using the AD8138 as a Single-Ended-to-Differential Amplifier

Op Amp Pair

An op amp pair can be used to directly couple a differential signal to the AD7440/AD7450A. The circuit configurations shown in Figure 35 and Figure 36 show how a dual op amp can be used to convert a single-ended signal into a differential signal for both a bipolar and unipolar input signal, respectively.

The voltage applied to Point A sets up the common-mode voltage. In both diagrams, it is connected in some way to the reference, but any value in the common-mode range can be input here to set up the common mode. The AD8022 is a suitable dual op amp that could be used in this configuration to provide differential drive to the AD7440/AD7450A.

Take care when choosing the op amp; the selection depends on the required power supply and system performance objectives. The driver circuits in Figure 35 and Figure 36 are optimized for dc coupling applications requiring best distortion performance.

The circuit configuration shown in Figure 35 converts a unipolar, single-ended signal into a differential signal.

The differential op amp driver circuit in Figure 36 is configured to convert and level shift a single-ended, ground-referenced (bipolar) signal to a differential signal centered at the V_{REF} level of the ADC.

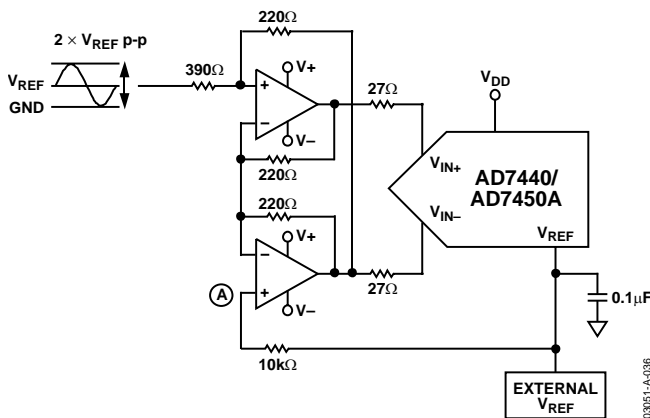

Figure 35. Dual Op Amp Circuit to Convert a Single-Ended Unipolar Signal into a Differential Signal

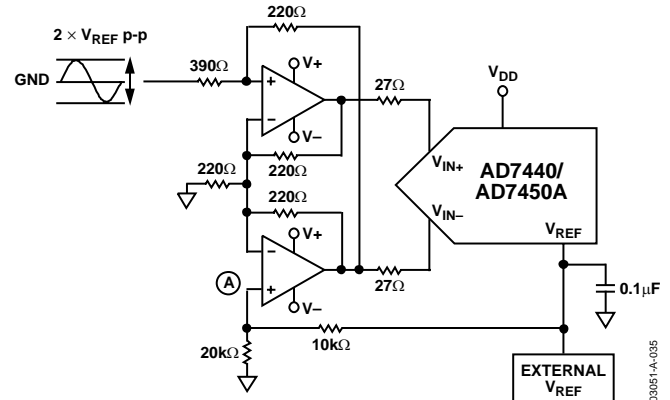

Figure 36. Dual Op Amp Circuit to Convert a Single-Ended Bipolar Signal into a Differential Signal

RF Transformer

An RF transformer with a center tap offers a good solution for generating differential inputs in systems that do not need to be dc-coupled. Figure 37 shows how a transformer is used for single-ended-to-differential conversion. It provides the benefits of operating the ADC in the differential mode without contributing additional noise and distortion. An RF transformer also has the benefit of providing electrical isolation between the signal source and the ADC. A transformer can be used for most ac applications. The center tap is used to shift the differential signal to the common-mode level required; in this case, it is connected to the reference so the common-mode level is the value of the reference.

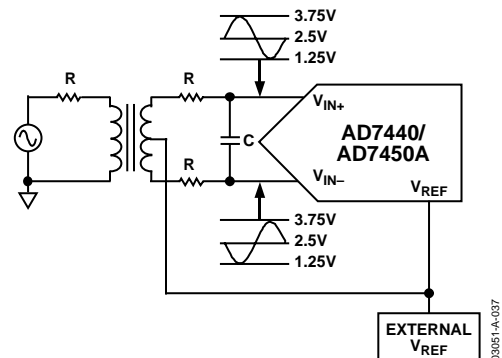

Figure 37. Using an RF Transformer to Generate Differential Inputs

AD7440/AD7450A

DIGITAL INPUTS

The digital inputs applied to the device are not limited by the maximum ratings, which limit the analog limits. Instead the digital inputs applied, \overline{CS} and SCLK, can go to 7 V and are not restricted by the $V_{DD} + 0.3$ V limits as on the analog input.

The main advantage of the inputs not being restricted to the $V_{DD} + 0.3$ V limit is that power supply sequencing issues are avoided. If \overline{CS} and SCLK are applied before V_{DD} , there is no risk of latch-up as there would be on the analog inputs if a signal greater than 0.3 V was applied prior to V_{DD} .

REFERENCE

An external reference source is required to supply the reference to the device. This reference input can range from 100 mV to 3.5 V. With a 5 V power supply, the specified reference is 2.5 V and the maximum reference is 3.5 V. With a 3 V power supply, the specified reference is 2 V and the maximum reference is 2.2 V. In both cases, the reference is functional from 100 mV.

Ensure that, when choosing the reference value for a particular application, the maximum analog input range ($V_{IN\ max}$) is never greater than $V_{DD} + 0.3$ V to comply with the maximum ratings of the device. The following two examples calculate the maximum V_{REF} input that can be used when operating the AD7440/AD7450A at a V_{DD} of 5 V and 3 V, respectively.

Example 1

$$V_{IN\ max} = V_{DD} + 0.3$$

$$V_{IN\ max} = V_{REF} + V_{REF}/2$$

If $V_{DD} = 5$ V, then $V_{IN\ max} = 5.3$ V.

Therefore

$$3 \times V_{REF}/2 = 5.3$$

$$V_{REF\ max} = 3.5$$

Thus, when operating at $V_{DD} = 5$ V, the value of V_{REF} can range from 100 mV to a maximum value of 3.5 V. When $V_{DD} = 4.75$ V, $V_{REF\ max} = 3.17$ V.

Example 2

$$V_{IN\ max} = V_{DD} + 0.3$$

$$V_{IN\ max} = V_{REF} + V_{REF}/2$$

If $V_{DD} = 3$ V, then $V_{IN\ max} = 3.3$ V.

Therefore,

$$3 \times V_{REF}/2 = 3.3$$

$$V_{REF\ max} = 2.2$$

Thus, when operating at $V_{DD} = 3$ V, the value of V_{REF} can range from 100 mV to a maximum value of 2.2 V. When $V_{DD} = 2.7$ V, $V_{REF\ max} = 2$ V.

These examples show that the maximum reference applied to the AD7440/AD7450A is directly dependent on the value applied to V_{DD} .

The value of the reference sets the analog input span and the common-mode voltage range. Errors in the reference source result in gain errors in the AD7440/AD7450A transfer function and add to specified full-scale errors on the part. A 0.1 μ F capacitor should be used to decouple the V_{REF} pin to GND.

Figure 38 shows a typical connection diagram for the V_{REF} pin. Table 6 lists examples of suitable voltage references.

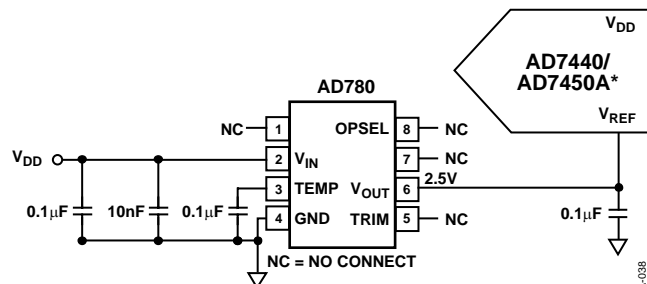

*ADDITIONAL PINS OMITTED FOR CLARITY

Figure 38. Typical V_{REF} Connection Diagram for $V_{DD} = 5$ V

Table 6. Examples of Suitable Voltage References

Reference	Output Voltage (V)	Initial Accuracy (%)	Operating Current (μ A)
AD780	2.5/3	0.04	1000
ADR421	2.5	0.04	500
ADR420	2.048	0.05	500

SINGLE-ENDED OPERATION

When supplied with a 5 V power supply, the AD7440/AD7450A can handle a single-ended input. The design of these devices is optimized for differential operation, so with a single-ended input, performance degrades. Linearity degrades by typically 0.2 LSB, the full-scale errors degrade typically by 1 LSB, and ac performance is not guaranteed.

To operate the AD7440/AD7450A in single-ended mode, the V_{IN+} input is coupled to the signal source, while the V_{IN-} input is biased to the appropriate voltage corresponding to the midscale code transition. This voltage is the common mode, which is a fixed dc voltage (usually the reference). The V_{IN+} input swings around this value and should have a voltage span of $2 \times V_{REF}$ to make use of the full dynamic range of the part. The input signal therefore has peak-to-peak values of common mode $\pm V_{REF}$. If the analog input is unipolar, an op amp in a noninverting unity gain configuration can be used to drive the V_{IN+} pin. The ADC operates from a single supply, so it is necessary to level shift ground-based bipolar signals to comply with the input requirements. An op amp can be configured to rescale and level shift the ground-based bipolar signal, so it is compatible with the selected input range of the AD7440/AD7450A (Figure 39).

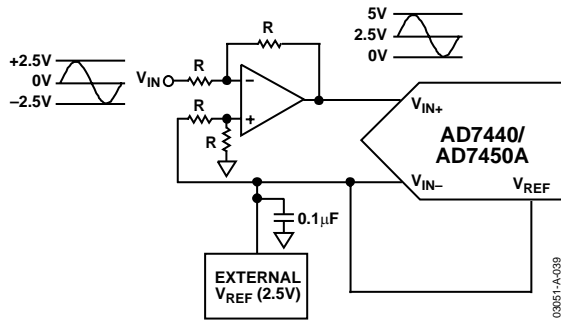

Figure 39. Applying a Bipolar Single-Ended Input to the AD7440/AD7450A

SERIAL INTERFACE

Figure 2 and Figure 3 show detailed timing diagrams for the serial interface of the AD7450A and the AD7440, respectively. The serial clock provides the conversion clock and also controls the transfer of data from the devices during conversion. \overline{CS} initiates the conversion process and frames the data transfer.

The falling edge of \overline{CS} puts the track-and-hold into hold mode and takes the bus out of three-state. The analog input is sampled and the conversion is initiated at this point. The conversion requires 16 SCLK cycles to complete.

Once 13 SCLK falling edges have occurred, the track-and-hold goes back into track on the next SCLK rising edge, as shown at Point B in Figure 2 and Figure 3. On the 16th SCLK falling edge, the SDATA line goes back into three-state. If the rising edge of \overline{CS} occurs before 16 SCLKs have elapsed, the conversion terminates and the SDATA line goes back into three-state.

The conversion result from the AD7440/AD7450A is provided on the SDATA output as a serial data stream. The bits are clocked out on the falling edge of the SCLK input. The data stream of the AD7450A consists of four leading zeros followed by 12 bits of conversion data provided MSB first; the data stream of the AD7440 consists of four leading zeros, followed by the 10 bits of conversion data followed by two trailing zeros, which is also provided MSB first. In both cases, the output coding is twos complement.

Sixteen serial clock cycles are required to perform a conversion and access data from the AD7440/AD7450A. \overline{CS} going low provides the first leading zero to be read in by the DSP or microcontroller. The remaining data is then clocked out on the subsequent SCLK falling edges beginning with the second leading zero. Thus, the first falling clock edge on the serial clock provides the second leading zero. The final bit in the data transfer is valid on the 16th falling edge, having been clocked out on the previous (15th) falling edge. Once the conversion is complete and the data has been accessed after the 16 clock cycles, it is important to ensure that before the next conversion is initiated, enough time is left to meet the acquisition and quiet time specifications (see Timing Examples 1 and 2). To achieve 1 MSPS with an 18 MHz clock for $V_{DD} = 3\text{ V}$ and 5 V , an 18-clock burst performs the conversion and leaves enough time before the next conversion for the acquisition and quiet time.

In applications with a slower SCLK, it may be possible to read in data on each SCLK rising edge; that is, the first rising edge of SCLK after the \overline{CS} falling edge would have the leading zero provided and the 15th SCLK edge would have DB0 provided.

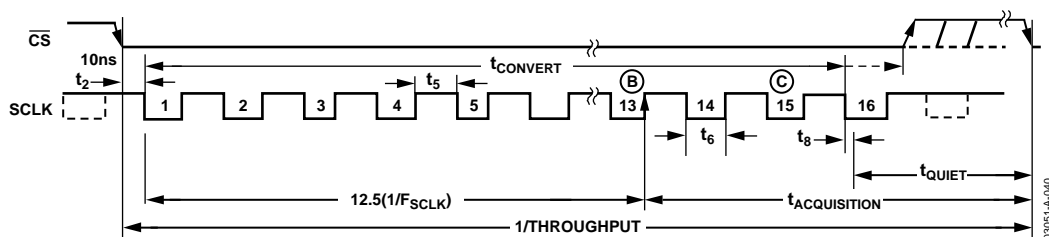

Figure 40. Serial Interface Timing Example

Timing Example 1

Having $F_{SCLK} = 18$ MHz and a throughput rate of 1 MSPS gives a cycle time of

$$1/Throughput = 1/1,000,000 = 1 \mu s$$

A cycle consists of

$$t_2 + 12.5(1/F_{SCLK}) + t_{ACQ} = 1 \mu s$$

Therefore, if $t_2 = 10$ ns

$$\begin{aligned} 10 \text{ ns} + 12.5(1/18 \text{ MHz}) + t_{ACQ} &= 1 \mu s \\ t_{ACQ} &= 296 \text{ ns} \end{aligned}$$

This 296 ns satisfies the requirement of 290 ns for t_{ACQ} .

From Figure 40, t_{ACQ} comprises

$$2.5(1/F_{SCLK}) + t_8 + t_{QUIET}$$

where $t_8 = 35$ ns. This allows a value of 122 ns for t_{QUIET} , satisfying the minimum requirement of 60 ns.

Timing Example 2

Having $F_{SCLK} = 5$ MHz and a throughput rate of 315 kSPS gives a cycle time of

$$1/Throughput = 1/315,000 = 3.174 \mu s$$

A cycle consists of

$$t_2 + 12.5(1/F_{SCLK}) + t_{ACQ} = 3.174 \mu s$$

Therefore, if t_2 is 10 ns

$$\begin{aligned} 10 \text{ ns} + 12.5(1/5 \text{ MHz}) + t_{ACQ} &= 3.174 \mu s \\ t_{ACQ} &= 664 \text{ ns} \end{aligned}$$

This 664 ns satisfies the requirement of 290 ns for t_{ACQ} .

From Figure 40, t_{ACQ} comprises

$$2.5(1/F_{SCLK}) + t_8 + t_{QUIET}$$

where $t_8 = 35$ ns. This allows a value of 129 ns for t_{QUIET} , satisfying the minimum requirement of 60 ns.

As in this example and with other slower clock values, the signal may already be acquired before the conversion is complete, but it is still necessary to leave 60 ns minimum t_{QUIET} between conversions. In Timing Example 2, the signal should be fully acquired at approximately Point C in Figure 40.

MODES OF OPERATION

The operational mode of the AD7440/AD7450A is selected by controlling the logic state of the $\overline{\text{CS}}$ signal during a conversion. There are two possible modes of operation, normal and power down. The point at which $\overline{\text{CS}}$ is pulled high after the conversion has been initiated determines whether or not the device enters power-down mode. Similarly, if already in power-down, $\overline{\text{CS}}$ controls whether the devices return to normal operation or remain in power-down. These modes of operation are designed to provide flexible power management options. These options can be chosen to optimize the power dissipation/throughput rate ratio for differing application requirements.

NORMAL MODE

This mode is intended for fastest throughput rate performance. The user does not have to worry about any power-up times with the AD7440/AD7450A remaining fully powered up all the time. Figure 41 shows the general diagram of the operation of the AD7440/AD7450A in this mode. The conversion is initiated on the falling edge of $\overline{\text{CS}}$, as described in the Serial Interface section. To ensure the part remains fully powered up, $\overline{\text{CS}}$ must remain low until at least 10 SCLK falling edges have elapsed after the falling edge of $\overline{\text{CS}}$.

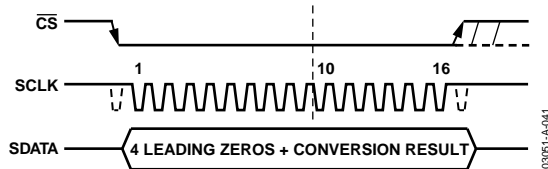

Figure 41. Normal Mode Operation

If $\overline{\text{CS}}$ is brought high any time after the 10th SCLK falling edge, but before the 16th SCLK falling edge, the part remains powered up but the conversion terminates and SDATA goes back into three-state. Sixteen serial clock cycles are required to complete the conversion and access the complete conversion result. $\overline{\text{CS}}$ may idle high until the next conversion or may idle low until sometime prior to the next conversion. Once a data transfer is complete, when SDATA has returned to three-state, another conversion can be initiated after the quiet time, t_{QUIET} , has elapsed by again bringing $\overline{\text{CS}}$ low.

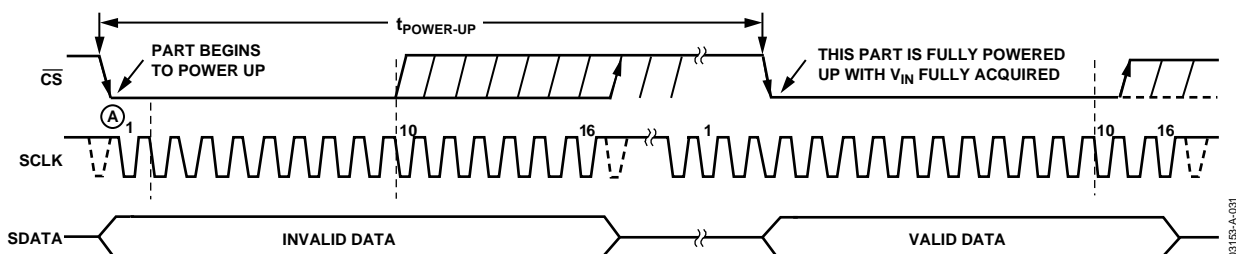

Figure 43. Exiting Power-Down Mode

POWER-DOWN MODE

This mode is intended for use in applications where slower throughput rates are required; either the ADC is powered down between each conversion, or a series of conversions may be performed at a high throughput rate and the ADC is then powered down for a relatively long duration between these bursts of conversions. When the AD7440/AD7450A are in the power-down mode, all analog circuitry is powered down. To enter power-down mode, the conversion process must be interrupted by bringing $\overline{\text{CS}}$ high anywhere after the second falling edge of SCLK and before the 10th falling edge of SCLK, as shown in Figure 42.

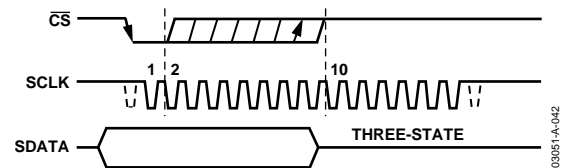

Figure 42. Entering Power-Down Mode

Once $\overline{\text{CS}}$ has been brought high in this window of SCLKs, the part enters power-down, the conversion that was initiated by the falling edge of $\overline{\text{CS}}$ is terminated, and SDATA goes back into three-state. The time from the rising edge of $\overline{\text{CS}}$ to SDATA three-state enabled is never greater than t_s (refer to the Timing Specifications). If $\overline{\text{CS}}$ is brought high before the second SCLK falling edge, the part remains in normal mode and does not power down. This avoids accidental power-down due to glitches on the $\overline{\text{CS}}$ line.

In order to exit this mode of operation and power up the AD7440/AD7450A again, a dummy conversion is performed. On the falling edge of $\overline{\text{CS}}$, the device begins to power up and continues to power up as long as $\overline{\text{CS}}$ is held low until after the falling edge of the 10th SCLK. The device is fully powered up after 1 μs has elapsed and, as shown in Figure 43, valid data results from the next conversion.

AD7440/AD7450A

If \overline{CS} is brought high before the 10th falling edge of SCLK, the AD7440/AD7450A again goes back into power-down. This avoids accidental power-up due to glitches on the \overline{CS} line or an inadvertent burst of eight SCLK cycles while \overline{CS} is low. So although the device may begin to power up on the falling edge of \overline{CS} , it again powers down on the rising edge of \overline{CS} as long as it occurs before the 10th SCLK falling edge.

POWER-UP TIME

The power-up time of the AD7440/AD7450A is typically 1 μ s, which means that with any frequency of SCLK up to 18 MHz, one dummy cycle is always sufficient to allow the device to power up. Once the dummy cycle is complete, the ADC is fully powered up and the input signal is acquired properly. The quiet time, t_{QUIET} , must still be allowed from the point at which the bus goes back into three-state after the dummy conversion to the next falling edge of \overline{CS} .

When running at the maximum throughput rate of 1 MSPS, the AD7440/AD7450A power up and acquire a signal within ± 0.5 LSB in one dummy cycle, 1 μ s. When powering up from the power-down mode with a dummy cycle, as in Figure 43, the track-and-hold, which was in hold mode while the part was powered down, returns to track mode after the first SCLK edge the part receives after the falling edge of \overline{CS} . This is shown as Point A in Figure 43.

Although at any SCLK frequency one dummy cycle is sufficient to power up the device and acquire V_{IN} , it does not mean that a full dummy cycle of 16 SCLKs must always elapse to power up the device and acquire V_{IN} fully; 1 μ s is sufficient to power up the device and acquire the input signal.

For example, if a 5 MHz SCLK frequency was applied to the ADC, the cycle time would be 3.2 μ s ($1/(5 \text{ MHz}) \times 16$). In one dummy cycle, 3.2 μ s, the part would be powered up and V_{IN} acquired fully. However, after 1 μ s with a 5 MHz SCLK, only five SCLK cycles would have elapsed. At this stage, the ADC would be fully powered up and the signal acquired. So in this case, the \overline{CS} can be brought high after the 10th SCLK falling edge and brought low again after a time, t_{QUIET} , to initiate the conversion.

When power supplies are first applied to the device, the ADC may power up in either power-down mode or normal mode. Because of this, it is best to allow a dummy cycle to elapse to ensure the part is fully powered up before attempting a valid conversion. Likewise, if the user wants the part to power up in power-down mode, the dummy cycle may be used to ensure the device is in power-down by executing a cycle such as the one shown in Figure 42.

Once supplies are applied to the AD7440/AD7450A, the power-up time is the same as that when powering up from power-down mode. It takes about 1 μ s to power up fully if the part powers up in normal mode. It is not necessary to wait 1 μ s before executing a dummy cycle to ensure the desired mode of operation. Instead, the dummy cycle can occur directly after power is supplied to the ADC. If the first valid conversion is then performed directly after the dummy conversion, ensure that adequate acquisition time has been allowed.

As mentioned earlier, when powering up from the power-down mode, the part returns to track mode upon the first SCLK edge applied after the falling edge of \overline{CS} . However, when the ADC powers up initially after supplies are applied, the track-and-hold is already in track mode. Assuming the user has the facility to monitor the ADC supply current, this means the ADC powers up in the desired mode of operation, and thus a dummy cycle is not required to change mode. A dummy cycle is therefore not required to place the track-and-hold into track mode.

POWER VS. THROUGHPUT RATE

By using the power-down mode on the AD7440/AD7450A when not converting, the average power consumption of the ADC decreases at lower throughput rates. Figure 44 shows how, as the throughput rate is reduced, the device remains in its power-down state longer and the average power consumption is reduced accordingly for both 5 V and 3 V power supplies.

For example, if the AD7440/AD7450A are operated in continuous sampling mode with a throughput rate of 100 kSPS and an SCLK of 18 MHz, and the device is placed in power-down mode between conversions, the power consumption is calculated as follows:

Power Dissipation during Normal Operation = 9.25 mW max
(for $V_{\text{DD}} = 5 \text{ V}$)

If the power-up time is one dummy cycle (1 μ s), and the remaining conversion time is another cycle (1 μ s), the AD7440/AD7450A can be said to dissipate 9.25 mW for 2 μ s¹ during each conversion cycle.

If the throughput rate = 100 kSPS, the cycle time = 10 μ s and the average power dissipated during each cycle is $(2/10) \times 9.25 \text{ mW} = 1.85 \text{ mW}$.

For the same scenario, if $V_{\text{DD}} = 3 \text{ V}$, the power dissipation during normal operation is 4 mW max.

The AD7440/AD7450A can now be said to dissipate 4 mW for 2 μ s¹ during each conversion cycle.

¹This figure assumes a very short time to enter power-down mode. This increases as the burst of clocks used to enter this mode is increased.

Thus, the average power dissipated during each cycle with a throughput rate of 100 kSPS is $(2/10) \times 4 \text{ mW} = 0.8 \text{ mW}$.

This is how the power numbers in Figure 44 are calculated.

For throughput rates above 320 kSPS, it is recommended to reduce the serial clock frequency for best power performance.

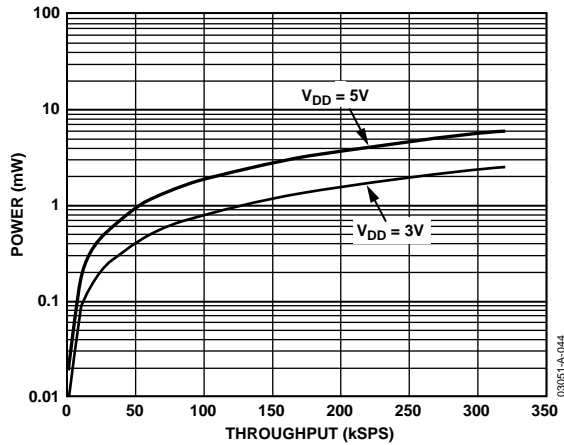

Figure 44. Power vs. Throughput Rate for Power-Down Mode

MICROPROCESSOR AND DSP INTERFACING

The serial interface on the AD7440/AD7450A allows the parts to be directly connected to many different microprocessors. This section explains how to interface the AD7440/AD7450A with some of the more common microcontroller and DSP serial interface protocols.

AD7440/AD7450A to ADSP-21xx

The ADSP-21xx family of DSPs is interfaced directly to the AD7440/AD7450A without any glue logic required.

The SPORT control register should be set up as follows:

TFSW = RFSW = 1	Alternate framing
INVRFS = INVTFS = 1	Active low frame signal
DTYPE = 00	Right-justify data
SLEN = 1111	16-bit data-words
ISCLK = 1	Internal serial clock
TFSR = RFSR = 1	Frame every word
IRFS = 0	
ITFS = 1	

To implement power-down mode, SLEN should be set to 1001 to issue an 8-bit SCLK burst.

The connection diagram is shown in Figure 45. The ADSP-21xx has the TFS and RFS of the SPORT tied together, with TFS set as an output and RFS set as an input. The DSP operates in alternate framing mode and the SPORT control register is set up as described. The frame synchronization signal generated on the TFS is tied to $\overline{\text{CS}}$ and, as with all signal processing applications, equidistant sampling is necessary. However in this example, the timer interrupt is used to control the sampling rate of the ADC; under certain conditions, equidistant sampling may not be achieved.

The timer registers, for example, are loaded with a value that provides an interrupt at the required sample interval. When an interrupt is received, a value is transmitted with TFS/DT (ADC control word). The TFS is used to control the RFS and therefore the reading of data. The frequency of the serial clock is set in the SCLKDIV register. When the instruction to transmit with TFS is given ($\text{AX0} = \text{TX0}$), the state of the SCLK is checked. The DSP waits until the SCLK has gone high, low, and high again before starting transmission. If the timer and SCLK values are chosen such that the instruction to transmit occurs on or near the rising edge of SCLK, then the data may be transmitted or it may wait until the next clock edge.

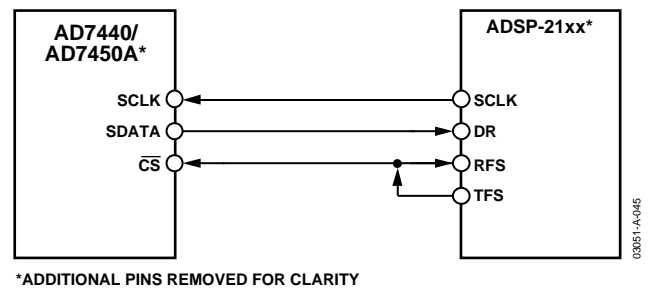

Figure 45. Interfacing to the ADSP-21xx

For example, the ADSP-2111 has a master clock frequency of 16 MHz. If the SCLKDIV register is loaded with the value 3, an SCLK of 2 MHz is obtained and eight master clock periods elapse for every SCLK period. If the timer registers are loaded with the value 803, then 100.5 SCLKs occur between interrupts and subsequently between transmit instructions. This situation results in nonequidistant sampling as the transmit instruction is occurring on a SCLK edge. If the number of SCLKs between interrupts is a whole integer figure of N, equidistant sampling is implemented by the DSP.

AD7440/AD7450A

AD7440/AD7450A to TMS320C5x/C54x

The serial interface on the TMS320C5x/C54x uses a continuous serial clock and frame synchronization signals to synchronize the data transfer operations with peripheral devices like the AD7440/AD7450A. The \overline{CS} input allows easy interfacing between the TMS320C5x/C54x and the AD7440/AD7450A without any glue logic required. The serial port of the TMS320C5x/C54x is set up to operate in burst mode with internal CLKx (Tx serial clock) and FSx (Tx frame sync). The serial port control register (SPC) must have the following setup: FO = 0, FSM = 1, MCM = 1, and TxM = 1. The format bit, FO, may be set to 1 to set the word length to eight bits in order to implement the power-down mode on the AD7440/AD7450A. The connection diagram is shown in Figure 46. For signal processing applications, it is imperative that the frame synchronization signal from the TMS320C5x/C54x provide equidistant sampling.

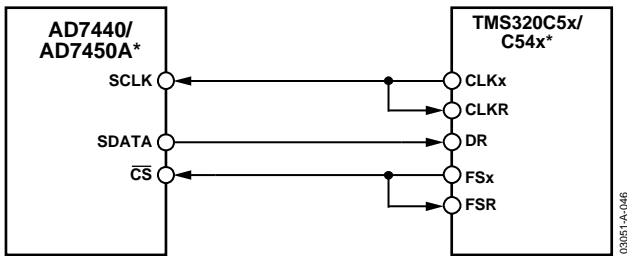

*ADDITIONAL PINS REMOVED FOR CLARITY

Figure 46. Interfacing to the TMS320C5x/C54

AD7440/AD7450A to DSP56xxx

The connection diagram in Figure 47 shows how the device can be connected to the synchronous serial interface (SSI) of the DSP56xxx family of DSPs from Motorola. The SSI is operated in synchronous mode (SYN bit in CRB = 1) with internally generated 1-word frame sync for both Tx and Rx (Bits FSL1 = 0 and FSL0 = 0 in CRB). Set the word length to 16 by setting Bits WL1 = 1 and WL0 = 0 in CRA. To implement power-down mode on the AD7440/AD7450A, the word length can be changed to 8 bits by setting Bits WL1 = 0 and WL0 = 0 in CRA. For signal processing applications, it is imperative that the frame synchronization signal from the DSP56xxx provide equidistant sampling.

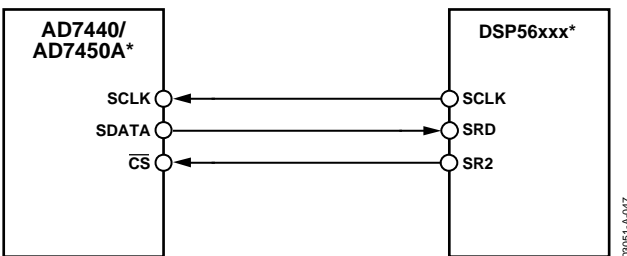

*ADDITIONAL PINS REMOVED FOR CLARITY

Figure 47. Interfacing to the DSP56xxx

GROUNDING AND LAYOUT HINTS

The printed circuit board that houses the AD7440/AD7450A should be designed so that the analog and digital sections are separated and confined to certain areas of the board. This facilitates the use of ground planes that can be easily separated. A minimum etch technique is generally best for ground planes as it gives the best shielding. Digital and analog ground planes should be joined in only one place, a star ground point established as close to the GND pin on the AD7440/AD7450A as possible. Avoid running digital lines under the devices because this couples noise onto the die. The analog ground plane should be allowed to run under the AD7440/AD7450A to avoid noise coupling. The power supply lines to the AD7440/AD7450A should use as large a trace as possible to provide low impedance paths and reduce the effects of glitches on the power supply line.

Fast switching signals like clocks should be shielded with digital ground to avoid radiating noise to other sections of the board, and clock signals should never run near the analog inputs. Avoid crossover of digital and analog signals. Traces on opposite sides of the board should run at right angles to each other. This reduces the effects of feedthrough through the board. A micro-strip technique is by far the best but is not always possible with a double-sided board.

In this technique, the component side of the board is dedicated to ground planes while signals are placed on the solder side. Good decoupling is also important. All analog supplies should be decoupled with 10 μ F tantalum capacitors in parallel with 0.1 μ F capacitors to GND. To achieve the best from these decoupling components, they must be placed as close as possible to the device.

EVALUATING THE AD7440/AD7450A PERFORMANCE

The evaluation board package includes a fully assembled and tested evaluation board, documentation, and software for controlling the board from a PC via the evaluation board controller. The evaluation board controller can be used in conjunction with the AD7440/AD7450A evaluation board, as well as many other Analog Devices evaluation boards ending with the CB designator, to demonstrate and evaluate the ac and dc performance of the AD7440/AD7450A.

The software allows the user to perform ac (fast Fourier transform) and dc (histogram of codes) tests on the device. See the AD7440/AD7450A application note that accompanies the evaluation kit for more information.

OUTLINE DIMENSIONS

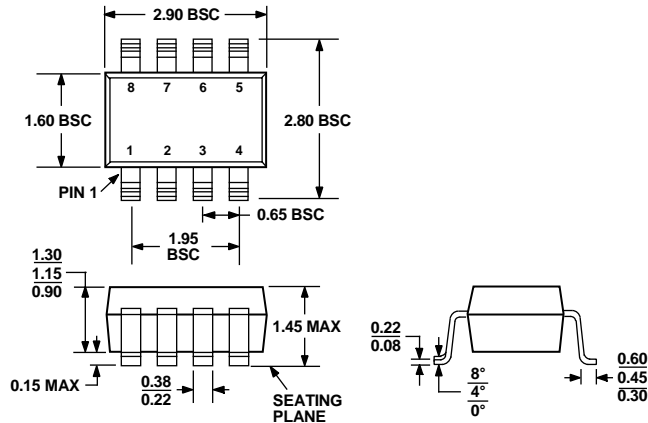

COMPLIANT TO JEDEC STANDARDS MO-178BA

Figure 48. 8-Lead Small Outline Transistor Package [SOT-23] (RT-8)
Dimensions shown in millimeters

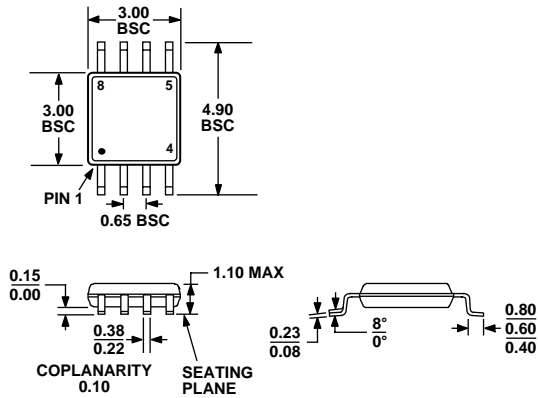

COMPLIANT TO JEDEC STANDARDS MO-187AA

Figure 49. 8-Lead Mini Small Outline Package [MSOP] (RM-8)
Dimensions shown in millimeters

AD7440/AD7450A

ORDERING GUIDE

Model	Temperature Range	Linearity Error (LSB) ¹	Package Option ²	Branding
AD7440BRT-REEL7	-40°C to +85°C	±0.5	RT-8	CTB
AD7440BRT-R2	-40°C to +85°C	±0.5	RT-8	CTB
AD7440BRM	-40°C to +85°C	±0.5	RM-8	CTB
AD7440BRM-REEL7	-40°C to +85°C	±0.5	RM-8	CTB
AD7450ABRT-REEL7	-40°C to +85°C	±1	RT-8	CSB
AD7450ABRT-R2	-40°C to +85°C	±1	RT-8	CSB
AD7450ABRM	-40°C to +85°C	±1	RM-8	CSB
AD7450ABRM-REEL7	-40°C to +85°C	±1	RM-8	CSB
EVAL-AD7440CB ³			Evaluation Board	
EVAL-AD7450ACB ³			Evaluation Board	
EVAL-CONTROL BRD2 ⁴			Controller Board	

¹ Linearity error here refers to integral nonlinearity error.

² RT = SOT-23; RM = MSOP

³ This can be used as a standalone evaluation board or in conjunction with the evaluation board controller for evaluation/demonstration purposes.

⁴ Evaluation board controller. This board is a complete unit allowing a PC to control and communicate with all Analog Devices' evaluation boards ending in the CB designator. For a complete evaluation kit, order the ADC evaluation board (that is, the EVAL-AD7450ACB or EVAL-AD7440CB), the EVAL-CONTROL BRD2, and a 12 V ac transformer. See the AD7440/AD7450A application note that accompanies the evaluation kit for more information.

This datasheet has been download from:

www.datasheetcatalog.com

Datasheets for electronics components.