

# 512Kx8 MONOLITHIC SRAM, SMD 5962-95613

## FEATURES

- Access Times 15, 17, 20, 25, 35, 45, 55ns
- MIL-STD-883 Compliant Devices Available
- Revolutionary, Center Power/Ground Pinout JEDEC Approved
  - 36 lead Ceramic SOJ (Package 100)
  - 36 lead Ceramic Flat Pack (Package 226)
- Evolutionary, Corner Power/Ground Pinout JEDEC Approved
  - 32 pin Ceramic DIP (Package 300)
  - 32 lead Ceramic SOJ (Package 101)
  - 32 lead Ceramic Thinpack™ Flat Pack (Package 321)
- 32 pin, Rectangular Ceramic Leadless Chip Carrier (Package 601)
- Commercial, Industrial and Military Temperature Range
- 5V Power Supply
- Low Power CMOS
- Low Power Data Retention for Battery Back-up Operation
- TTL Compatible Inputs and Outputs

\*This product is subject to change without notice.

### REVOLUTIONARY PINOUT

36 FLAT PACK  
36 CSOJ

TOP VIEW

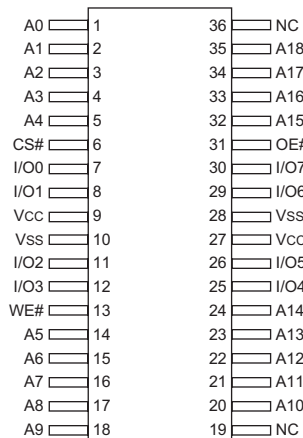

### EVOLUTIONARY PINOUT

32 DIP  
32 CSOJ (DE)  
32 FLAT PACK (FF)

TOP VIEW

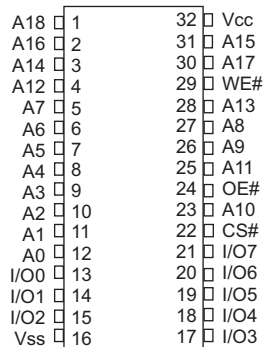

32 CLCC

TOP VIEW

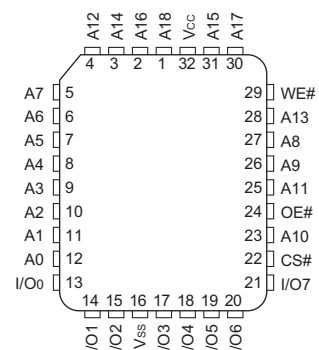

### PIN DESCRIPTION

A0-18	Address Inputs
I/O 0-7	Data Input/Output
CS#	Chip Select
OE#	Output Enable
WE#	Write Enable
V <sub>cc</sub>	+5.0V Power
GND	Ground



## Absolute Maximum Ratings

Parameter	Symbol	Min	Max	Unit
Operating Temperature	T <sub>A</sub>	-55	+125	°C
Storage Temperature Range	T <sub>STG</sub>	-65	+150	°C
Signal Voltage Range to GND	V <sub>G</sub>	-0.5	V <sub>CC</sub> -0.5	V
Junction Temperature	T <sub>J</sub>		150	°C
Supply Voltage Range (V <sub>CC</sub> )	V <sub>CC</sub>	-0.5	7.0	V

## Truth Table

CS#	OE#	WE#	MODE	DATA I/O	POWER
H	X	X	Standby	High Z	Standby
L	L	H	Read	Data Out	Active
L	X	L	Write	Data In	Active
L	H	H	Out Disable	High Z	Active

## Recommended Operating Conditions

Parameter	Symbol	Min	Max	Unit
Supply Voltage	V <sub>CC</sub>	4.5	5.5	V
Input High Voltage	V <sub>IH</sub>	2.2	V <sub>CC</sub> + 0.3	V
Input Low Voltage	V <sub>IL</sub>	-0.3	+0.8	V
Operating Temp. (Mil)	T <sub>A</sub>	-55	+125	°C

## Capacitance

(T<sub>A</sub> = +25°C)

Parameter	Symbol	Conditions	Package	Speed (ns)	Max	Unit
Input capacitance	C <sub>IN</sub>	V <sub>IN</sub> = 0 V, f = 1.0 MHz	32 pin CSOJ, DIP, Flat Pack Evolutionary	15 to 55	20	pF
			32 pin CLCC	15 to 55	15	pF
			36 pin CSOJ & Flat Pack Revolutionary	15 to 35	12	pF
				45 to 55	20	pF
Output capacitance	C <sub>OUT</sub>	V <sub>OUT</sub> = 0 V, f = 1.0 MHz	32 pin CSOJ, DIP, Flat Pack Revolutionary	15 to 55	20	pF
			36 pin CSOJ & Flat Pack Revolutionary	15 to 35	12	pF
				45 to 55	20	pF
					20	pF

This parameter is guaranteed by design but not tested.

## DC Characteristics - CMOS Compatible

(V<sub>CC</sub> = 5.0V, GND = 0V, -55°C ≤ T<sub>A</sub> ≤ 125°C)

Parameter	Symbol	Conditions	Min	Max	Unit
Input Leakage Current	I <sub>LI</sub>	V <sub>CC</sub> = 5.5, V <sub>IN</sub> = GND to V <sub>CC</sub>		10	A
Output Leakage Current	I <sub>LO</sub>	CS# = V <sub>IH</sub> , OE# = V <sub>IH</sub> , V <sub>OUT</sub> = GND TO V <sub>CC</sub>		10	A
Operating Supply Current*	I <sub>CC</sub>	CS# = V <sub>IH</sub> , OE# = V <sub>IH</sub> , f = 5MHz, V <sub>CC</sub> = 5.5,		160	mA
Standby Current	I <sub>SS</sub>	CS# = V <sub>IH</sub> , OE# = V <sub>IH</sub> , f = 5MHz, V <sub>CC</sub> = 5.5		0.45	mA
Output Low Voltage	V <sub>OL</sub>	I <sub>OL</sub> = 6mA for 17 - 35ns, I <sub>OL</sub> = 2.1mA for 45 - 55ns, V <sub>CC</sub> = 4.5		0.4	V
Output High Voltage	V <sub>OH</sub>	I <sub>OH</sub> = -4.0mA for 17 - 35ns, I <sub>OH</sub> = 1.0mA for 45 - 55ns, V <sub>CC</sub> = 4.5	2.4		V

## Data retention characteristics for low power "I" version

Parameter	Symbol	Conditions	Min	Max	Unit
Data Retention Supply Voltage	V <sub>DR</sub>	CS# <sup>1</sup> V <sub>CC</sub> -0.2V	2.0	5.5	V
Low Power Data Retention	I <sub>CCDR1</sub>	V <sub>CC</sub> = 3V		7	mA
Low Power Data Retention	I <sub>CCDR2</sub>	V <sub>CC</sub> = 2V		2	mA



**AC Characteristics**

( $V_{CC} = 5.0V, GND = 0V, -55^{\circ}C \leq T_A \leq 125^{\circ}C$ )

Parameter	Symbol	-15		-17		-20		-25		-35		-45		-55		Unit
		Min	Max	Min	Max	Min	Max	Min	Max	Min	Max	Min	Max	Min	Max	
Read Cycle Time	t <sub>RC</sub>	15		17		20		25		35		45		55		ns
Address Access Time	t <sub>AA</sub>		15		17		20		25		35		45		55	ns
Output Hold from Address Change	t <sub>OH</sub>	0		0		0		0		0		0		0		ns
Chip Select Access Time	t <sub>ACS</sub>		15		17		20		25		35		45		55	ns
Output Enable to Output Valid	t <sub>OE</sub>		8		9		10		12		25		25		25	ns
Chip Select to Output in Low Z	t <sub>ICLZ1</sub>	2		2		2		2		4		4		4		ns
Output Enable to Output in Low Z	t <sub>IOLZ1</sub>	0		0		0		0		0		0		0		ns
Chip Disable to Output in High Z	t <sub>ICHZ1</sub>		8		9		10		12		15		20		20	ns
Output Disable to Output in High Z	t <sub>IOHZ1</sub>		8		9		10		12		15		20		20	ns

**AC Characteristics**

( $V_{CC} = 5.0V, GND = 0V, -55^{\circ}C \leq T_A \leq 125^{\circ}C$ )

Parameter	Symbol	-15		-17		-20		-25		-35		-45		-55		Unit
		Min	Max	Min	Max	Min	Max	Min	Max	Min	Max	Min	Max	Min	Max	
Write Cycle Time	t <sub>WC</sub>	15		17		20		25		35		45		55		ns
Chip Select to End of Write	t <sub>CW</sub>	13		14		14		15		25		35		50		ns
Address Valid to End of Write	t <sub>AW</sub>	13		14		14		15		25		35		50		ns
Data Valid to End of Write	t <sub>DW</sub>	8		9		10		10		20		25		25		ns
Write Pulse Width	t <sub>WP</sub>	13		14		14		15		25		35		40		ns
Address Setup Time	t <sub>AS</sub>	2		2		2		2		2		2		2		ns
Address Hold Time	t <sub>AH</sub>	0		0		0		0		0		5		5		ns
Output Active from End of Write	t <sub>OW1</sub>	2		2		3		4		4		5		5		ns
Write Enable to Output in High Z	t <sub>WHZ1</sub>		8		9		9		10		15		20		25	ns
Data Hold Time	t <sub>DH</sub>	0		0		0		0		0		0		0		ns

1. This parameter is guaranteed by design but not tested.

**AC TEST CIRCUIT**

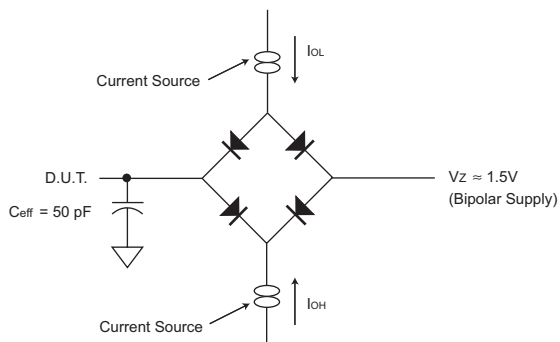

**AC TEST CONDITIONS**

Parameter	Typ	Unit
Input Pulse Levels	$V_{IL} = 0, V_{IH} = 3.0$	V
Input Rise and Fall	5	ns
Input and Output Reference Level	1.5	V
Output Timing Reference Level	1.5	V

Notes:  
 $V_Z$  is programmable from -2V to +7V.  
 $I_{OL}$  &  $I_{OH}$  programmable from 0 to 16mA.  
 Tester Impedance  $Z_0 = 75 \Omega$ .  
 $V_Z$  is typically the midpoint of  $V_{OH}$  and  $V_{OL}$ .  
 $I_{OL}$  &  $I_{OH}$  are adjusted to simulate a typical resistive load circuit.  
 ATE tester includes jig capacitance.



### TIMING WAVEFORM - READ CYCLE

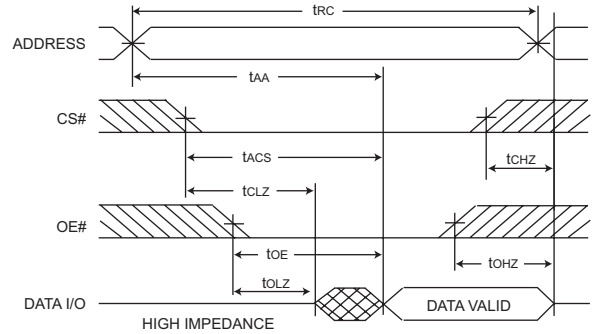
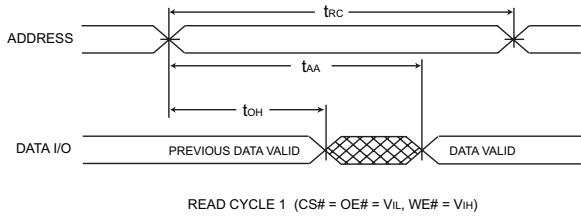

READ CYCLE 2 (WE# = V<sub>IH</sub>)

### WRITE CYCLE - WE# CONTROLLED

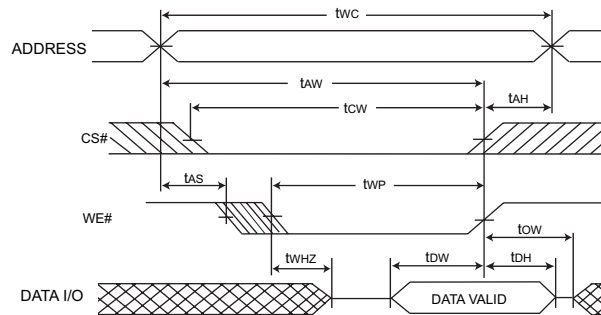

WRITE CYCLE 1, WE# CONTROLLED

### WRITE CYCLE - CS# CONTROLLED

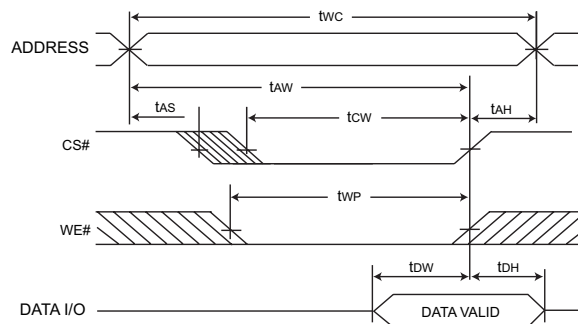

WRITE CYCLE 2, CS# CONTROLLED

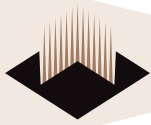

**PACKAGE 100: 36 LEAD, CERAMIC SOJ**

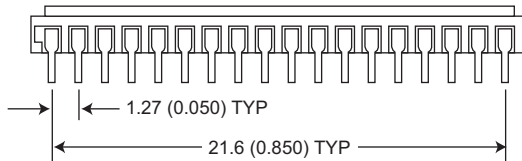
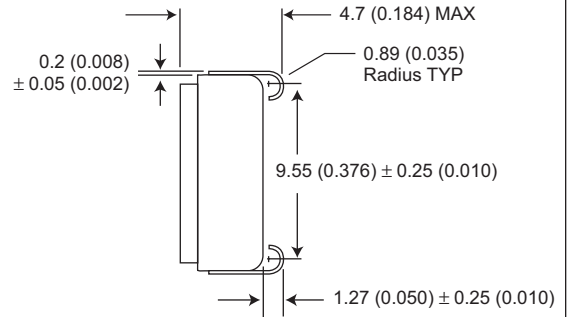
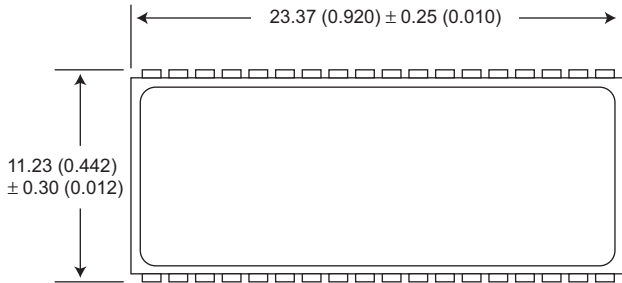

ALL LINEAR DIMENSIONS ARE MILLIMETERS AND PARENTHETICALLY IN INCHES

**PACKAGE 101: 32 LEAD, CERAMIC SOJ**

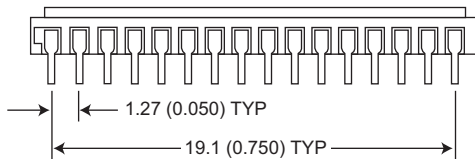
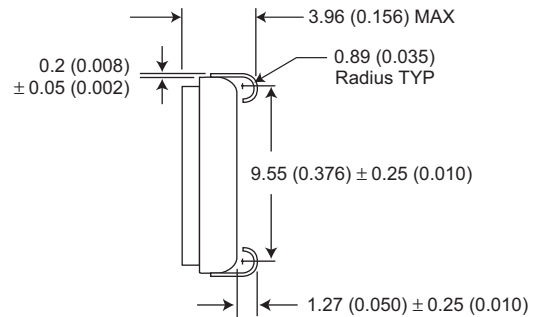
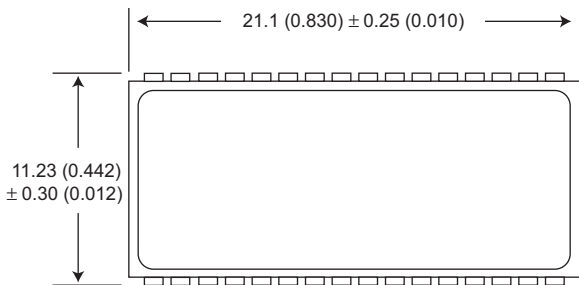

ALL LINEAR DIMENSIONS ARE MILLIMETERS AND PARENTHETICALLY IN INCHES

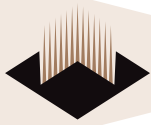

PACKAGE 321: 32 PIN CERAMIC THINPACK™ FLATPACK

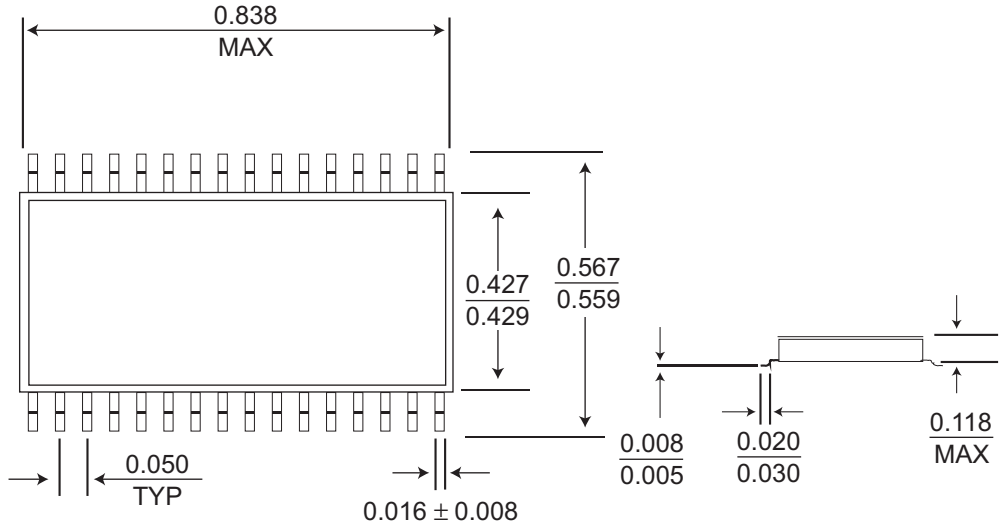

ALL LINEAR DIMENSIONS ARE MILLIMETERS AND PARENTHETICALLY IN INCHES

PACKAGE 226: 36 LEAD, CERAMIC FLAT PACK

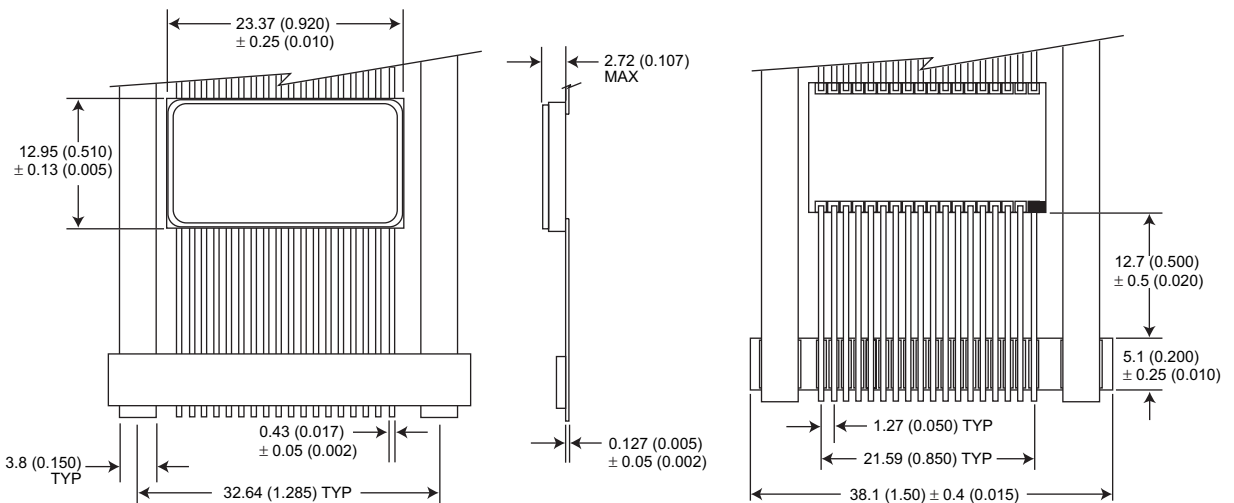

ALL LINEAR DIMENSIONS ARE MILLIMETERS AND PARENTHETICALLY IN INCHES



**PACKAGE 300: 32 PIN, CERAMIC DIP, SINGLE CAVITY SIDE BRAZED**

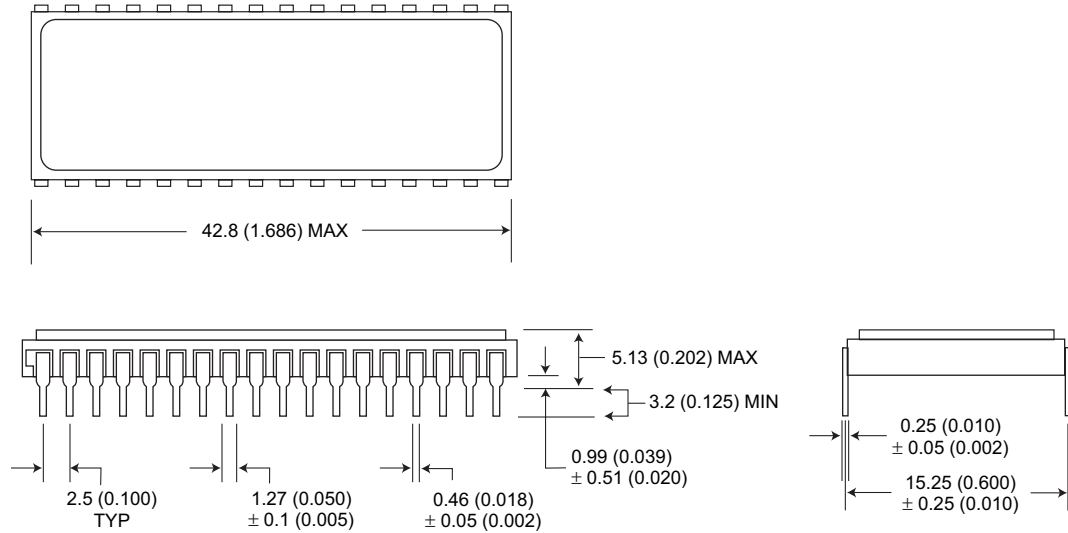

ALL LINEAR DIMENSIONS ARE MILLIMETERS AND PARENTHETICALLY IN INCHES



**PACKAGE 300: 32 PIN, CERAMIC DIP, SINGLE CAVITY SIDE BRAZED**

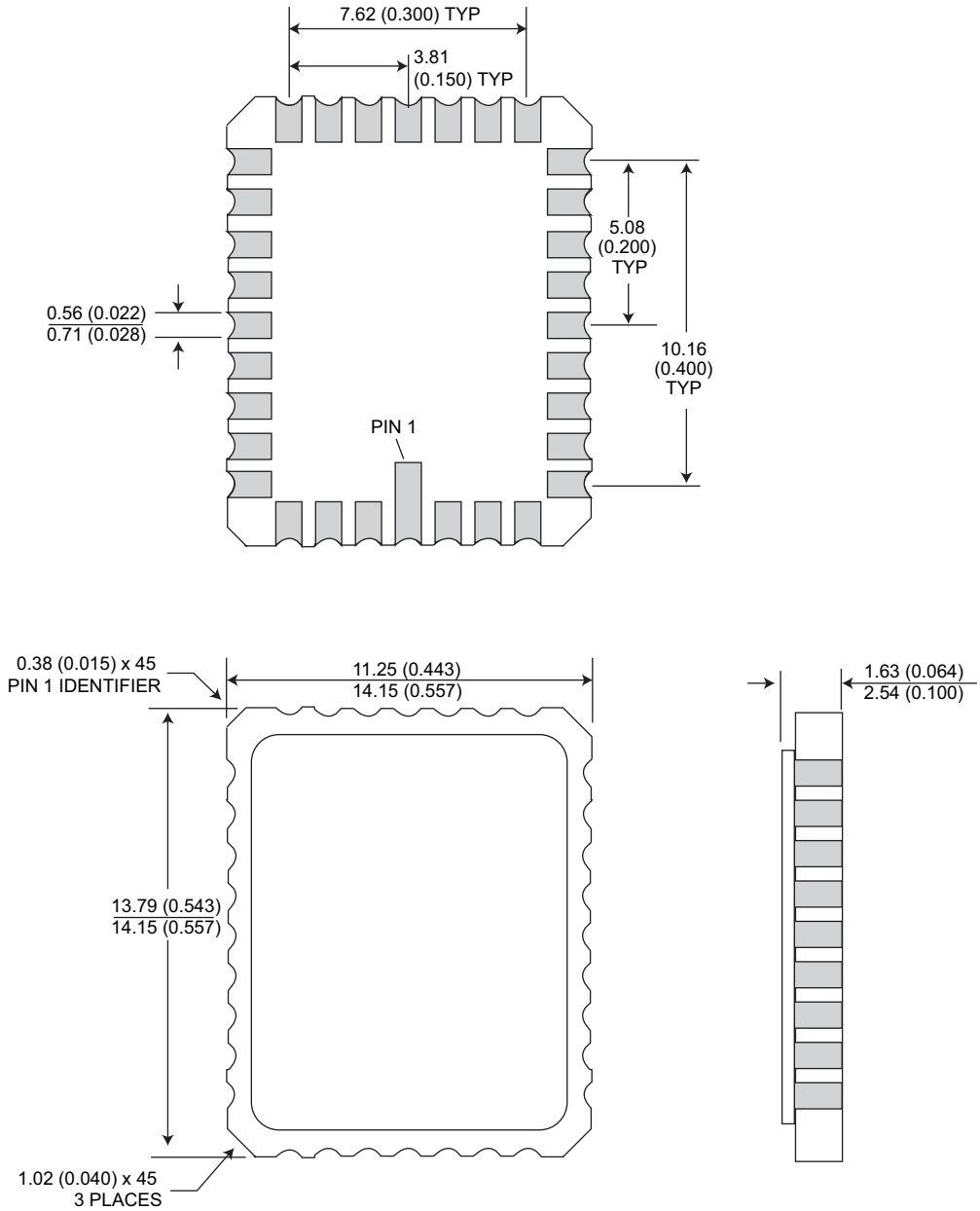

ALL LINEAR DIMENSIONS ARE MILLIMETERS AND PARENTHETICALLY IN INCHES





## ORDERING INFORMATION

W M S 512K 8 X - XXX X X X

WHITE ELECTRONIC DESIGNS CORP. \_\_\_\_\_

MONOLITHIC \_\_\_\_\_

SRAM \_\_\_\_\_

ORGANIZATION, 512K X 8 \_\_\_\_\_

IMPROVEMENT MARK: \_\_\_\_\_

BLANK = STANDARD

L = LOW POWER DATA RETENTION

ACCESS TIME (NS) \_\_\_\_\_

PACKAGE: \_\_\_\_\_

C = 32 PIN CERAMIC 0.600" DIP (PACKAGE 300)

CL = 32 PIN RECTANGULAR CERAMIC LEADLESS CHIP CARRIER (PACKAGE 601)

DE = 32 LEAD CERAMIC SOJ (PACKAGE 101) EVOLUTIONARY

DJ = 36 LEAD CERAMIC SOJ (PACKAGE 100)

F = 36 LEAD CERAMIC FLAT PACK (PACKAGE 226)

FF = 32 LEAD CERAMIC THINPACK™ FLAT PACK (PACKAGE 321)

DEVICE GRADE: \_\_\_\_\_

Q = MIL-STD-883 COMPLIANT

M = MILITARY SCREENED  $-55^{\circ}\text{C} \leq \text{TA} \leq 125^{\circ}\text{C}$

I = INDUSTRIAL  $-40^{\circ}\text{C} \leq \text{TA} \leq 85^{\circ}\text{C}$

C = COMMERCIAL  $0^{\circ}\text{C} \leq \text{TA} \leq 70^{\circ}\text{C}$

LEAD FINISH: \_\_\_\_\_

BLANK = GOLD PLATED LEADS

A = SOLDER DIP LEADS

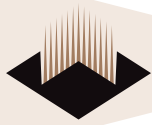

DEVICE TYPE	SPEED	PACKAGE	SMD NO.
512K x 8 SRAM Monolithic	55ns	32 pin DIP (C)	5962-95613 05HYX
512K x 8 SRAM Monolithic	45ns	32 pin DIP (C)	5962-95613 06HYX
512K x 8 SRAM Monolithic	35ns	32 pin DIP (C)	5962-95613 07HYX
512K x 8 SRAM Monolithic	25ns	32 pin DIP (C)	5962-95613 08HYX
512K x 8 SRAM Monolithic	20ns	32 pin DIP (C)	5962-95613 09HYX
512K x 8 SRAM Monolithic	17ns	32 pin DIP (C)	5962-95613 10HYX
512K x 8 SRAM Monolithic	15ns	32 pin DIP (C)	5962-95613 14HYX
512K x 8 SRAM Monolithic	55ns	32 lead SOJ Evol (DE)	5962-95613 05HTX
512K x 8 SRAM Monolithic	45ns	32 lead SOJ Evol (DE)	5962-95613 06HTX
512K x 8 SRAM Monolithic	35ns	32 lead SOJ Evol (DE)	5962-95613 07HTX
512K x 8 SRAM Monolithic	25ns	32 lead SOJ Evol (DE)	5962-95613 08HTX
512K x 8 SRAM Monolithic	20ns	32 lead SOJ Evol (DE)	5962-95613 09HTX
512K x 8 SRAM Monolithic	17ns	32 lead SOJ Evol (DE)	5962-95613 10HTX
512K x 8 SRAM Monolithic	15ns	32 lead SOJ Evol (DE)	5962-95613 14HTX
512K x 8 SRAM Monolithic	55ns	36 lead SOJ (DJ)	5962-95613 05HZX
512K x 8 SRAM Monolithic	45ns	36 lead SOJ (DJ)	5962-95613 06HZX
512K x 8 SRAM Monolithic	35ns	36 lead SOJ (DJ)	5962-95613 07HZX
512K x 8 SRAM Monolithic	25ns	36 lead SOJ (DJ)	5962-95613 08HZX
512K x 8 SRAM Monolithic	20ns	36 lead SOJ (DJ)	5962-95613 09HZX
512K x 8 SRAM Monolithic	17ns	36 lead SOJ (DJ)	5962-95613 10HZX
512K x 8 SRAM Monolithic	15ns	36 lead SOJ (DJ)	5962-95613 14HZX
512K x 8 SRAM Monolithic	55ns	36 lead Flatpack (F)	5962-95613 05HXX
512K x 8 SRAM Monolithic	45ns	36 lead Flatpack (F)	5962-95613 06HXX
512K x 8 SRAM Monolithic	35ns	36 lead Flatpack (F)	5962-95613 07HXX
512K x 8 SRAM Monolithic	25ns	36 lead Flatpack (F)	5962-95613 08HXX
512K x 8 SRAM Monolithic	20ns	36 lead Flatpack (F)	5962-95613 09HXX
512K x 8 SRAM Monolithic	17ns	36 lead Flatpack (F)	5962-95613 10HXX
512K x 8 SRAM Monolithic	15ns	36 lead Flatpack (F)	5962-95613 14HXX