



RISC Microprocessor Multichip Package

OVERVIEW

The WEDC 755/SSRAM multichip package is targeted for high performance, space sensitive, low power systems and supports the following power management features: doze, nap, sleep and dynamic power management.

The WED3C7558M-XBX multichip package consists of:

- 755 RISC processor
- Dedicated 1MB SSRAM L2 cache, configured as 128Kx72
- 21mmx25mm, 255 Ceramic Ball Grid Array (CBGA)
- Core Frequency/L2 Cache Frequency (300MHz/150MHz, 350MHz/175MHz)
- Maximum 60x Bus frequency = 66MHz

The WED3C7558M-XBX is offered in Commercial (0°C to +70°C), industrial (-40°C to +85°C) and military (-55°C to +125°C) temperature ranges and is well suited for embedded applications such as missiles, aerospace, flight computers, fire control systems and rugged critical systems.

* This product is subject to change without notice.

FEATURES

- Footprint compatible with WED3C750A8M-200BX
- Footprint compatible with Motorola MPC 745

FIGURE 1 – MULTI-CHIP PACKAGE DIAGRAM

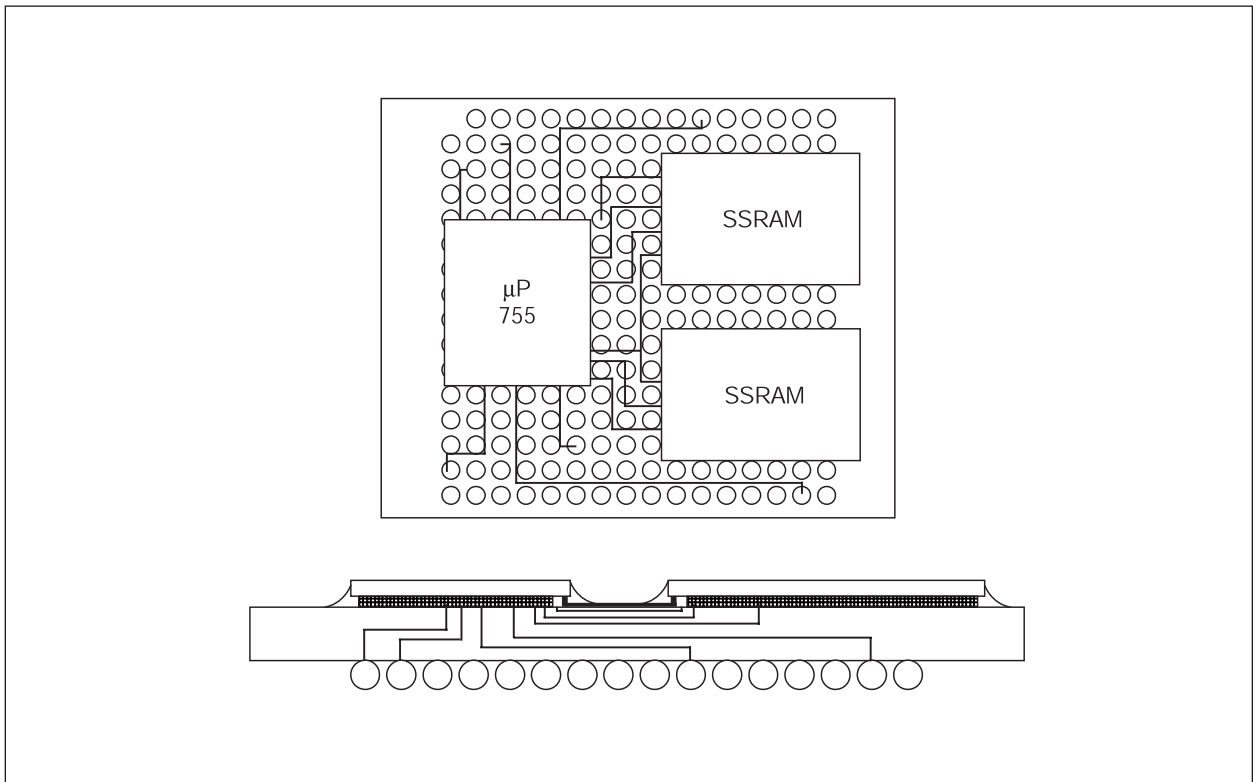



FIGURE 2 – BLOCK DIAGRAM

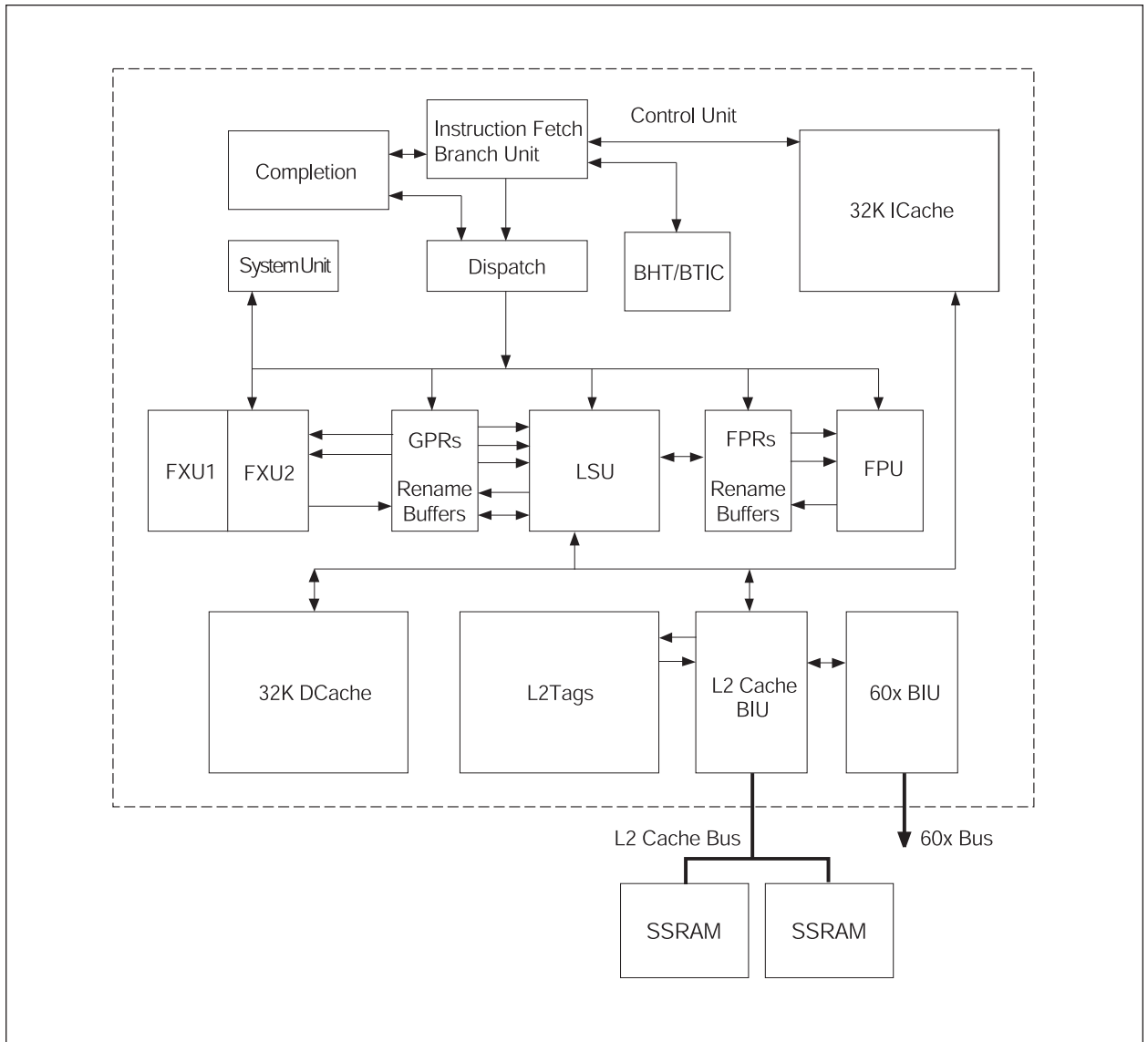



FIGURE 3 – BLOCK DIAGRAM, L2 INTERCONNECT

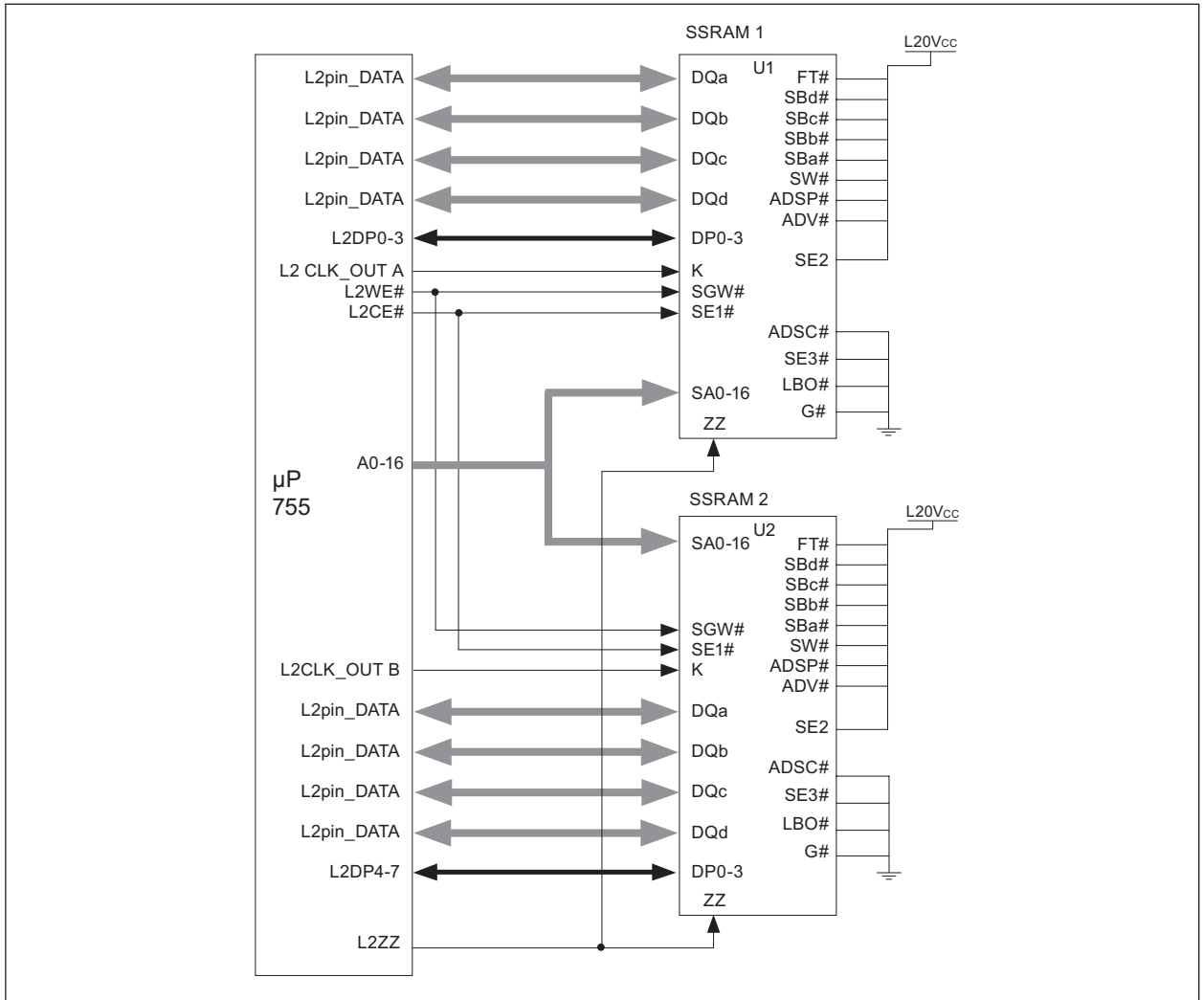
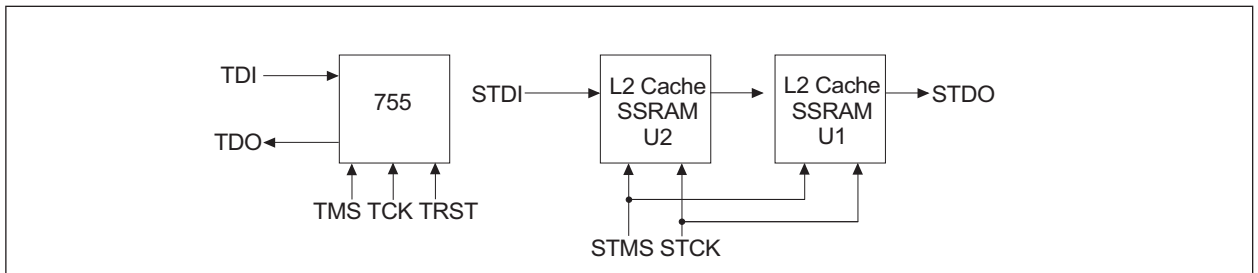

FIGURE 4 – BLOCK DIAGRAM, L2 INTERCONNECT



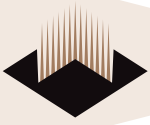
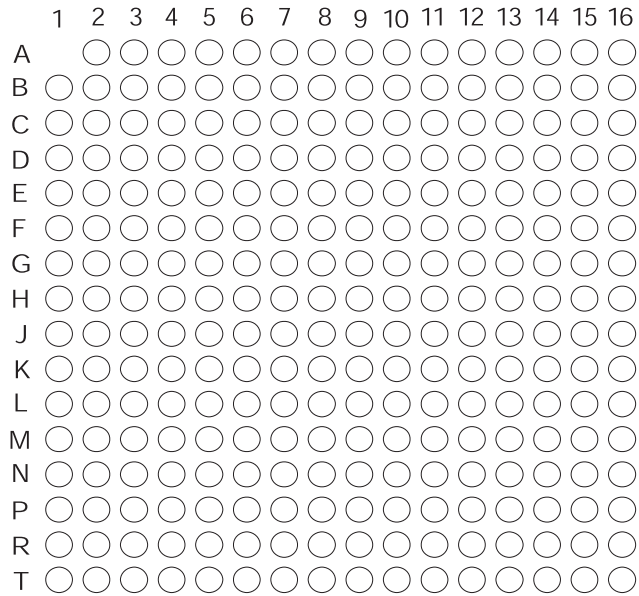
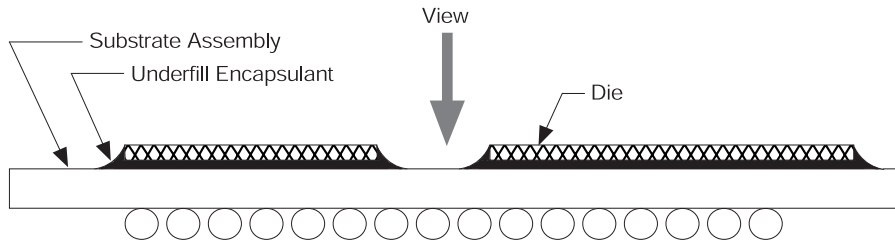

FIGURE 5 – PIN ASSIGNMENTS

Ball assignments of the 255 CBGA package as viewed from the top surface.



Side profile of the CBGA package to indicate the direction of the top surface view.





PACKAGE PINOUT LISTING

Signal Name	Pin Number	Active	I/O	2.0V (7)	3.3V (7)
A[0-31]	C16, E4, D13, F2, D14, G1, D15, E2, D16, D4, E13, G2, E15, H1, E16, H2, F13, J1, F14, J2, F15, H3, F16, F4, G13, K1, G15, K2, H16, M1, J15, P1	High	I/O		
AACK#	L2	Low	Input		
ABB#	K4	Low	I/O		
AP[0-3]	C1, B4, B3, B2	High	I/O		
ARTRY#	J4	Low	I/O		
AV _{cc}	A10	—	—	2.0V	2.0V
BG#	L1	Low	Input		
BR#	B6	Low	Output		
BVSEL (4, 5, 6)	B1	High	Input	GND	3.3V
CI#	E1	Low	Output		
CKSTP_IN#	D8	Low	Input		
CKSTP_OUT#	A6	Low	Output		
CLK_OUT	D7	—	Output		
DBB#	J14	Low	I/O		
DBG#	N1	Low	Input		
DBDIS#	H15	Low	Input		
DBWO#	G4	Low	Input		
DH[0-31]	P14, T16, R15, T15, R13, R12, P11, N11, R11, T12, T11, R10, P9, N9, T10, R9, T9, P8, N8, R8, T8, N7, R7, T7, P6, N6, R6, T6, R5, N5, T5, T4	High	I/O		
DL[0-31]	K13, K15, K16, L16, L15, L13, L14, M16, M15, M13, N16, N15, N13, N14, P16, P15, R16, R14, T14, N10, P13, N12, T13, P3, N3, N4, R3, T1, T2, P4, T3, R4	High	I/O		
DP[0-7]	M2, L3, N2, L4, R1, P2, M4, R2	High	I/O		
DRTRY#	G16	Low	Input		
GBL#	F1	Low	I/O		
GND	C5, C12, E3, E6, E8, E9, E11, E14, F5, F7, F10, F12, G6, G8, G9, G11, H5, H7, H10, H12, J5, J7, J10, J12, K6, K8, K9, K11, L5, L7, L10, L12, M3, M6, M8, M9, M11, M14, P5, P12	—	—	GND	GND
HRESET#	A7	Low	Input		
INT#	B15	Low	Input		
L1_TSTCLK (1)	D11	High	Input		
L2_TSTCLK (1)	D12	High	Input		
L2AV _{cc} (8)	L11	—	—	2.0V	2.0V
L2OV _{cc} (9)	E10, E12, M12, G12, G14, K12, K14	—	—	2.0V	3.3V
L2VSEL (4, 5, 6, 7)	B5	High	Input	*—	3.3V
LSSD_MODE# (1)	B10	Low	Input		
MCP#	C13	Low	Input		
NC (No-connect)	C3, C6, D5, D6, H4, A4, A5, A2, A3	—	—		
OV _{cc} (2)	C7, E5, G3, G5, K3, K5, P7, P10, E7, M5, M7, M10	—	—		
PLL_CFG[0-3]	A8, B9, A9, D9	High	Input		
QACK#	D3	Low	Input		
QREQ#	J3	Low	Output		
RSRV#	D1	Low	Output		
SMI#	A16	Low	Input		
SRESET#	B14	Low	Input		
STCK (10)	B7		Input		
STDI	C8	—	Input	—	—
STDO	J16	—	Output	—	—

* Not supported on this version

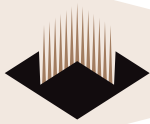

PACKAGE PINOUT LISTING (continued)

Signal Name	Pin Number	Active	I/O	2.0V (7)	3.3V (7)
STMS	B8		Input		
SYSCLK	C9	—	Input		
TA#	H14	Low	Input		
TBEN	C2	High	Input		
TBST#	A14	Low	I/O		
TCK	C11	High	Input		
TDI (6)	A11	High	Input		
TDO	A12	High	Output		
TEA#	H13	Low	Input		
TLBISYNC#	C4	Low	Input		
TMS (6)	B11	High	Input		
TRST# (6)	C10	Low	Input		
TS#	J13	Low	I/O		
TSIZ[0-2]	A13, D10, B12	High	Output		
TT[0-4]	B13, A15, B16, C14, C15	High	I/O		
WT	D2	Low	Output		
V _{cc} (2)	F6, F8, F9, F11, G7, G10, H6, H8, H9, H11, J6, J8, J9, J11, K7, K10, L6, L8, L9	—	—	2.0V	2.0V
VOLDET (3)	F3	Low	Output	—	—

NOTES:

- These are test signals for factory use only and must be pulled up to OV_{cc} for normal machine operation.
- OV_{cc} inputs supply power to the I/O drivers and V_{cc} inputs supply power to the processor core.
- Internally tied to GND in the BGA package to indicate to the power supply that a low-voltage processor is present. This signal is not a power supply pin.
- To allow processor bus I/O voltage changes, provide the option to connect BVSEL and L2VSEL independently to either OV_{cc} (Selects 3.3V Interface) or to GND (Selects 2.0V Interface).
- Uses one of 15 existing no-connects in WEDC's WED3C750A8M-200BX.
- Internal pull up on die.
- OV_{cc} supplies power to the processor bus, JTAG, and all control signals except the L2 cache controls (L2CE, L2WE, and L2ZZ); L2OV_{cc} supplies power to the L2 cache I/O interface (L2ADDR (0-16), L2DATA (0-63), L2DP[0-7] and L2SYNC-OUT) and the L2 control signals and the SSRAM power supplies; and V_{cc} supplies power to the processor core and the PLL and DLL (after filtering to become AV_{cc} and L2AV_{cc} respectively). These columns serve as a reference for the nominal voltage supported on a given signal as selected by the BVSEL/L2VSEL pin configurations and the voltage supplied. For actual recommended value of V_{in} or supply voltages see Recommended Operating Conditions.
- Uses one of 20 existing V_{cc} pins in WEDC's WED3C750A8M-200BX, no board level design changes are necessary. For new designs of WED3C7558M-XBX refer to PLL power supply filtering.
- L2OV_{cc} for future designs that will require 2.0V L2 cache power supply - compatible with existing design using WED3C750A8M-200BX.
- To disable SSRAM TAP controllers without interfering with the normal operation of the devices, STCK should be tied low (GND) to prevent clocking the devices.
- STDI and STMS are internally pulled up and may be left unconnected. Upon power-up the SSRAM devices will come up in a reset state which will not interfere with the operation of the device.

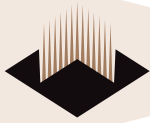

ABSOLUTE MAXIMUM RATINGS

Characteristic	Symbol	Value	Unit	Notes
Core supply voltage	V _{CC}	-0.3 to 2.5	V	(4)
PLL supply voltage	AV _{CC}	-0.3 to 2.5	V	(4)
L2 DLL supply voltage	L2AV _{CC}	-0.3 to 2.5	V	(4)
60x bus supply voltage	OV _{CC}	-0.3 to 3.465	V	(3)
L2 bus supply voltage	L2OV _{CC}	-0.3 to 3.465	V	(3)
Input supply	Processor Bus	V _{IN}	-0.3 to OV _{CC} +0.3	V (2)
	L2 bus	V _{IN}	-0.3 to L2OV _{CC} +0.3	V (2)
	JTAG Signals	V _{IN}	-0.3 to 3.6	V (2)
Storage temperature range	T _{STG}	-55 to 150	°C	

- NOTES:
1. Functional and tested operating conditions are given in Operating Conditions table. Absolute maximum ratings are stress ratings only, and functional operation at the maximums is not guaranteed. Stresses beyond those listed may affect device reliability or cause permanent damage to the device.
 2. **Caution:** V_{IN} must not exceed OV_{CC} by more than 0.3V at any time including during power-on reset.
 3. **Caution:** OV_{CC}/L2OV_{CC} must not exceed V_{CC}/AV_{CC}/L2AV_{CC} by more than 1.6 V at any time including during power-on reset.
 4. **Caution:** V_{CC}/AV_{CC}/L2AV_{CC} must not exceed L2OV_{CC}/OV_{CC} by more than 0.4 V at any time including during power-on reset.

RECOMMENDED OPERATING CONDITIONS

Characteristic	Symbol	Recommended Value	Unit	
Core supply voltage	V _{CC}	2.0 ± 100mV	V	
PLL supply voltage	AV _{CC}	2.0 ± 100mV	V	
L2 DLL supply voltage	L2AV _{CC}	2.0 ± 100mV	V	
Processor bus supply voltage	BVSEL = 0	OV _{CC}	2.0 ± 100mV	V
	BVSEL = 1	OV _{CC}	3.3 ± 165mV	V
L2 bus supply voltage	L2VSEL = 1	L2OV _{CC}	3.3 ± 165mV	V
Input Voltage	Processor bus	V _{IN}	GND to OV _{CC}	V
	JTAG Signals	V _{IN}	GND to OV _{CC}	V

NOTE: These are the recommended and tested operating conditions. Proper device operation outside of these conditions is not guaranteed.



POWER CONSUMPTION

$V_{CC} = AV_{CC} = 2.0 \pm 0.1V$ Vdc, $OV_{CC} = 3.3V \pm 5\%$ Vdc, GND = 0 Vdc, $0 \leq T_J < 105^\circ C$

		Processor (CPU) Frequency/L2 Frequency		Unit	Notes
		300/150 MHz	350/175MHz		
Full-on Mode	Typical	4.1	4.6	W	1, 3
	Maximum	6.7	7.9	W	1, 2
Doze Mode	Maximum	2.5	2.8	W	1, 2
Nap Mode	Maximum	1700	1800	mW	1, 2
Sleep Mode	Maximum	1200	1300	mW	1, 2
Sleep Mode-PLL and DLL Disabled	Maximum	500	500	mW	1, 2

- NOTES:
- These values apply for all valid 60x bus and L2 bus ratios. The values do not include OV_{CC} ; AV_{CC} and $L2AV_{CC}$ supplying power. OV_{CC} power is system dependent, but is typically <10% of V_{CC} power. Worst case power consumption, for $AV_{CC}=15mW$ and $L2AV_{CC}=15mW$.
 - Maximum power is measured at $V_{CC}=2.1V$ while running an entirely cache-resident, contrived sequence of instructions which keep the execution units maximally busy.
 - Typical power is an average value measured at $V_{CC}=AV_{CC}=L2AV_{CC}=2.0V$, $OV_{CC}=L2OV_{CC}=3.3V$ in a system, executing typical applications and benchmark sequences.

L2 CACHE CONTROL REGISTER (L2CR)

The L2 cache control register, shown in Figure 5, is a supervisor-level, implementation-specific SPR used to configure and operate the L2 cache. It is cleared by hard reset or power-on reset.

FIGURE 5 – L2 CACHE CONTROL REGISTER (L2CR)

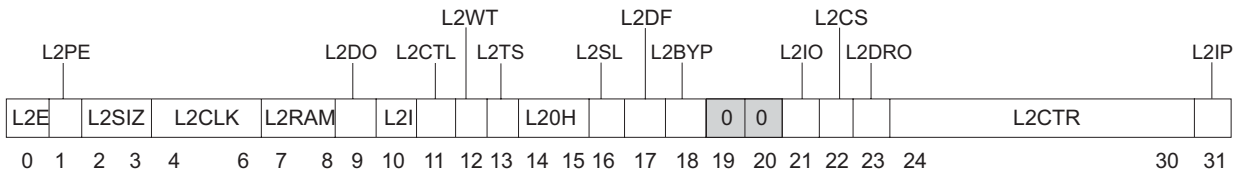

The L2CR bits are described in Table 1.





TABLE 1: L2CR BIT SETTINGS

Bit	Name	Function
0	L2E	L2 enable. Enables L2 cache operation (including snooping) starting with the next transaction the L2 cache unit receives. Before enabling the L2 cache, the L2 clock must be configured through L2CR[2CLK], and the L2 DLL must stabilize. All other L2CR bits must be set appropriately. The L2 cache may need to be invalidated globally.
1	L2PE	L2 data parity checking enable. Enables parity generation and checking for the L2 data RAM interface. When disabled, generated parity is always zeros. L2 Parity is supported by WEDC's WED3C7558M-XBX, but is dependent on application.
2–3	L2SIZ	L2 size — Should be set according to the size of the L2 data RAMs used. 11 1 Mbyte - Setting for WED3C7558M-XBX
4–6	L2CLK	L2 clock ratio (core-to-L2 frequency divider). Specifies the clock divider ratio based from the core clock frequency that the L2 data RAM interface is to operate at. When these bits are cleared, the L2 clock is stopped and the on-chip DLL for the L2 interface is disabled. For nonzero values, the processor generates the L2 clock and the on-chip DLL is enabled. After the L2 clock ratio is chosen, the DLL must stabilize before the L2 interface can be enabled. The resulting L2 clock frequency cannot be slower than the clock frequency of the 60x bus interface. 000 L2 clock and DLL disabled 001 ÷ 1 010 ÷ 1.5 011 Reserved 100 ÷ 2 101 ÷ 2.5 110 ÷ 3 111 Reserved
7–8	L2RAM	L2 RAM type — Configures the L2 RAM interface for the type of synchronous SRAMs used: • Pipelined (register-register) synchronous burst SRAMs that clock addresses in and clock data out The 755 does not burst data into the L2 cache, it generates an address for each access. 10 Pipelined (register-register) synchronous burst SRAM – Setting for WED3C7558M-XBX
9	L2DO	L2 data only. Setting this bit enables data-only operation in the L2 cache. For this operation, instruction transactions from the L1 Instruction cache already cached in the L2 cache can hit in the L2, but new instruction transactions from the L1 instruction cache are treated as cache-inhibited (bypass L2 cache, no L2 checking done). When both L2DO and L2IO are set, the L2 cache is effectively locked (cache misses do not cause new entries to be allocated but write hits use the L2).
10	L2I	L2 global invalidate. Setting L2I invalidates the L2 cache globally by clearing the L2 status bits. This bit must not be set while the L2 cache is enabled. See Motorola's User manual for L2 Invalidation procedure.
11	L2CTL	L2 RAM control (ZZ enable). Setting L2CTL enables the automatic operation of the L2ZZ (low-power mode) signal for cache RAMs. Sleep mode is supported by the WED3C7558M-XBX . While L2CTL is asserted, L2ZZ asserts automatically when the device enters nap or sleep mode and negates automatically when the device exits nap or sleep mode. This bit should not be set when the device is in nap mode and snooping is to be performed through deassertion of QACK#.
12	L2WT	L2 write-through. Setting L2WT selects write-through mode (rather than the default write-back mode) so all writes to the L2 cache also write through to the system bus. For these writes, the L2 cache entry is always marked as exclusive rather than modified. This bit must never be asserted after the L2 cache has been enabled as previously-modified lines can get remarked as exclusive during normal operation.
13	L2TS	L2 test support. Setting L2TS causes cache block pushes from the L1 data cache that result from dcbf and dcbst instructions to be written only into the L2 cache and marked valid, rather than being written only to the system bus and marked invalid in the L2 cache in case of hit. This bit allows a dcbz / dcbf instruction sequence to be used with the L1 cache enabled to easily initialize the L2 cache with any address and data information. This bit also keeps dcbz instructions from being broadcast on the system and single-beat cacheable store misses in the L2 from being written to the system bus. 0: Setting for the L2 Test support as this bit is reserved for tests.
14–15	L2OH	L2 output hold. These bits configure output hold time for address, data, and control signals driven to the L2 data RAMs. 00: Least Hold Time – Setting for WED3C7558M-XBX

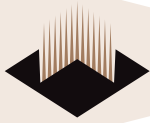

TABLE 1: L2CR BIT SETTINGS

Bit	Name	Function
16	L2SL	L2 DLL slow. Setting L2SL increases the delay of each tap of the DLL delay line. It is intended to increase the delay through the DLL to accommodate slower L2 RAM bus frequencies. 0: Setting for WED3C7558M-XBX because L2 RAM interface is operated above 100 MHz.
17	L2DF	L2 differential clock. This mode supports the differential clock requirements of late-write SRAMs. 0: Setting for WED3C7558M-XBX because late-write SRAMs are not used.
18	L2BYP	L2 DLL bypass is reserved. 0: Setting for WED3C7558M-XBX
19-20	—	Reserved. These bits are implemented but not used; keep at 0 for future compatibility.
21	L2IO	L2 Instruction-only. Setting this bit enables instruction-only operation in the L2 cache. For this operation, data transactions from the L1 data cache already cached in the L2 cache can hit in the L2 (including writes), but new data transactions (transactions that miss in the L2) from the L1 data cache are treated as cache-inhibited (bypass L2 cache, no L2 checking done). When both L2DO and L2IO are set, the L2 cache is effectively locked (cache misses do not cause new entries to be allocated but write hits use the L2). Note that this bit can be programmed dynamically.
22	L2CS	L2 Clock Stop. Setting this bit causes the L2 clocks to the SRAMs to automatically stop whenever the MPC755 enters nap or sleep modes, and automatically restart when exiting those modes (including for snooping during nap mode). It operates by asynchronously gating off the L2CLK_OUT [A:B] signals while in nap or sleep mode. The L2SYNC_OUT/SYNC_IN path remains in operation, keeping the DLL synchronized. This bit is provided as a power-saving alternative to the L2CTL bit and its corresponding ZZ pin, which may not be useful for dynamic stopping/restarting of the L2 interface from nap and sleep modes due to the relatively long recovery time from ZZ negation that the SRAM requires.
23	L2DRO	L2 DLL rollover. Setting this bit enables a potential rollover (or actual rollover) condition of the DLL to cause a checkstop for the processor. A potential rollover condition occurs when the DLL is selecting the last tap of the delay line, and thus may risk rolling over to the first tap with one adjustment while in the process of keeping synchronized. Such a condition is improper operation for the DLL, and, while this condition is not expected, it allows detection for added security. This bit can be set when the DLL is first enabled (set with the L2CLK bits) to detect rollover during initial synchronization. It could also be set when the L2 cache is enabled (with L2E bit) after the DLL has achieved its initial lock.
24–30	L2CTR	L2 DLL counter (read-only). These bits indicate the current value of the DLL counter (0 to 127). They are asynchronously read when the L2CR is read, and as such should be read at least twice with the same value in case the value is asynchronously caught in transition. These bits are intended to provide observability of where in the 128-bit delay chain the DLL is at any given time. Generally, the DLL operation should be considered at risk if it is found to be within a couple of taps of its beginning or end point (tap 0 or tap 128).
31	L2IP	L2 global invalidate in progress (read only)—See the Motorola user's manual for L2 Invalidation procedure.



PLL POWER SUPPLY FILTERING

The AV_{CC} and $L2AV_{CC}$ power signals are provided on the WED3C7558M-XBX to provide power to the clock generation phase-locked loop and L2 cache delay-locked loop respectively. To ensure stability of the internal clock, the power supplied to the AV_{CC} input signal should be filtered of any noise in the 500kHz to 10 MHz resonant frequency range of the PLL. A circuit similar to the one shown in Figure 6 using surface mount capacitors with minimum Effective Series Inductance (ESL) is recommended. Multiple small capacitors of equal value

are recommended over a single large value capacitor. The circuit should be placed as close as possible to the AV_{CC} pin to minimize noise coupled from nearby circuits. An identical but separate circuit should be placed as close as possible to the $L2AV_{CC}$ pin. It is often possible to route directly from the capacitors to the AV_{CC} pin, which is on the periphery of the 255 BGA footprint, without the inductance of vias. The $L2AV_{CC}$ pin may be more difficult to route but is proportionately less critical.

FIGURE 6 – POWER SUPPLY FILTER CIRCUIT

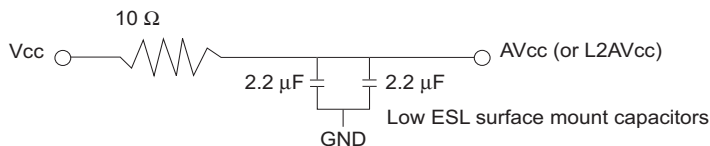



PACKAGE DESCRIPTION

Package Outline	21x25mm
Interconnects	255 (16x16 ball array less one)
Pitch	1.27mm
Maximum module height	3.90mm
Ball diameter	0.8mm

PACKAGE DIMENSIONS 255 BALL GRID ARRAY

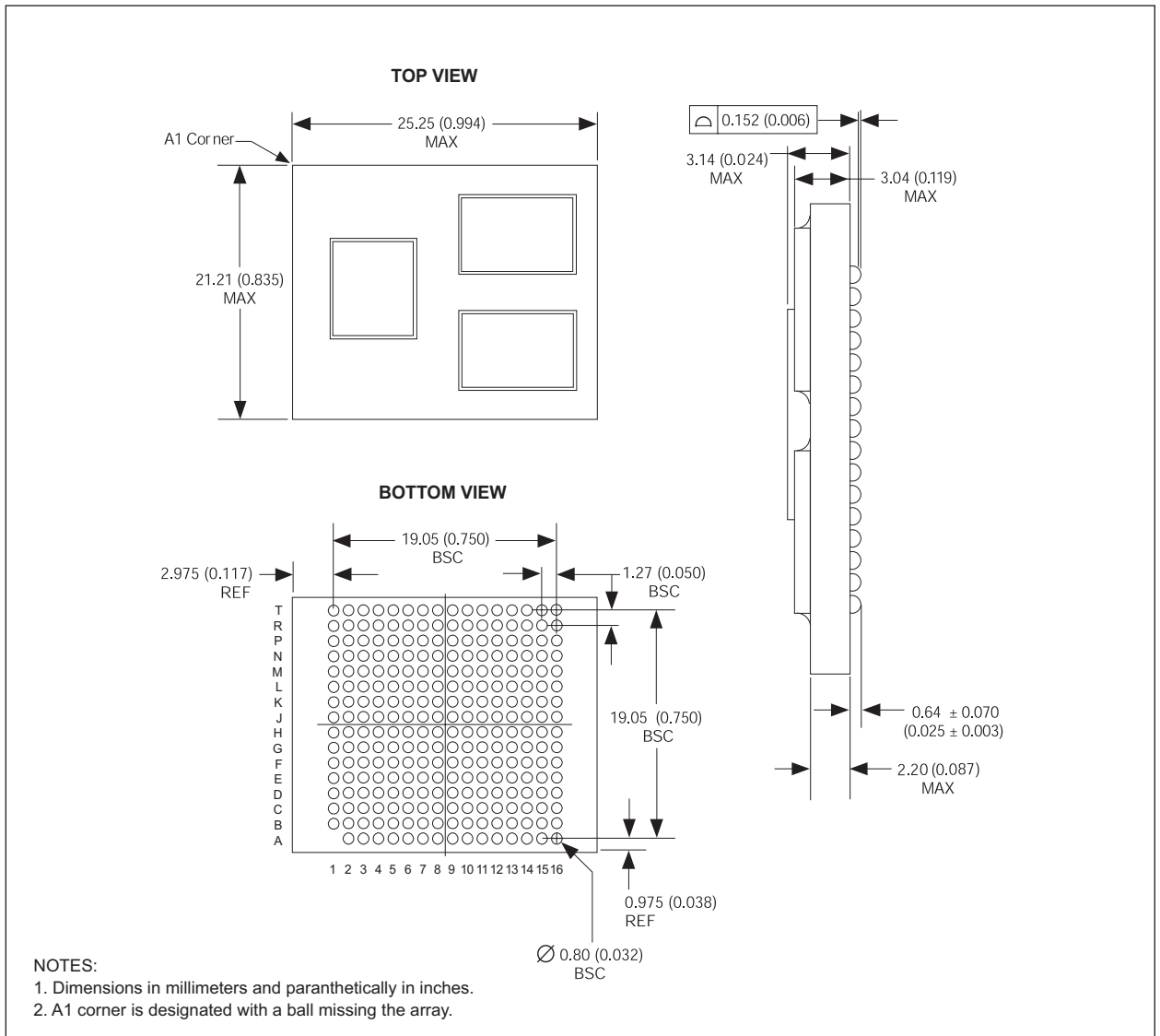



Ordering Information

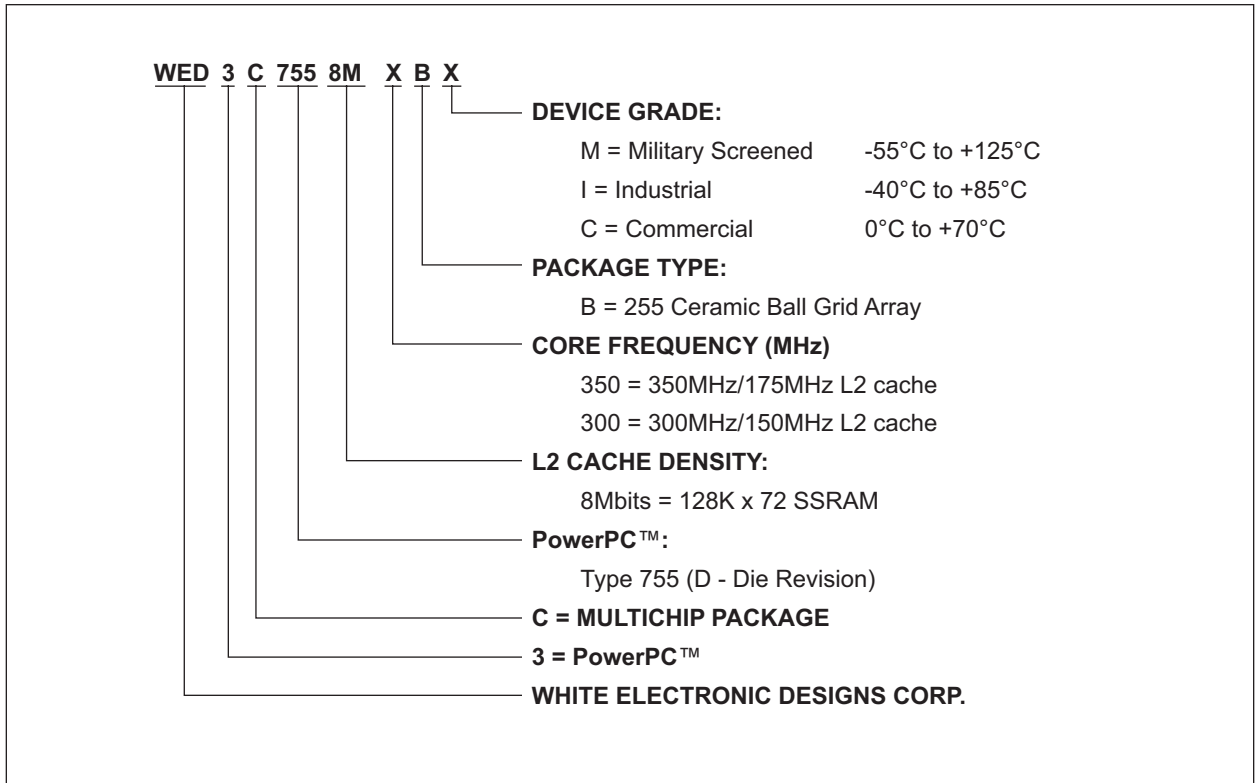

PowerPC™ is a trademark of International Business Machine Corp.