

Stratum 3E Timing Module (STM-S3E)

**CONNOR
WINFIELD**

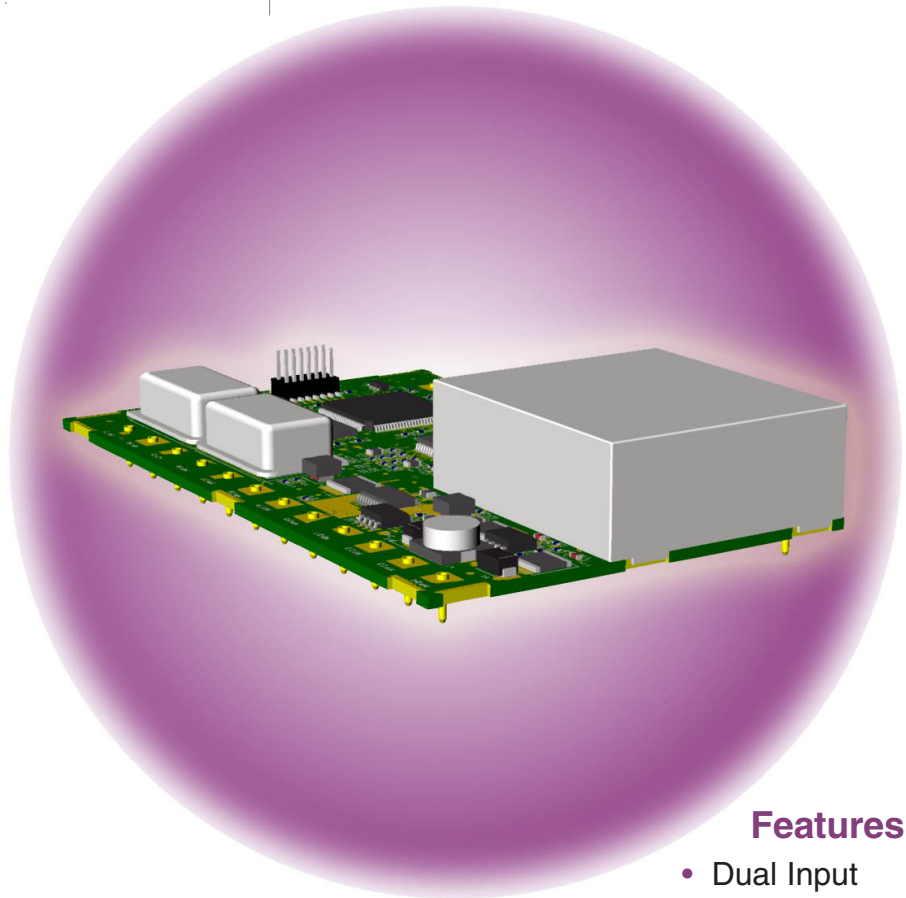

2111 Comprehensive Drive
Aurora, Illinois 60505
Phone: 630-851-4722
Fax: 630-851-5040
www.conwin.com



Application

The Connor-Winfield Stratum 3E Simplified Control Timing Module acts as a complete system clock module for Stratum 3E timing applications in accordance with GR-1244-CORE, Issue 2, GR-253-CORE, Issue 3, and ITU-T G.812, Option III.

Connor-Winfield's Stratum 3E Timing module helps reduce the cost of your design by minimizing your development time and maximizing your control of the system clock with our simplified design.

Features

- Dual Input References
- Hitless Switch Over
- 1.544 MHz -38.88 MHz
- 8 kHz Output
- 12 ppb Composite Hold Over Mode
- Fast Acquisition Mode
- Hold Over Good Indicator
- Phase Buildout Indicator
- LOR Alarms
- Reference Frequency Limit Alarm

Bulletin	TM012
Page	1 of 16
Revision	P06
Date	20 MAY 02
Issued By	MBATTS

General Description

Connor-Winfield's STM-S3E timing module provides Stratum 3E synchronization for a complete system clock solution in a single module in accordance with GR-1244-CORE Issue 2, GR-253-CORE Issue 3, and ITU-T G.812 Option III. The STM-S3E provides a reliable network element clock reference to line cards used in TDM, PDH, SONET, and SDH application environments. Typical applications include digital cross talks, DSLAMs, ADMs, multiservice platforms, switches and routers.

The STM-S3E meets 12 ppb Hold Over requirements over 0° – 70°C temperature range. The 5V power requirement will draw a maximum of 1.2 A during an initial start-up period and then drop to a typical current of 800 mA during normal operating conditions. It accepts two 8 kHz input references and can be manufactured to supply a fixed frequency from 1.544 MHz to 38.88 MHz.

The STM-S3E offers 4 user selectable modes of operation, Reference 1, Reference 2, Hold Over and Free Run. Mode of operation is selected by two control pins (Table 6). The current mode of operation is also indicated by two status pins (Table 7). Free Run is the default mode if no control signals are asserted on the control pins.

Reference 1 mode and Reference 2 mode are the two primary operating modes. When the module is locked to a valid reference, any time after initial power up or reset, the module is considered to be in the normal operating mode. During normal operation the output frequency is phase locked to the input reference frequency. The offset between the input and output is dependant upon the amount of noise that is present on the reference signal. For input tolerances, refer to Table 4.

Hold Over mode provides a stable frequency that is guaranteed to be within ± 0.012 ppm over the entire temperature range for the first 24 hours after entry into Hold Over. Hold Over is valid 701 seconds after a reference is selected and continues to do a running average every 8 seconds for the next 1049 seconds. Long-term Hold Over values are based on a 1049 second moving window average. Hold Over values are not updated during LOR or during Fast Acquisition mode. Hold Over values are buffered for at least 32 seconds to allow enough time to respond to the RFL alarm.

Free Run is a mode of operation in which the module is not locked to a reference and its output frequency is solely dependent on the initial frequency setting of the internal oscillator. The output frequency in Free Run is guaranteed to be ± 4.6 ppm of the nominal frequency.

A fifth, automatic mode of operation is Fast Acquisition mode. Fast Acquisition mode is entered whenever Reference 1 or 2 has been selected. After a new reference has been selected, the module uses internal filtering that limits the frequency movement to less than 2.9 ppm/sec. By 600 seconds the module switches to a slower 0.001Hz filter. While in normal mode, if the phase error is greater than 20 μ s, Fast Acquisition mode will be initiated. Fast Acquisition mode is further described as fast start mode in GR-1244-CORE, Issue 3, sec 3.6.

The STM-S3E may be reset by asserting a logic low signal

to the Reset pin or cycling the power. Using the Reset pin for a manual reset is the recommend method for resetting the module. Resetting the module by cycling the power requires more time due to the restablization of the internal ovenized oscillator.

The STM-S3E provides the user with non-interruptive Tri-State capabilities. By asserting a logic high signal to the Tri-State pin, the user is able to Tri-State all outputs. While in Tri-State, the module continues normal operations and accepts all normal inputs. When the module is released from Tri-State, all output signals are valid.

The STM-S3E module provides three output frequencies. The Sync_Out is the primary synchronized output. It is phase locked to the input reference during normal operation and is set to a fixed frequency when operating in Hold Over or Free Run. Clock_Out provides a frequency output that comes from an independent, undisciplined, free running oscillator that is ± 4.6 ppm from the nominal frequency. This output is typically used for reference frequency qualification. The 8 kHz output is derived from the Sync_Out output.

The STM-S3E module provides a variety of alarm indicators to alert the user to multiple conditions that may affect the overall performance of their system. The LOR (Loss of Reference) alarm indicates that the active reference has been lost. RFL (Reference Frequency Limit) indicates that the Sync_Out frequency is 15 ppm or more from the Free Run frequency. The PBO (Phase Build Out) pin indicates that a phase transient greater than 3.4 μ s over any 0.1 second interval has occurred. The PBO indicator will remain high as long as the phase transient condition exists.

The Mode Alarm pin is used to indicate that the module is not in a normal operating mode. Conditions that will cause the Mode Alarm to go high are Hold Over, Free Run, Fast Acquisition Modes or when Phase Build Out has been active for more than 0.4 seconds. During the latter condition, both the Mode Alarm indicator and the PBO indicator will be high. See Table 8 for a full description of input control pins and output indicator pins.

The Hold Over Good pin indicates that an initial average has been acquired to provide a qualified Hold Over frequency. The module requires approximately 700 seconds from any reference switch or mode switch to a new reference to reacquire a valid average before the indicator goes high (Fig. 17). Initially, entry into Hold Over prior to this will result in a Free Run frequency. After the first Hold Over Good indication, entry into Hold Over will be the last valid Hold Over frequency.

The STM-S3E meets the requirements for wander generation and wander transfer as required by GR-1244, sections 5.3 and 5.4. Figures 4, 5 and 6 show typical results. It also complies with phase transient requirements during Reference Rearrangement, Entry into Hold Over, and 1 μ s transient. See figures 7-9 for typical performance results and requirement masks. Input jitter is attenuated at about 20 dB/decade to minimize jitter noise from being passed to other network elements or clocks. Figure 10 illustrates the STM-S3E's typical roll off of attenuated jitter.

Table 1

Absolute Maximum Rating

Symbol	Parameter	Minimum	Nominal	Maximum	Units	Notes
V_{CC}	Power Supply Voltage	-0.5		5.5	Volts	1.0
V_I	Input Voltage	-0.5		5.5	Volts	1.0
T_s	Storage Temperature	-40		85	deg. C	1.0
V_{TS}	Voltage Applied to Tri-State Output	-0.5		5.5	Volts	

Table 2

Recommended Operating Conditions

Symbol	Parameter	Minimum	Nominal	Maximum	Units	Notes
V_{CC}	Power Supply Voltage	4.75		5.25	Volts	
V_{IH}	High level input voltage - CMOS	2.0		5.25	Volts	2.0
V_{IL}	Low level input voltage - CMOS	0		0.8	Volts	

Table 3

DC Characteristics

Symbol	Parameter	Minimum	Nominal	Maximum	Units	Notes
V_{OH}	High level output voltage, $I_{OH} = -4.0\text{mA}$, $V_{CC} = \text{min.}$	2.4	3.3	3.6	Volts	3.0
V_{OL}	Low level output voltage, $I_{OL} = 8.0\text{mA}$, $V_{CC} = \text{max.}$			0.4	Volts	

Table 4

Specifications

Parameter	Specifications	Notes
Frequency Range (Sync_Out)	1.544 MHz - 38.88 MHz	
Frequency Range (Clk_Out)	1.544 MHz - 51.84 MHz	
Supply Current	800 mA typical, 1.2 A during warm-up (Maximum)	
Timing Reference Inputs	GR-1244-CORE 3.2.1	
Jitter, Wander and Phase Transient Tolerances	GR-1244-CORE 4.2-4.4, GR-253-CORE 5.4.4.3.6	
Wander Generation	GR-1244-CORE 5.3, GR-253-CORE 5.4.4.3.2	
Wander Transfer	GR-1244-CORE 5.4	
Jitter Generation	GR-1244-CORE 5.5, GR-253-CORE 5.6.2.3	
Jitter Transfer	GR-1244-CORE 5.5, GR-253-CORE 5.6.2.1	
Phase Transients	GR-1244-CORE 5.6, GR-253-CORE 5.4.4.3.3	
Sync_Out (Pin #15) Free Run Accuracy	±4.6 ppm over temperature range	
Clock_Out (Pin #18) Accuracy	±4.6 ppm over temperature range	
Hold Over Stability	±0.012 ppm	4.0
Initial Offset	±0.001 ppm	
Temperature	±0.010 ppm	
Drift	±0.001 ppm	
Maximum Hold Over History	1049 seconds	
Minimum Time for Hold Over	701 seconds after a reference rearrangement	
Pull-in/ Hold-in Range	±17 ppm from Free Run frequency	5.0
Lock Time	700 sec.	
Lock Accuracy	0.001 ppm (GR-1244-CORE 2.8)	6.0
RFL Alarm Limit	±15 ppm from Free Run frequency	

NOTES:

- 1.0: Stresses beyond those listed under Absolute Maximum Rating may cause damage to the device. Operation beyond Recommended Conditions is not implied.
 2.0: Inputs are 3.3V CMOS, 5V tolerant
 3.0: Logic is 3.3V CMOS

- 4.0: Hold Over stability is the cumulative fractional frequency offset as described by GR-1244-CORE, 5.2
 5.0: Pull-in Range is the maximum frequency deviation from nominal clock rate on the reference inputs to the timing module that can be overcome to pull into synchronization with the reference
 6.0: After 700 seconds at stable temperature (±5° F)



Pin Description

Table 5

Pin #	Connection	Description
1	Status 0	Mode indicator.
2	Status 1	Mode indicator.
3	LOR	Loss of Reference indicator. 1 = active reference has been lost.
4	PBO	Phase build out indicator. 1 = module is in a phase build out condition.
5	GND	Ground
6	8 kHz Output	Derived from Sync_Out.
7	Reset	Master reset for the module. A low pulse will reset the module. A logic low for a minimum of 1 μ s is recommended to ensure a complete reset. This pin is pulled high internally.
8	Tri-State	Tri-State control for all outputs. 1 = Hi-Z condition, 0 = Normal operation. Pin is pulled low internally.
9	Hold Over Good	Indicates that the module has acquired enough data to provide an average Hold Over value.
10	Mode Alarm	Alarm indicator output. 1 = Alarm condition, 0 = Normal operation.
11	CNTL A	Mode control input. Pin is pulled low internally.
12	CNTL B	Mode control input. Pin is pulled low internally.
13	RFL	Reference frequency limit alarm for the phase locked loop. 1= Unit is \pm 15 ppm from Free Run freq.
14	GND	Ground
15	Sync_Out	System clock output
16	Future Use	Reserved for future use. Do not assert this pin
17	GND	Ground
18	Clock_Out	An independent, Stratum 3 clock output with the required \pm 4.6 ppm accuracy. May be used as general purpose clock
19	Future Use	Reserved for future use. Do not assert this pin
20	GND	Ground
21	External Reference 2	External reference #2 input
22	GND	Ground
23	External Reference 1	External reference #1 input
24	+5 V _{DC}	+5 Volt DC supply

Control Inputs

Table 6

CNTL B	CTNL A	Mode Selected
0	0	Free Run
0	1	Reference 1
1	0	Reference 2
1	1	Hold Over

Status Outputs

Table 7

Status 1	Status 0	Mode
0	0	Free Run
0	1	Reference 1
1	0	Reference 2
1	1	Hold Over

Pin Assignment

Figure 1

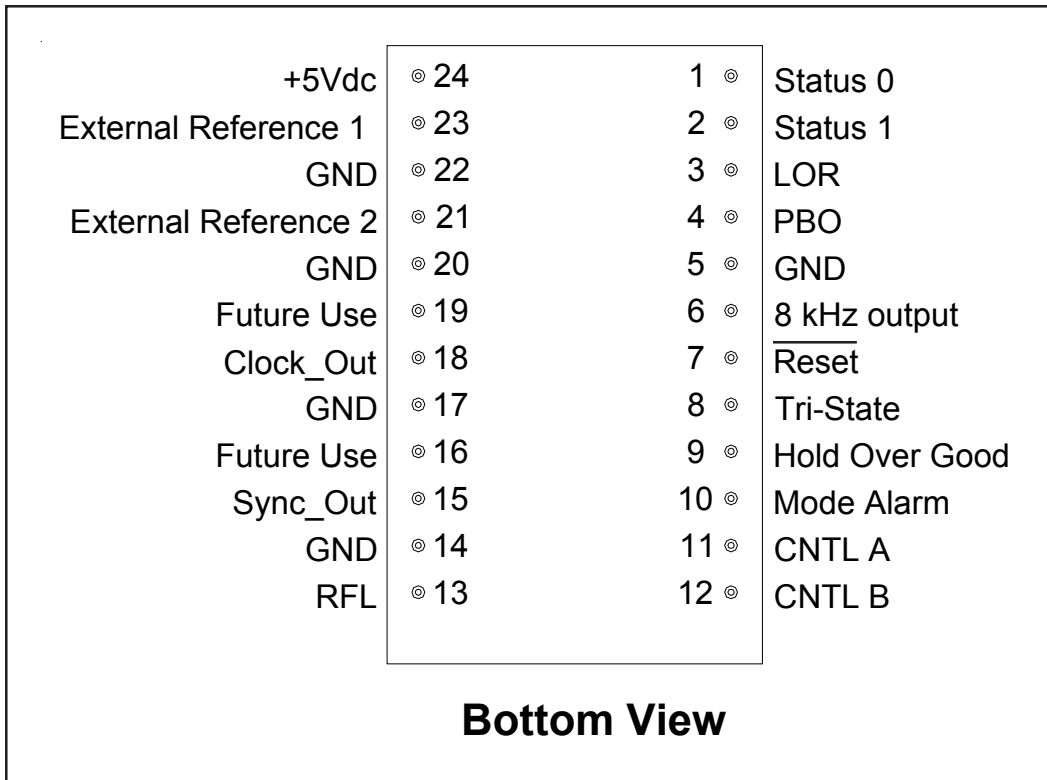

Typical Application Setup

Figure 2

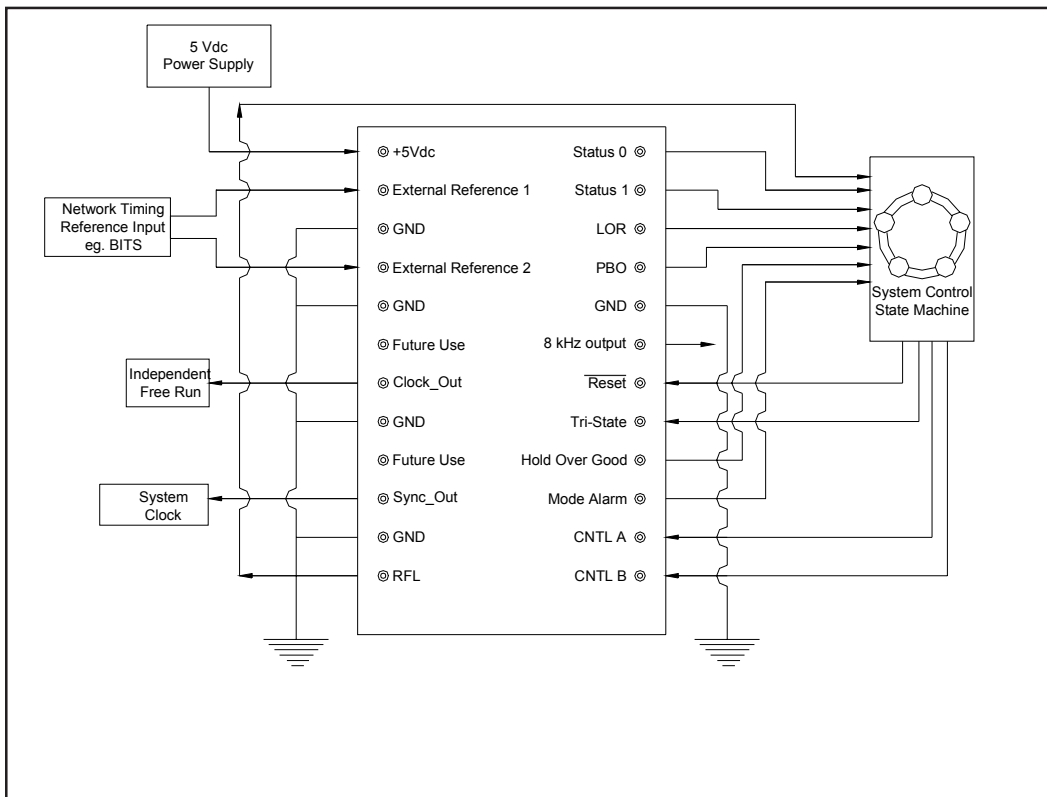

Functional Truth Table

Table 8

CNTLB	CNTLA	Mode	Status1	Status0	Alarm	RFL	LOR	PBO	Condition
0	0	Free Run	0	0	1	0	0	0	
0	0	Free Run	0	0	1	1	0	0	
0	1	Reference #1	0	1	0	0	0	0	Normal Operation
0	1	Reference #1	0	1	1	0	0	0	Unit is in Fast Acquire mode
0	1	Reference #1	0	1	0	1	0	0	Output freq. is 15 ppm or more from Free Run mode freq.
0	1	Reference #1	0	1	0	0	1	0	Selected reference signal is not detected and unit is in pseudo-Hold Over*
0	1	Reference #1	0	1	0	0	0	1	Phase build-out is occurring on selected reference
0	1	Reference #1	0	1	1	0	0	1	Phase build-out is occurring and has continuously occurred for at least 0.4 seconds and the unit is in pseudo-Hold Over*
1	0	Reference #2	1	0	0	0	0	0	Normal Operation
1	0	Reference #2	1	0	1	0	0	0	Unit is in Fast Acquire mode
1	0	Reference #2	1	0	0	1	0	0	Output freq. is 15 ppm or more from Free Run mode freq.
1	0	Reference #2	1	0	0	0	1	0	Selected reference signal is not detected and unit is in pseudo-Hold Over*
1	0	Reference #2	1	0	0	0	0	1	Phase build-out is occurring on selected reference
1	0	Reference #2	1	0	1	0	0	1	Phase build-out is occurring and has continuously occurred for at least 0.4 seconds and the unit is in pseudo-Hold Over*
1	1	Hold Over	1	1	1	0	0	0	
1	1	Hold Over	1	1	1	1	0	0	

*Pseudo-Hold Over is a condition when the module is no longer tracking a reference and is holding the last output that was sent to the Sync_Out pin. Variations in the output frequency are due only to the drift of the OCXO.

Functional Block Diagram

Figure 3

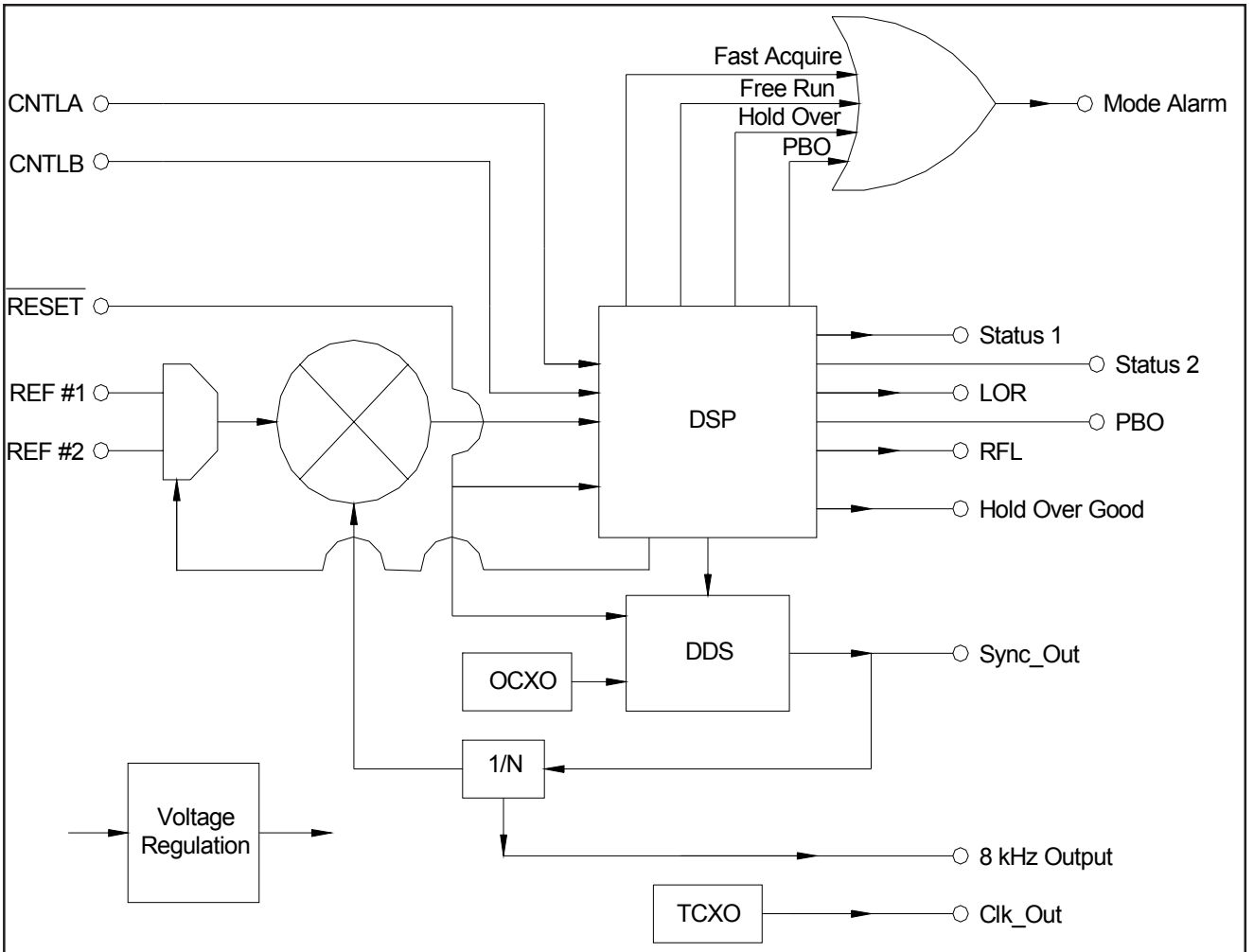

3E Wander Generation TDEV

Figure 4

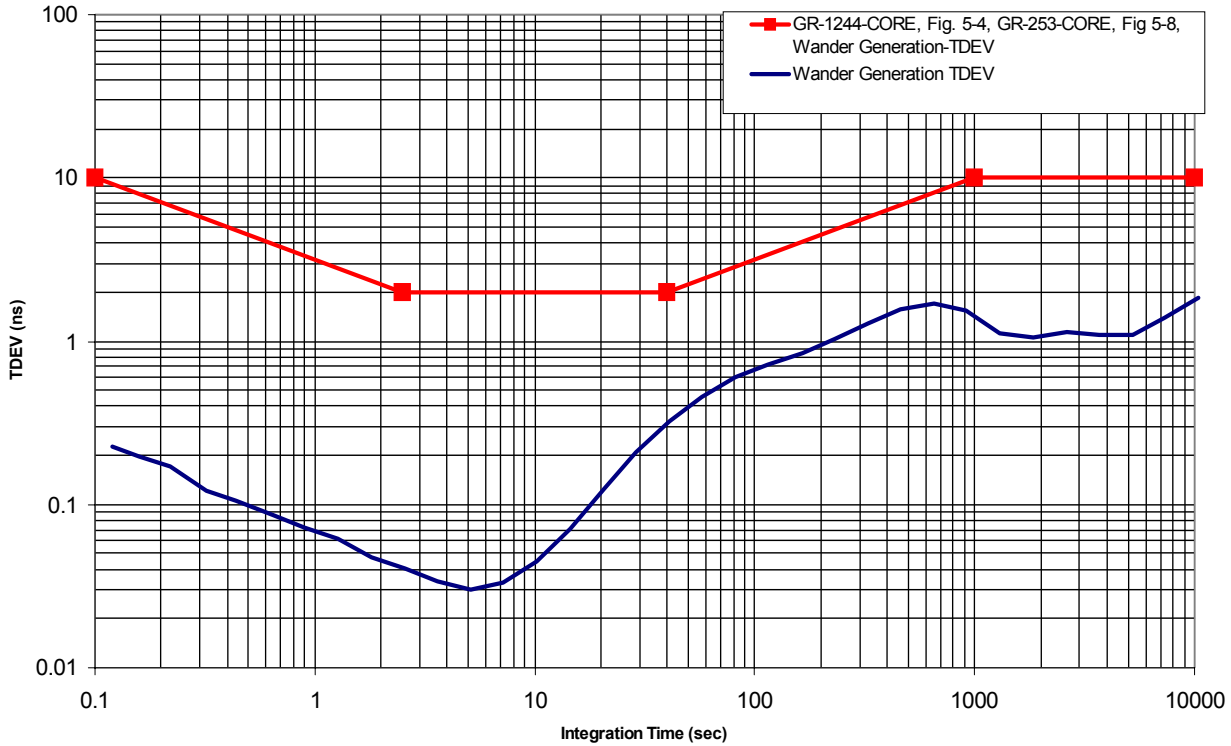

3E Wander Generation MTIE

Figure 5

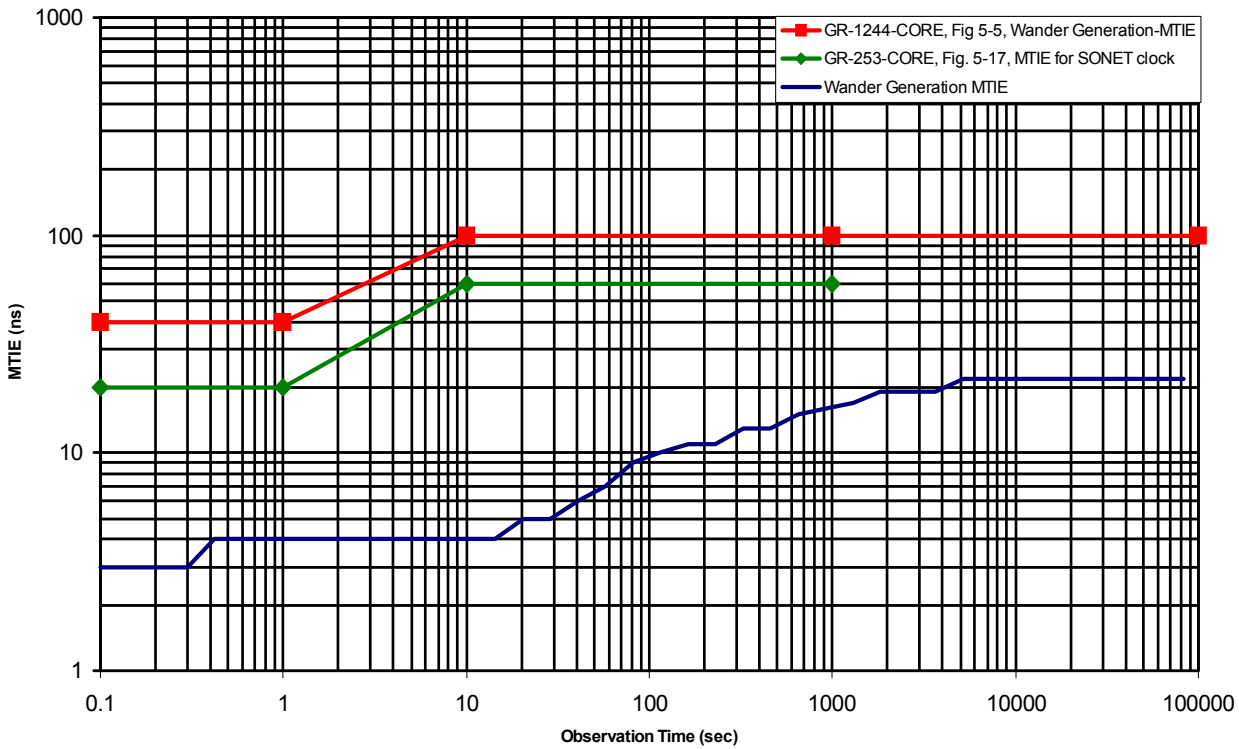

3E Wander Transfer TDEV

Figure 6

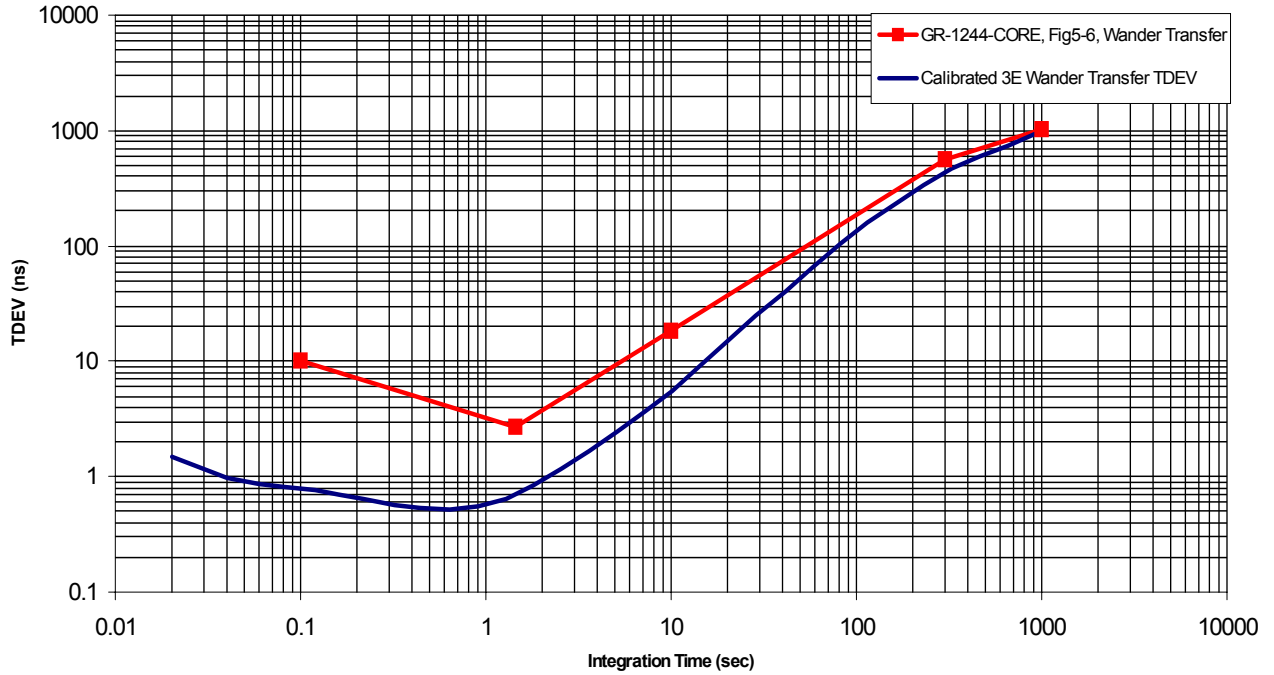

3E MTIE During Reference Rearrangement

Figure 7

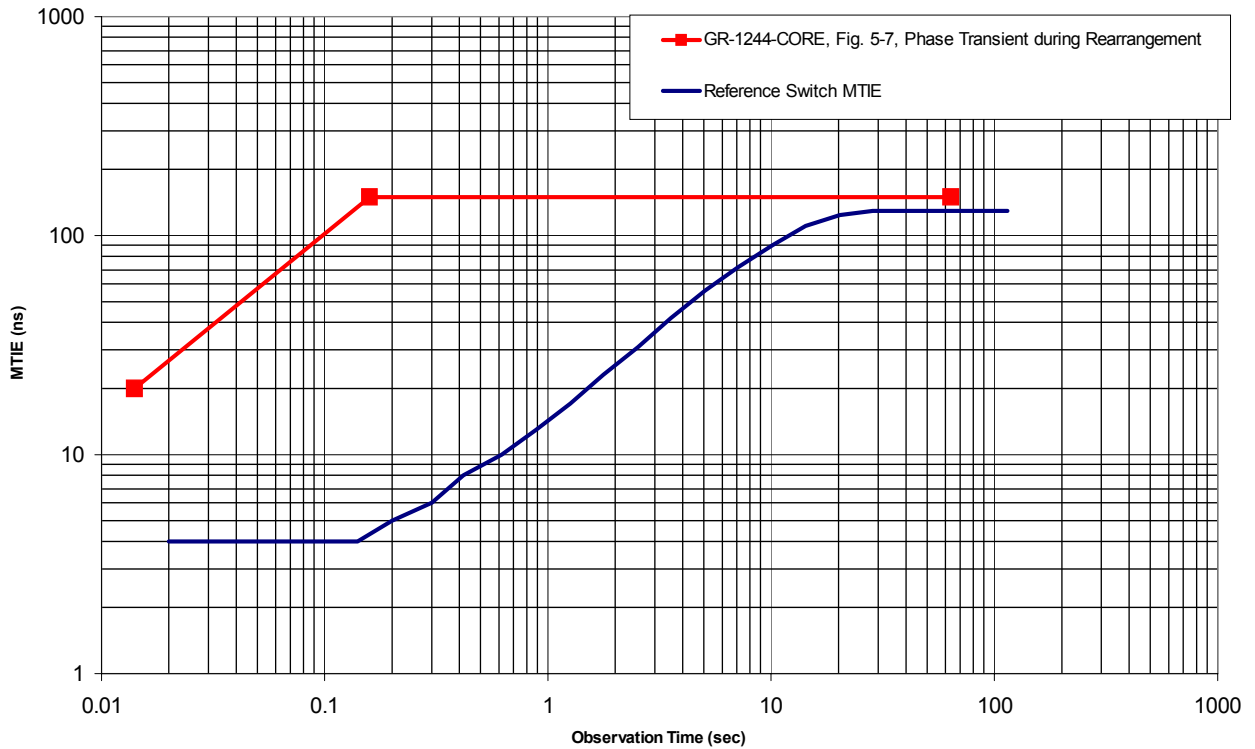

3E Entry into Hold Over MTIE

Figure 8

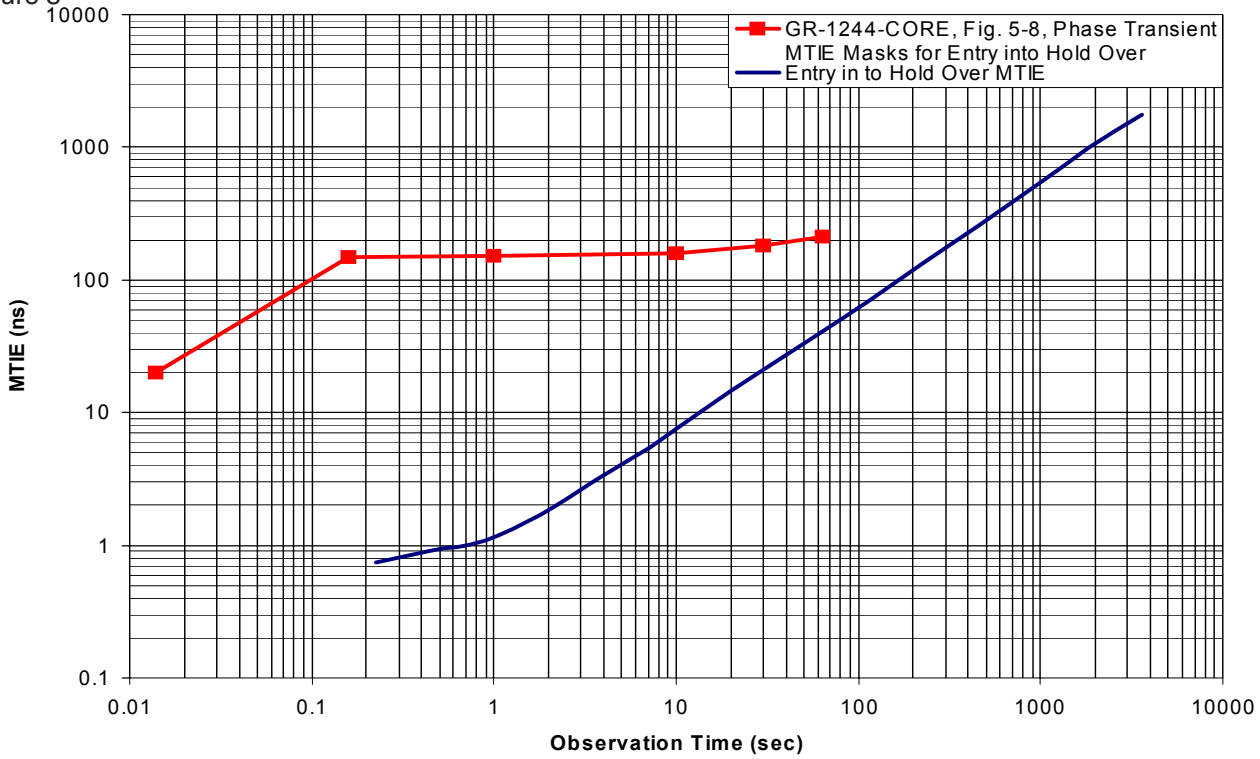

3E 1 μ s Phase Transient MTIE

Figure 9

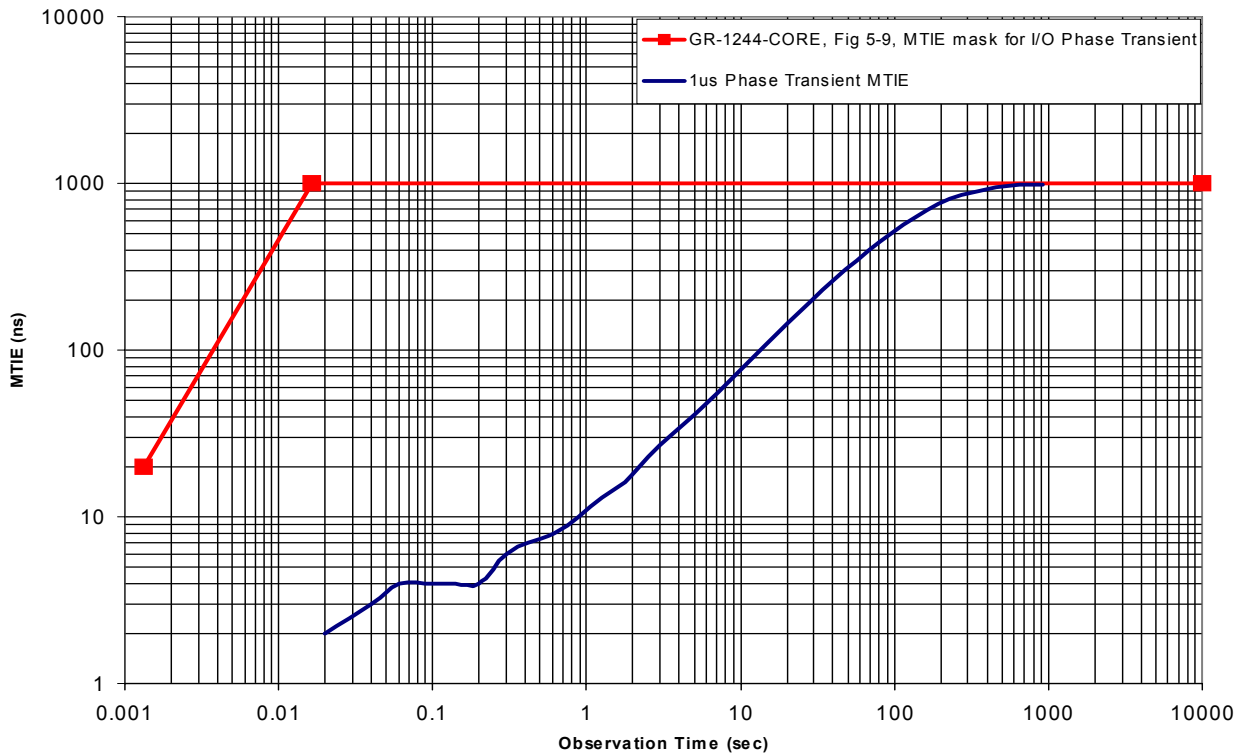

3E Jitter Attenuation

Figure 10

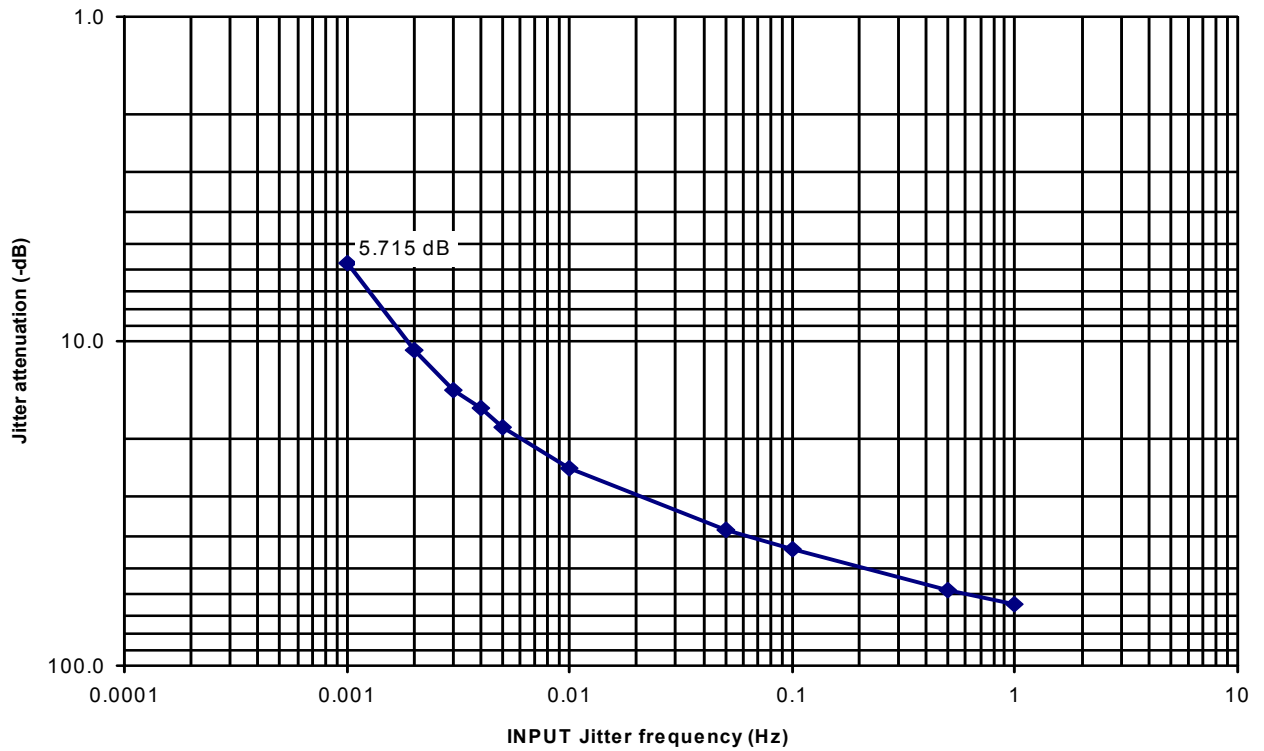

Hold Over Stability over Temperature

Figure 11

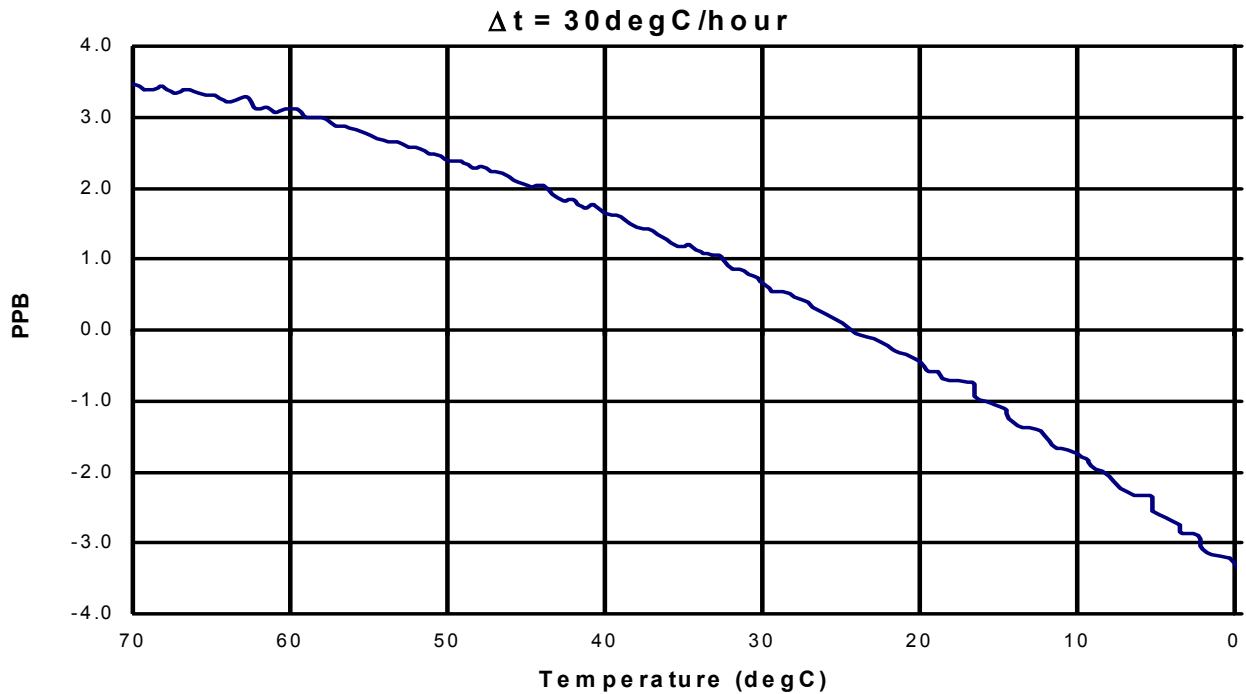

Typical Current Consumption Over Temperature

Figure 12

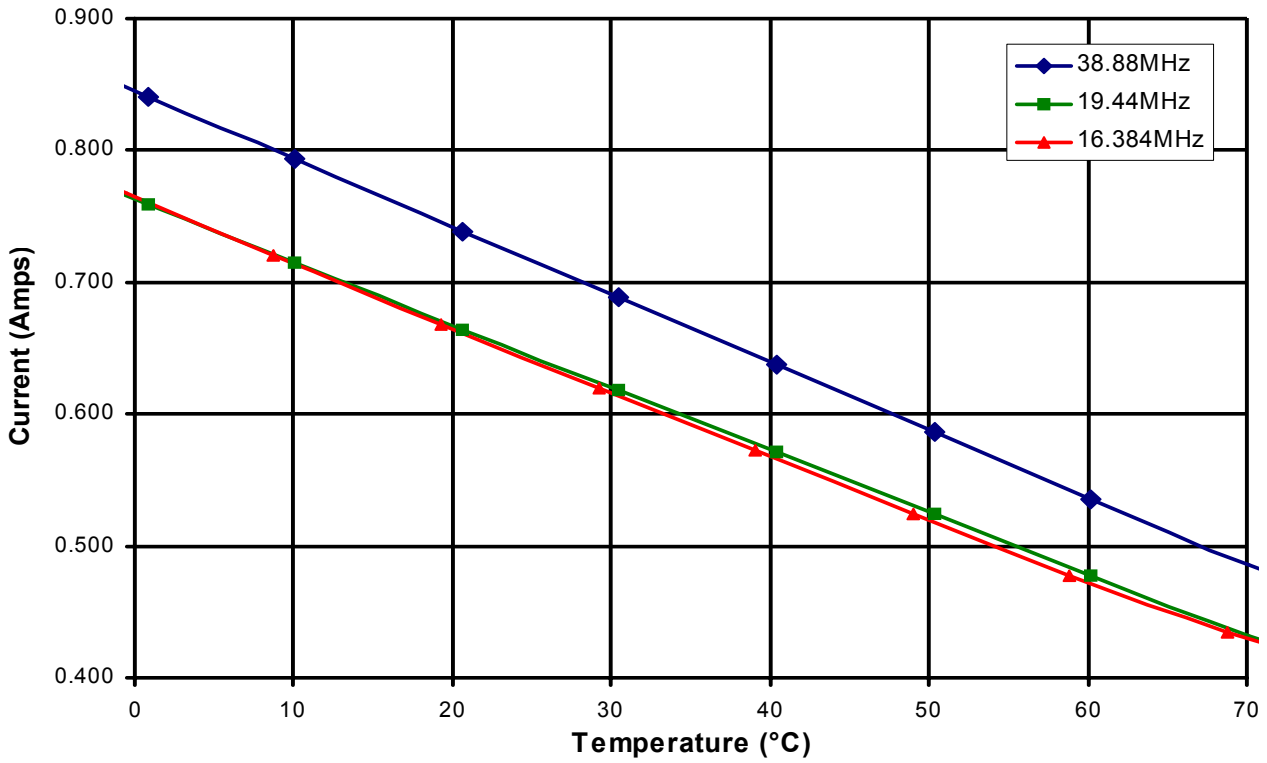

3E Typical Phase Build Out MTIE

Figure 13

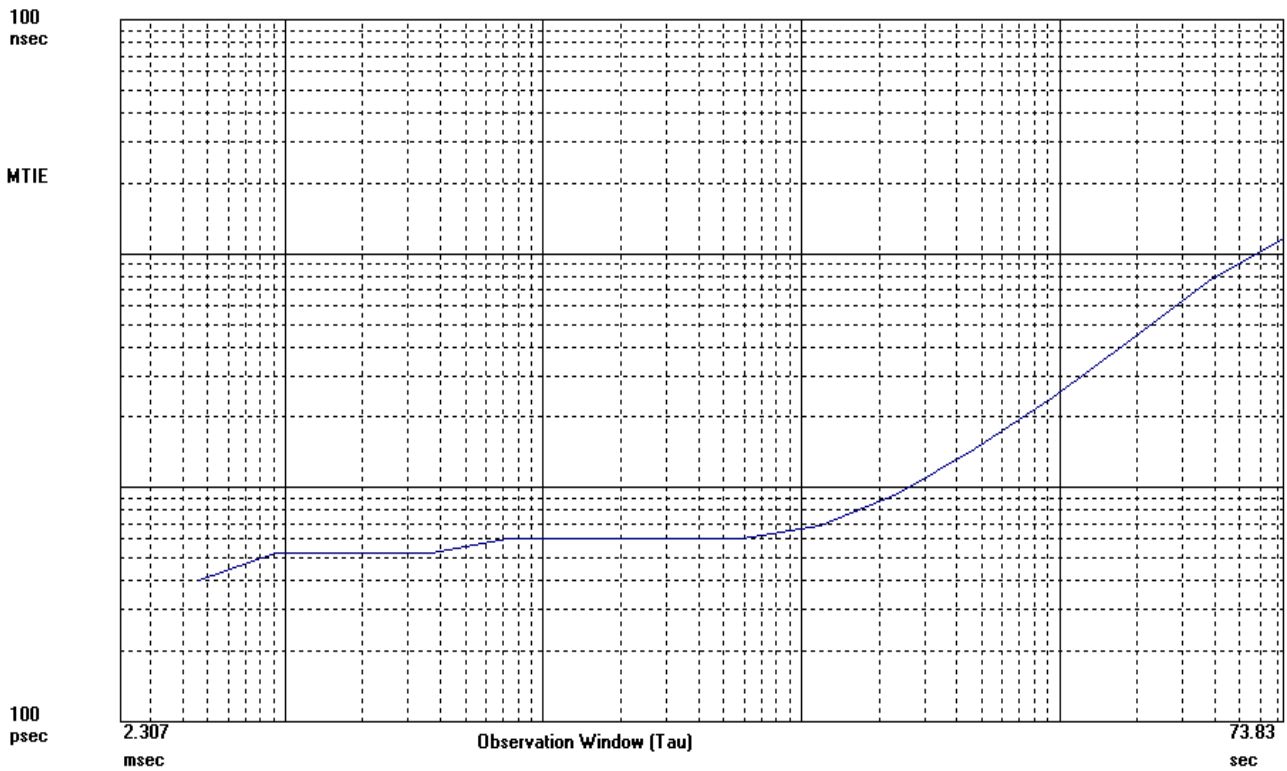

3E Phase Build Out ≥ 34 ppm Frequency Change

Figure 14

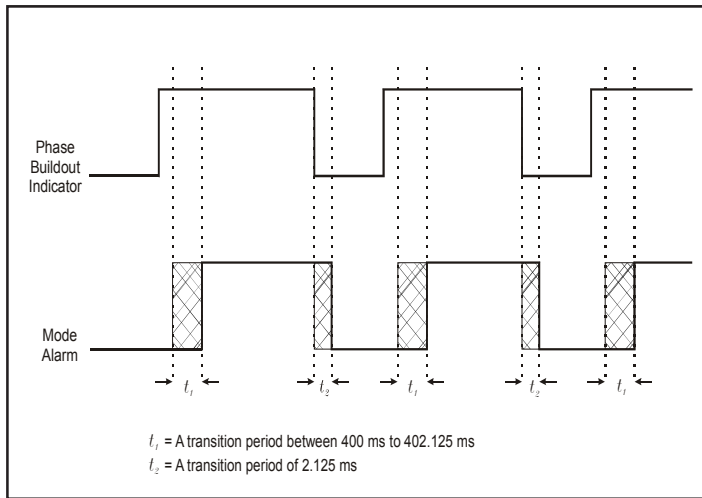

Mode Switch Timing

Figure 15

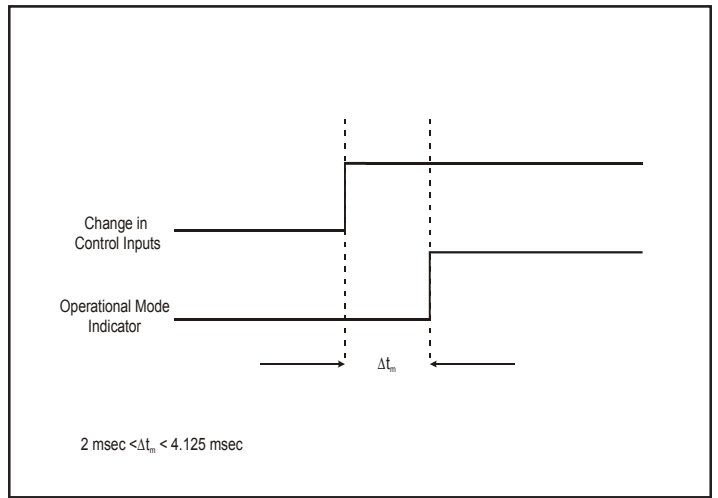

Loss of Reference Timing

Figure 16

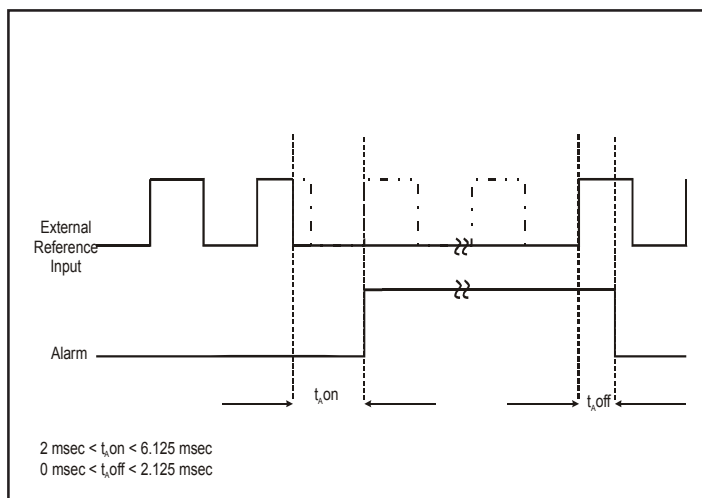

RFL Alarm Timing

Figure 17

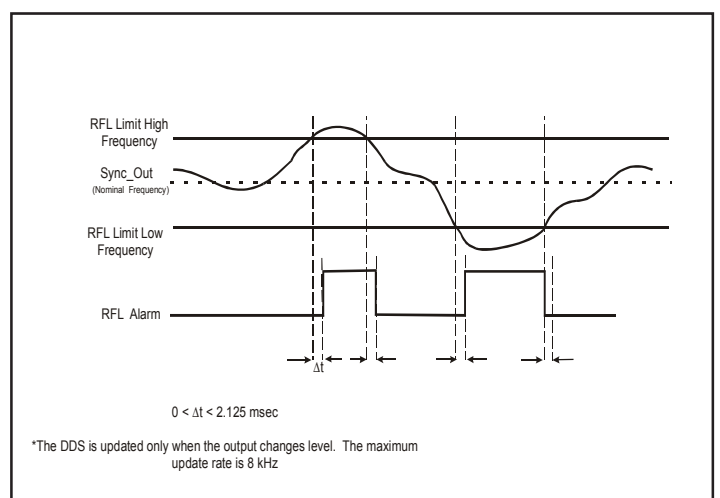

Hold Over Good Timing

Figure 18

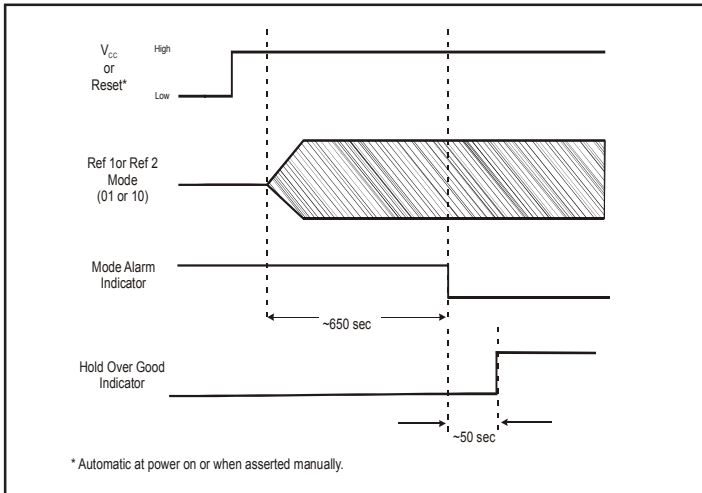

Mounting Clearance Dimensions

Figure 19

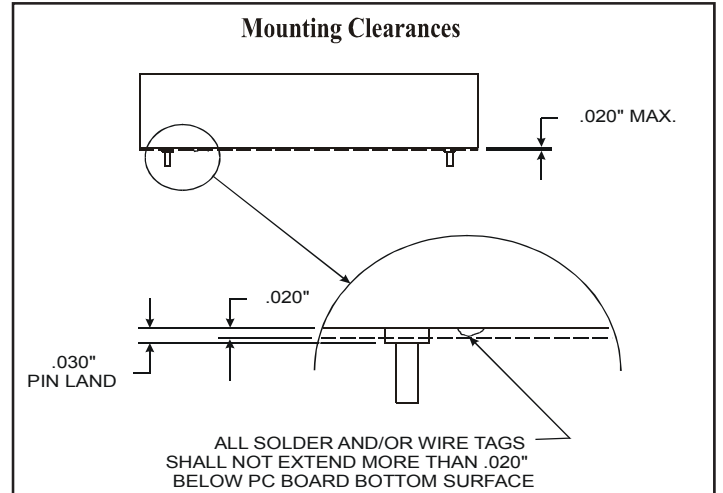

Package Dimensions

Figure 20

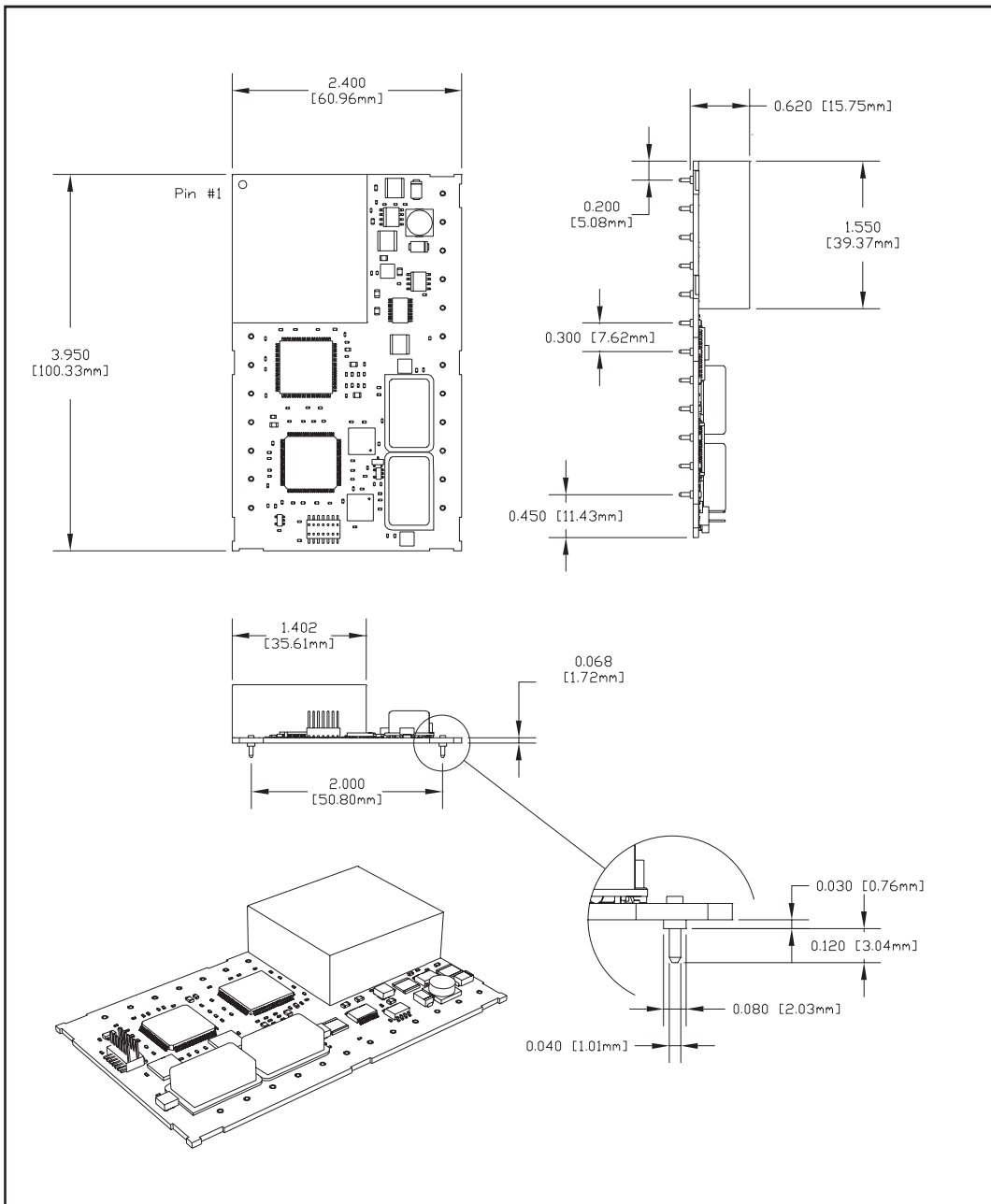



2111 Comprehensive Drive
Aurora, Illinois 60505
Phone: 630-851-4722
Fax: 630-851-5040
www.conwin.com

Revision #	Revision Date	Notes
P00	6/29/00	Preliminary informational release
P01	8/28/00	Included additional frequencies
P02	10/16/00	Changed format
P03	6/6/01	Changed to reflect new enhancements
P04	9/18/01	Added 5V tolerant note
P05	3/6/02	Changed mech. height to 0.620
P06	5/20/02	Updated Fig.9