

1.00mm (0.039") PITCH CONNECTOR

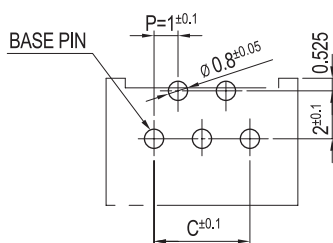

FPC/FFC Connector
Housing

FCZ100E-RSK Series
DIP, NON-ZIF(Top-Contact)
Right Angle

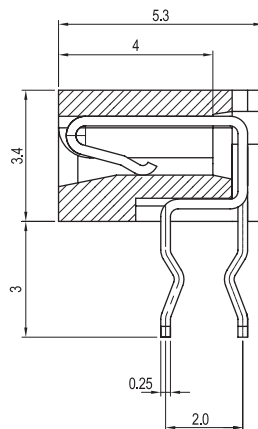
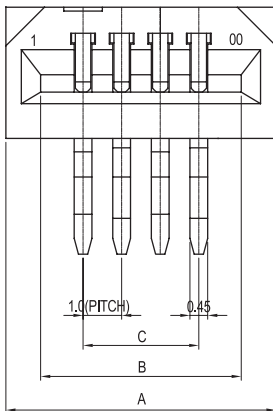
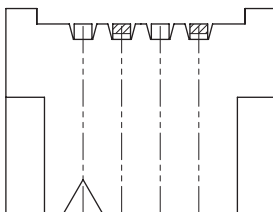
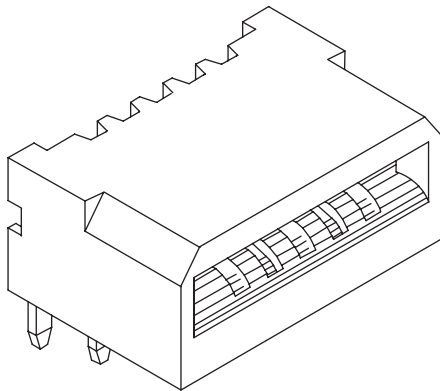

P.C.B. LAY-OUT(A-TYPE)

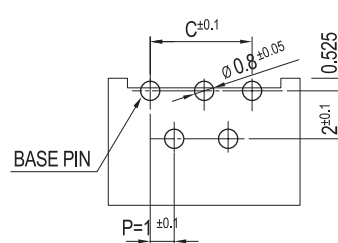

P.C.B. LAY-OUT(B-TYPE)

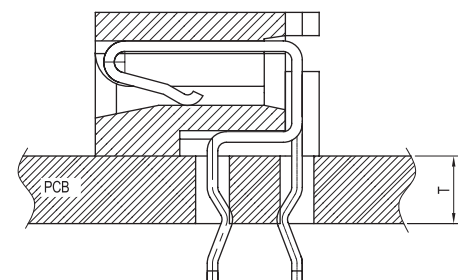

PCB ASS'Y

PARTS NO.

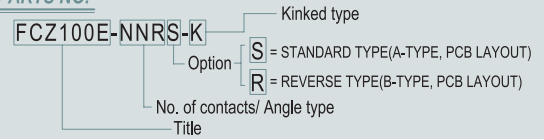

Material

I/NO	DESCRIPTION	TITLE	MATERIAL
1	HOUSING	FCZ100E-NNRS-K	PBT, UL 94V Grade
2	TERMINAL		Phosphor Bronze & Tin plated

Available Pin

PARTS NO.	A	B	C
FCZ100E-04RS-K	7.0	5.0	3.0
FCZ100E-05RS-K	8.0	6.0	4.0
FCZ100E-06RS-K	9.0	7.0	5.0
FCZ100E-07RS-K	10.0	8.0	6.0
FCZ100E-08RS-K	11.0	9.0	7.0
FCZ100E-09RS-K	12.0	10.0	8.0
FCZ100E-10RS-K	13.0	11.0	9.0
FCZ100E-11RS-K	14.0	12.0	10.0
FCZ100E-12RS-K	15.0	13.0	11.0
FCZ100E-13RS-K	16.0	14.0	12.0
FCZ100E-14RS-K	17.0	15.0	13.0
FCZ100E-15RS-K	18.0	16.0	14.0
FCZ100E-16RS-K	19.0	17.0	15.0
FCZ100E-17RS-K	20.0	18.0	16.0
FCZ100E-18RS-K	21.0	19.0	17.0
FCZ100E-19RS-K	22.0	20.0	18.0
FCZ100E-20RS-K	23.0	21.0	19.0
FCZ100E-21RS-K	24.0	22.0	20.0
FCZ100E-22RS-K	25.0	23.0	21.0
FCZ100E-23RS-K	26.0	24.0	22.0
FCZ100E-24RS-K	27.0	25.0	23.0
FCZ100E-25RS-K	28.0	26.0	24.0
FCZ100E-26RS-K	29.0	27.0	25.0
FCZ100E-27RS-K	30.0	28.0	26.0
FCZ100E-28RS-K	31.0	29.0	27.0
FCZ100E-29RS-K	32.0	30.0	28.0
FCZ100E-30RS-K	33.0	31.0	29.0
FCZ100E-32RS-K	35.0	33.0	31.0

Specification

ITEM	SPEC
Voltage Rating	AC/DC 50V
Current Rating	AC/DC 0.5A
Operating Temperature	-25°C ~ +85°C
Contact Resistance	30mΩ MAX
Withstanding Voltage	AC500V/1min
Insulation Resistance	100MΩ MIN
Applicable Wire	-
Applicable P.C.B	1.2 ~ 1.6mm
Applicable FPC/FFC	0.30±0.05mm
Solder Height	-
Crimp Tensile Strength	-
UL FILE NO	-