

FEATURES

- Complete rate gyroscope on a single chip
- Z-axis (yaw-rate) response
- High vibration rejection over wide frequency
- 2000 g powered shock survivability
- Self-test on digital command
- Temperature sensor output
- Precision voltage reference output
- Absolute rate output for precision applications
- 5 V single-supply operation
- Ultra small and light (< 0.15 cc, < 0.5 gram)

APPLICATIONS

- GPS navigation systems
- Image stabilization
- Inertial measurement units
- Platform stabilization

GENERAL DESCRIPTION

The ADXRS401 is a functionally complete and low cost angular rate sensor (gyroscope), integrated with all of the required electronics on one chip. It is manufactured using Analog Devices' surface-micromachining technique, the same high volume BIMOS process used for high reliability automotive airbag accelerometers. It is available in a 7 mm × 7 mm × 3 mm BGA surface-mount package.

The output signal, RATEOUT (1B, 2A), is a voltage proportional to angular rate about the axis normal to the top surface of the package (see Figure 2). A single external resistor can be used to lower the scale factor. An external capacitor is used to set the bandwidth. Other external capacitors are required for operation (see Figure 1).

A precision reference and a temperature output are also provided for compensation techniques. Two digital self-test inputs electromechanically excite the sensor to test proper operation of both sensors and the signal conditioning circuits.

FUNCTIONAL BLOCK DIAGRAM

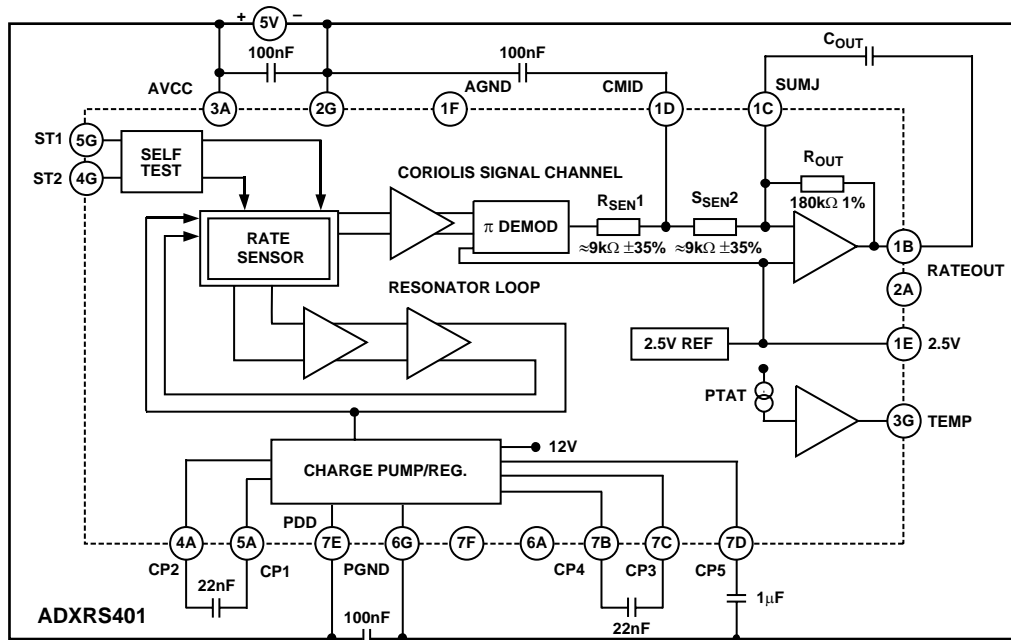

Figure 1.

Rev. 0

Information furnished by Analog Devices is believed to be accurate and reliable. However, no responsibility is assumed by Analog Devices for its use, nor for any infringements of patents or other rights of third parties that may result from its use. Specifications subject to change without notice. No license is granted by implication or otherwise under any patent or patent rights of Analog Devices. Trademarks and registered trademarks are the property of their respective owners.

TABLE OF CONTENTS

| | |
|--|----|
| Specifications..... | 3 |
| Absolute Maximum Ratings..... | 4 |
| Rate-Sensitive Axis | 4 |
| Pin Configuration and Function Descriptions..... | 5 |
| Typical Performance Characteristics | 6 |
| Theory of Operation | 8 |
| Supply and Common Considerations | 8 |
| Setting Bandwidth | 9 |
| Increasing Measurement Range | 9 |
| Temperature Output and Calibration | 9 |
| Use with a Supply-Ratiometric ADC..... | 10 |
| Null Adjust..... | 10 |
| Self-Test Function..... | 10 |
| Acceleration Sensitivity | 10 |
| Outline Dimensions | 12 |
| Ordering Guide..... | 12 |

REVISION HISTORY

7/04—Revision 0: Initial Version

SPECIFICATIONS

@T_A = 25°C, V_s = 5 V, bandwidth = 80 Hz (C_{OUT} = 0.01 μF), angular rate = 0°/s, ± 1 g, unless otherwise noted.

Table 1.

| Parameter | Conditions | Min | Typ | Max | Unit |
|---|---|-------|------|-----------------------|----------|
| SENSITIVITY | Top view clockwise rotation is positive output | | | | |
| Dynamic Range ¹ | Full-scale range, –40°C to +85°C | ±75 | | | °/s |
| Scale Factor | –40°C to +85°C | 12.75 | 15 | 17.25 | mV/°/s |
| Nonlinearity | Best fit straight line | | 0.1 | | % of FS |
| NULL | | | | | |
| Initial Null | | | 2.50 | | V |
| Turn-On Time | Power on to ± ½°/s of final | | 35 | | ms |
| Linear Acceleration Effect | Any axis | | 0.2 | | °/s/g |
| NOISE PERFORMANCE | | | | | |
| Rate Noise | @ 10 Hz bandwidth | | 3 | | mV (rms) |
| FREQUENCY RESPONSE | | | | | |
| 3 dB Bandwidth ² (User Selectable) | 22 nF as C _{OUT} (see Setting Bandwidth section) | | 40 | | Hz |
| Sensor Resonant Frequency | | | 14 | | kHz |
| SELF TEST | | | | | |
| ST1 RATEOUT Response ³ | ST1 pin from Logic 0 to 1 | | –800 | | mV |
| ST2 RATEOUT Response | ST2 pin from Logic 0 to 1 | | +800 | | mV |
| Logic 1 Input Voltage | Standard high logic level definition | 3.3 | | | V |
| Logic 0 Input Voltage | Standard low logic level definition | | | 1.7 | V |
| Input Impedance | To common | | 50 | | kΩ |
| TEMPERATURE SENSOR | | | | | |
| V _{OUT} at 298K | | | 2.50 | | V |
| Max Current Load on Pin | Source to common | | | 50 | μA |
| Scale Factor | Proportional to absolute temperature | | 8.4 | | mV/K |
| OUTPUT DRIVE CAPABILITY | | | | | |
| Output Voltage Swing | I _{OUT} = ±100 μA | 0.25 | | V _S – 0.25 | V |
| Capacitive Load Drive | | 1000 | | | pF |
| 2.5 V REFERENCE | | | | | |
| Voltage Value | | | 2.5 | | V |
| Load Drive to Ground | Source | | 200 | | μA |
| Load Regulation | 0 < I _{OUT} < 200 μA | | 5.0 | | mV/mA |
| POWER SUPPLY | | | | | |
| Operating Voltage Range | | 4.75 | 5.00 | 5.25 | V |
| Quiescent Supply Current | | | 6.0 | 8.0 | mA |
| TEMPERATURE RANGE | | | | | |
| Operating Temperature Range | | –40 | | +85 | °C |

¹ Dynamic range is the maximum full-scale measurement range possible, including output swing range, initial offset, sensitivity, offset drift, and sensitivity drift at 5 V supplies.

² Frequency at which response is 3 dB down from dc response with specified compensation capacitor value. Internal pole forming resistor is 180 kΩ. See the Setting Bandwidth section.

³ Self-test response varies with temperature. See the Self-Test Function section for details.

ABSOLUTE MAXIMUM RATINGS

Table 2.

| Parameter | Rating |
|---|------------------|
| Acceleration (Any Axis, Unpowered, 0.5 ms) | 2000 g |
| Acceleration (Any Axis, Powered, 0.5 ms) | 2000 g |
| +V _s | -0.3 V to +6.0 V |
| Output Short-Circuit Duration (Any Pin to Common) | Indefinite |
| Operating Temperature Range | -55°C to +125°C |
| Storage Temperature | -65°C to +150°C |

Stresses above those listed under the Absolute Maximum Ratings may cause permanent damage to the device. This is a stress rating only; functional operation of the device at these or any other conditions above those indicated in the operational section of this specification is not implied. Exposure to absolute maximum rating conditions for extended periods may affect device reliability.

Applications requiring more than 200 cycles to MIL-STD-883 Method 1010 Condition B (-55°C to +125°C) require underfill or other means to achieve this requirement.

Drops onto hard surfaces can cause shocks of greater than 2000 g and exceed the absolute maximum rating of the device. Care should be exercised in handling to avoid damage.

ESD CAUTION

ESD (electrostatic discharge) sensitive device. Electrostatic charges as high as 4000 V readily accumulate on the human body and test equipment and can discharge without detection. Although this product features proprietary ESD protection circuitry, permanent damage may occur on devices subjected to high energy electrostatic discharges. Therefore, proper ESD precautions are recommended to avoid performance degradation or loss of functionality.



RATE-SENSITIVE AXIS

This Z-axis rate-sensing device is also called a yaw-rate sensing device. It produces a positive-going output voltage for clockwise rotation about the axis normal to the package top (clockwise when looking down at the package lid).

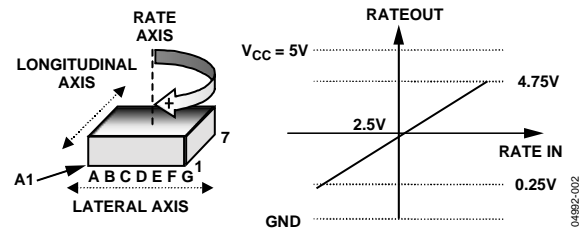

Figure 2. RATEOUT Signal Increases with Clockwise Rotation

PIN CONFIGURATION AND FUNCTION DESCRIPTIONS

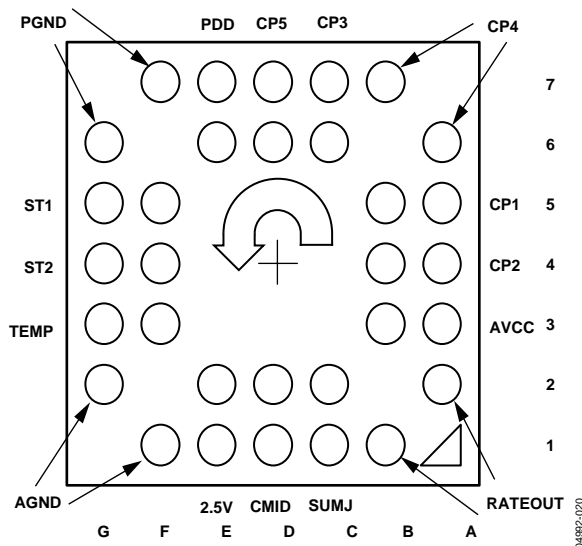

Figure 3. BGA-32 (Bottom View)

Table 3. Pin Function Descriptions

| Pin No. | Mnemonic | Description |
|---------|----------|--|
| 6D, 7D | CP5 | HV Filter Capacitor to Ground – 1 μ F 20 V minimum |
| 6A, 7B | CP4 | Charge Pump Capacitor – 22 nF |
| 6C, 7C | CP3 | Charge Pump Capacitor – 22 nF |
| 5A, 5B | CP1 | Charge Pump Capacitor – 22 nF |
| 4A, 4B | CP2 | Charge Pump Capacitor – 22 nF |
| 3A, 3B | AVCC | + Analog Supply |
| 1B, 2A | RATEOUT | Rate Signal Output |
| 1C, 2C | SUMJ | Output Amp Summing Junction |
| 1D, 2D | CMID | HF Filter Capacitor – 100 nF |
| 1E, 2E | V2.5 | 2.5 V Precision Reference |
| 1F, 2G | AGND | Analog Supply Return |
| 3F, 3G | TEMP | Temperature Voltage Output |
| 4F, 4G | ST2 | Self-Test for Sensor 2 |
| 5F, 5G | ST1 | Self-Test for Sensor 1 |
| 6G, 7F | PGND | Charge Pump Supply Return |
| 6E, 7E | PDD | + Charge Pump Supply |

TYPICAL PERFORMANCE CHARACTERISTICS

@ BW = 40 Hz, Typical Vibration Characteristics, 10 g Flat Band, 20 Hz to 2 kHz.

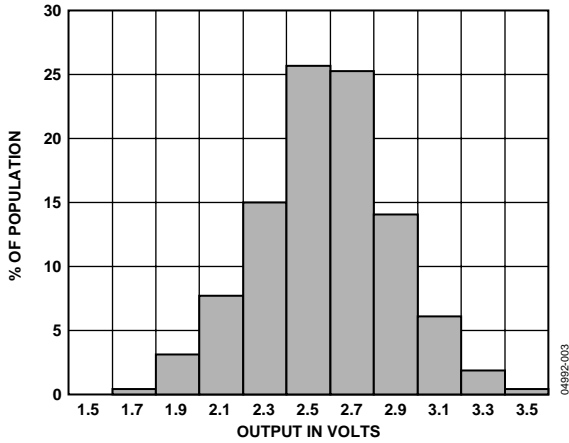

Figure 4. Initial Null Output

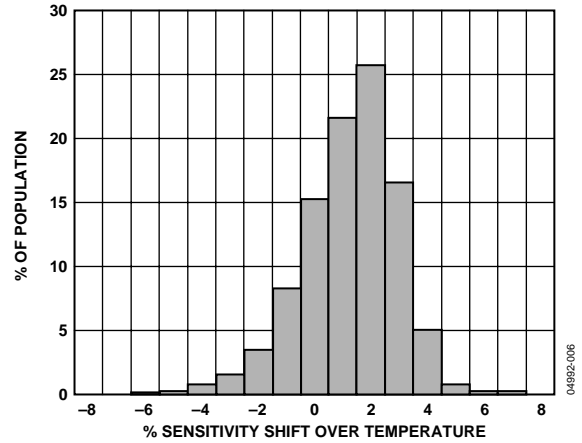

Figure 7. Sensitivity Change Over Temperature

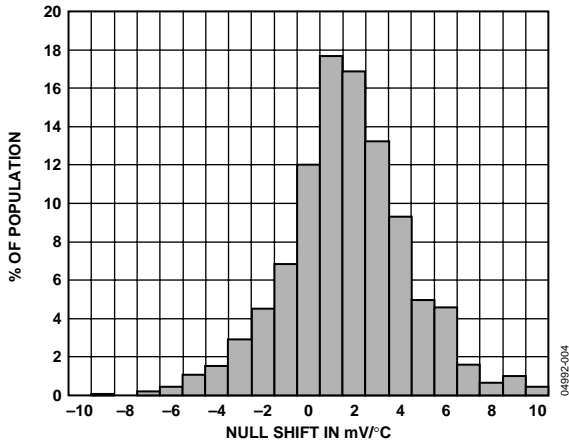

Figure 5. Null Tempco

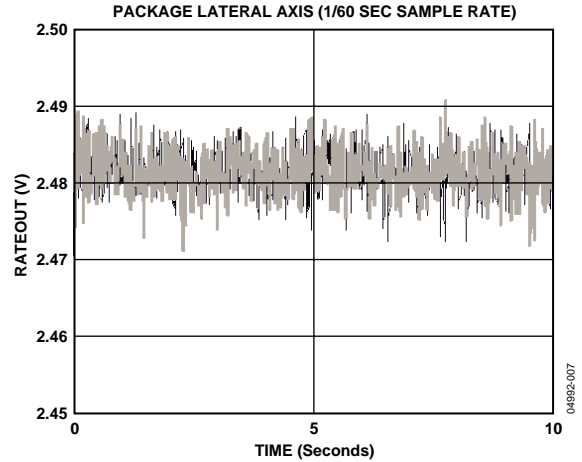

Figure 8. 10 g Random Vibration in Package-Lateral Axis Orientation

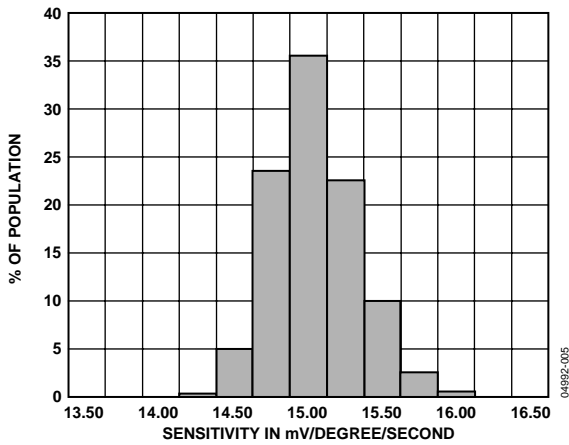

Figure 6. Initial Sensitivity

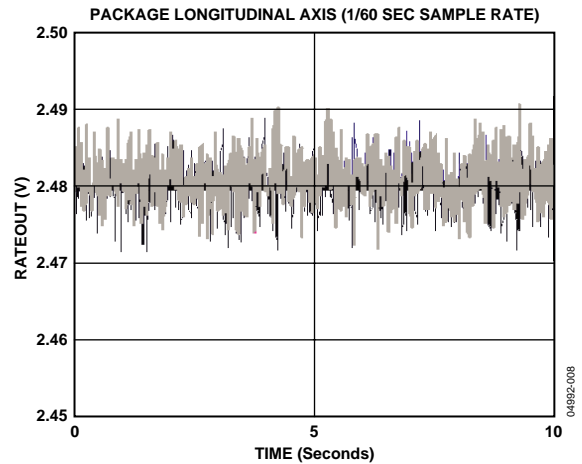

Figure 9. 10 g Random Vibration in Package-Longitudinal Axis Orientation

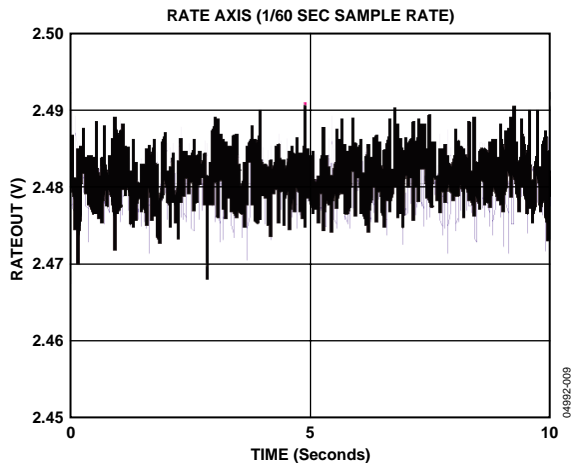

Figure 10. 10 g Random Vibration in Rate Axis Orientation

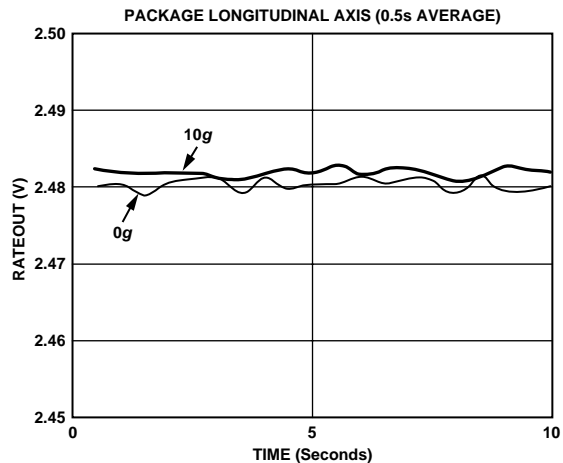

Figure 12. 10 g Random Vibration in Package-Longitudinal Axis Orientation

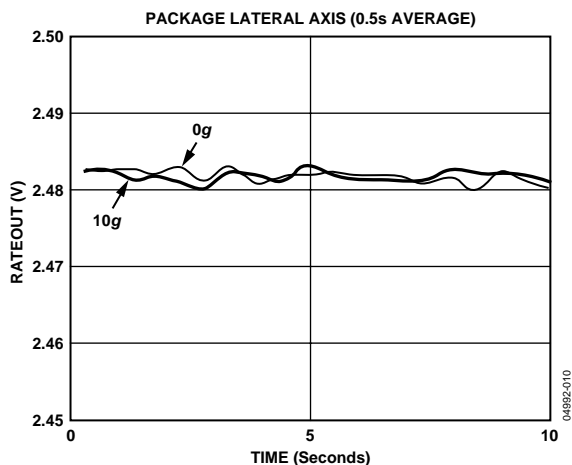

Figure 11. 10 g Random Vibration in Package-Lateral Axis Orientation

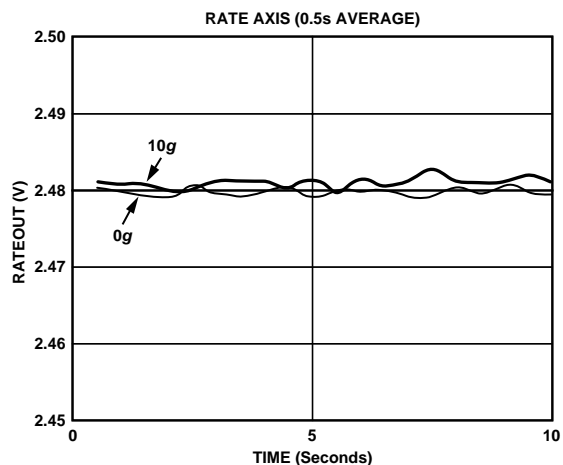

Figure 13. 10 g Random Vibration in Rate Axis Orientation

THEORY OF OPERATION

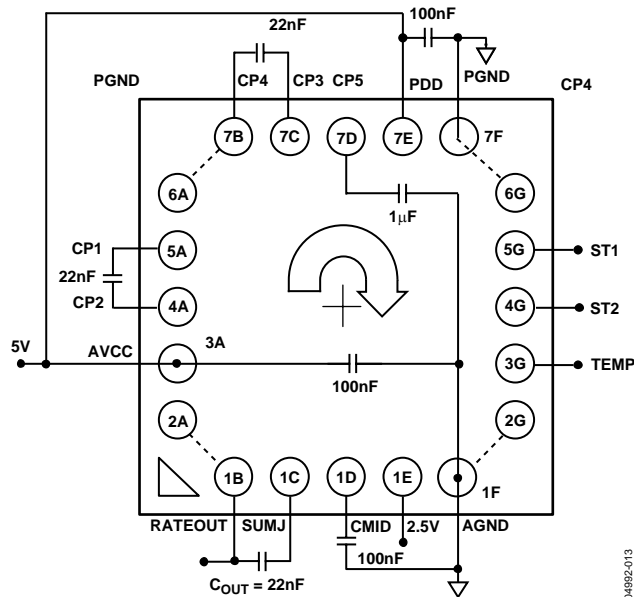

Figure 14. Example Application Circuit (Top View)

Note that inner rows/columns of pins have been omitted for clarity but should be connected in the application.

The ADXRS401 operates on the principle of a resonator gyro. Two polysilicon sensing structures each contain a dither frame, which is electrostatically driven to resonance. This produces the necessary velocity element to produce a Coriolis force during angular rate. At two of the outer extremes of each frame, orthogonal to the dither motion, are movable fingers that are placed between fixed pickoff fingers to form a capacitive pickoff structure that senses Coriolis motion.

The resulting signal is fed to a series of gain and demodulation stages that produce the electrical rate signal output. The dual-sensor design rejects external g-forces and vibration. Fabricating the sensor with the signal conditioning electronics preserves signal integrity in noisy environments.

The electrostatic resonator requires 14 V to 16 V for operation. Since only 5 V is typically available in most applications, a charge pump is included on-chip. If an external 14 V to 16 V supply is available, the two capacitors on CP1 to CP4 can be omitted and this supply can be connected to CP5 (Pin 7D) with a 1 µF decoupling capacitor.

After the demodulation stage there is a single-pole low-pass filter consisting of an internal 9 kΩ resistor (R_{SEN1}) and an external user-supplied capacitor (CMID). A CMID capacitor of 100 nF sets a 400 Hz low-pass pole $\pm 35\%$ and is used to limit high frequency artifacts before final amplification. A bandwidth limit capacitor, C_{OUT} , sets the pass bandwidth (see Setting Bandwidth section).

SUPPLY AND COMMON CONSIDERATIONS

Only power supplies used for supplying analog circuits are recommended for powering the ADXRS401. High frequency noise and transients associated with digital circuit supplies may have adverse affects on device operation. 1 µF shows the recommended connections for the ADXRS401 where both AVCC and PDD have a separate decoupling capacitor. These should be placed as close to their respective pins as possible before routing to the system analog supply. This will minimize the noise injected by the charge pump that uses the PDD supply.

It is also recommended to place the charge pump capacitors connected to the CP1 to CP4 pins as close to the part as possible. These capacitors are used to produce the on-chip high voltage supply switched at the dither frequency at approximately 14 kHz. Care should be taken to ensure that there is no more than 50 pF of stray capacitance between CP1 to CP4 and ground. Surface-mount chip capacitors are suitable as long as they are rated for over 15 V.

SETTING BANDWIDTH

External capacitors C_{MID} and C_{OUT} are used in combination with on-chip resistors to create two low-pass filters to limit the bandwidth of the ADXRS401's rate response. The -3 dB frequency set by R_{OUT} and C_{OUT} is:

$$f_{OUT} = 1/(2 \times \pi \times R_{OUT} \times C_{OUT})$$

This frequency can be well controlled since R_{OUT} has been trimmed during manufacturing to be $180 \text{ k}\Omega \pm 1\%$. Any external resistor applied between the RATEOUT (1B, 2A) and SUMJ (1C, 2C) pins will result in:

$$R_{OUT} = (180 \text{ k}\Omega \times R_{EXT}) / (180 \text{ k}\Omega + R_{EXT})$$

The -3 dB frequency is set by R_{SEN} (the parallel combination of R_{SEN1} and R_{SEN2}) at about $4.5 \text{ k}\Omega$ nominal. C_{MID} is less well controlled, because R_{SEN1} and R_{SEN2} have been used to trim the rate sensitivity during manufacturing and have a $\pm 35\%$ tolerance. Its primary purpose is to limit the high frequency demodulation artifacts from saturating the final amplifier stage. Thus, this pole of nominally 400 Hz @ $0.1 \mu\text{F}$ need not be precise. Lower frequency is preferable, but its variability usually requires it to be about 10 times greater (in order to preserve phase integrity) than the well-controlled output pole. In general, both -3 dB filter frequencies should be set as low as possible to reduce the amplitude of these high frequency artifacts, as well as to reduce the overall system noise.

INCREASING MEASUREMENT RANGE

To increase the full-scale measurement range of the ADXRS401, place an external resistor between the RATEOUT (1B, 2A) and SUMJ (1C, 2C) pins. This parallels the internal R_{OUT} resistor that is factory-trimmed to $180 \text{ k}\Omega$.

For example, a $330 \text{ k}\Omega$ external resistor gives approximately $10 \text{ mV}/^\circ\text{sec}$ sensitivity and a commensurate $\sim 50\%$ increase in the full-scale range. This is effective for up to a $4\times$ increase in the full-scale range. (The minimum value of the parallel resistor allowed is $45 \text{ k}\Omega$.) Beyond this amount of external sensitivity reduction, the internal circuitry headroom requirements prevent further increase in the linear full-scale output range.

The drawbacks of modifying the full-scale range are the additional output null drift (as much as $2^\circ/\text{sec}$ over temperature) and the readjustment of the initial null bias. See Null Adjust section and Application Note AN-625 for details.

TEMPERATURE OUTPUT AND CALIBRATION

It is common practice to temperature-calibrate gyros to improve their overall accuracy. The ADXRS401 has a temperature-proportional voltage output that provides input to such a calibration method. The voltage at TEMP (3F, 3G) is nominally 2.5 V at 27°C and has a PTAT (proportional to absolute temperature) characteristic of $8.4 \text{ mV}/^\circ\text{C}$. Note that the TEMP output circuitry is limited to $50 \mu\text{A}$ source current.

Limiting the bandwidth of the device reduces the flat-band noise during the calibration process, improving the measurement accuracy at each calibration point.

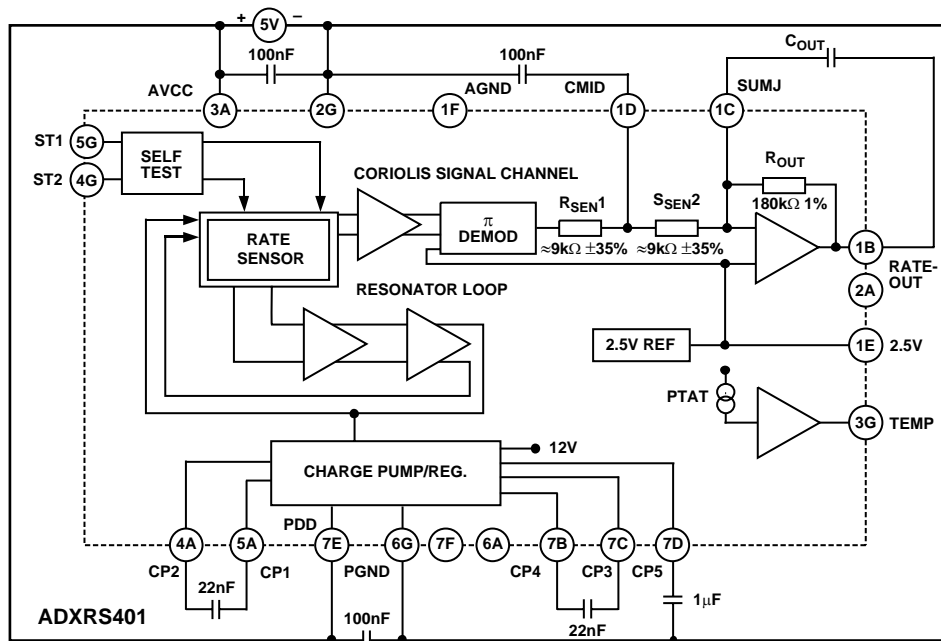

Figure 15. Block Diagram with External Components

ADXRS401

USE WITH A SUPPLY-RATIOMETRIC ADC

The ADXRS401's RATEOUT signal is nonratiometric (that is, neither the null voltage nor the rate sensitivity is proportional to the supply). Rather, they are nominally constant for dc supply changes within the 4.75 V to 5.25 V operating range. If the ADXRS401 is used with a supply-ratiometric ADC, the ADXRS401's 2.5 V output can be converted and used to make corrections in software for the supply variations.

NULL ADJUST

Null adjustment is possible by injecting a suitable current to SUMJ (1C, 2C). Simply add a suitable resistor to either the ground or the positive supply. The nominal 2.5 V null is for a symmetrical swing range at RATEOUT (1B, 2A). In some applications, a nonsymmetrical output swing may be suitable. If a resistor is connected to the positive supply, supply disturbances may reflect some null instability. Avoid digital supply noise, particularly in this case (see the Supply and Common Considerations section).

The resistor value to use is approximately:

$$R_{NULL} = (2.5 \times 180,000) / (V_{NULL0} - V_{NULL1})$$

V_{NULL0} is the unadjusted zero rate output, and V_{NULL1} is the target null value. If the initial value is below the desired value, the resistor should terminate on common or ground. If it is above the desired value, the resistor should terminate on the 5 V supply. Values typically are in the 1 M Ω to 5 M Ω range.

If an external resistor is used across RATEOUT and SUMJ, the parallel equivalent value is substituted into the above equation. Note that the resistor value is an estimate since it assumes $V_{CC} = 5.0$ V and $V_{SUMJ} = 2.5$ V.

SELF-TEST FUNCTION

The ADXRS401 includes a self-test feature that stimulates each of the sensing structures and associated electronics in the same manner, as if subjected to angular rate. It is activated by standard logic high levels applied to inputs ST1 (5F, 5G), ST2 (4F, 4G), or both. ST1 causes the voltage at RATEOUT to change about -0.800 V, and ST2 causes an opposite $+0.800$ V.

Activating both ST1 and ST2 simultaneously is not damaging. Because ST1 and ST2 are not necessarily closely matched, actuating both simultaneously may result in an apparent null bias shift.

ACCELERATION SENSITIVITY

The sign convention used is that lateral acceleration is positive in the direction from Pin Column A to Pin Column G of the package. That is, a device has positive sensitivity if its voltage output increases when the row of Pins 2A to 6A are tipped under the row 2G to 6G in the Earth's gravity.

There are two effects of concern: shifts in the static null and induced null noise. Scale factor is not significantly affected until acceleration reaches several hundred meters per second squared.

Vibration rectification for frequencies up to 20 kHz is of the order of $0.00002(^{\circ}/s)/(m/s^2)$ in the primary axis and $0.0003(^{\circ}/s)/(m/s^2)^2$ for acceleration applied along a diagonal of the lid. It is not significantly dependent on frequency, and has been verified up to 300 m/s² rms.

Linear vibration spectral density near the 14 kHz sensor resonance translates into output noise. In order to have a significant effect, the vibration must be within the angular rate bandwidth (typically ± 40 Hz of the resonance), so it takes considerable high frequency vibration to have any effect.

Away from the 14 kHz resonance, the effect is not discernible, except for vibration frequencies within the angular rate pass band. The in-band effect can be seen in Figure 17. This is the result of the static g-sensitivity. The specimen used for Figure 17 had a g-sensitivity of 0.15 %/s/g and its total in-band noise degraded from 3 mV rms to 5 mV rms for the specified vibration. The effect of broadband vibration up is shown in Figure 18 and Figure 19.

The output noise of the part falls away in accordance with the output low-pass filter and does not contain any spikes greater than 1% of the low frequency noise. A typical noise spectrum is shown in Figure 16.

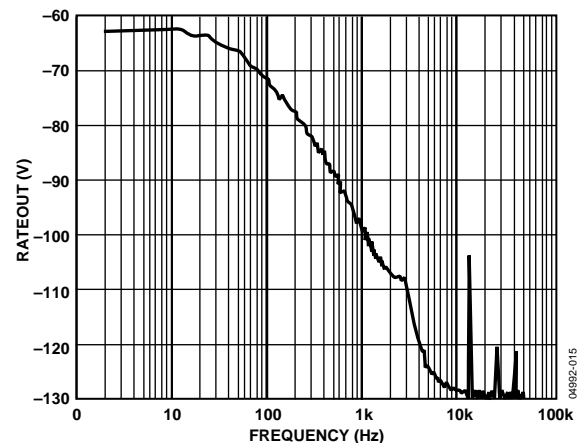

Figure 16. Noise Spectral Density at RATEOUT – BW = 4Hz

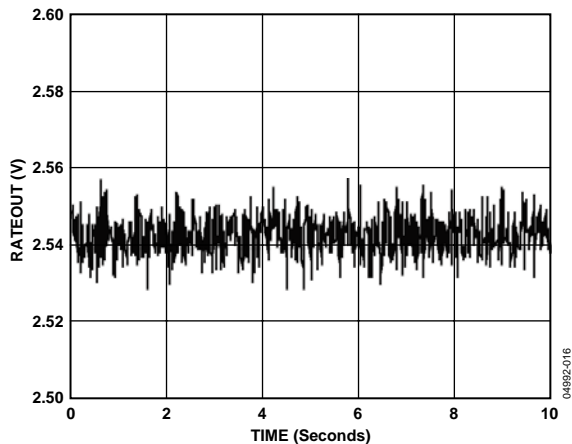

Figure 17. Random Vibration (Lateral) 2 Hz to 40 Hz 3.2 g rms

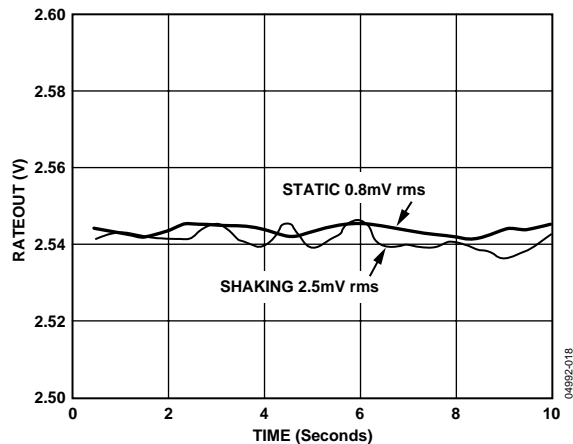

Figure 19. Random Vibration (Lateral) 10 kHz to 20 kHz at 0.01 g/√Hz with 60 Hz Sampling and 0.5 Sec Averaging

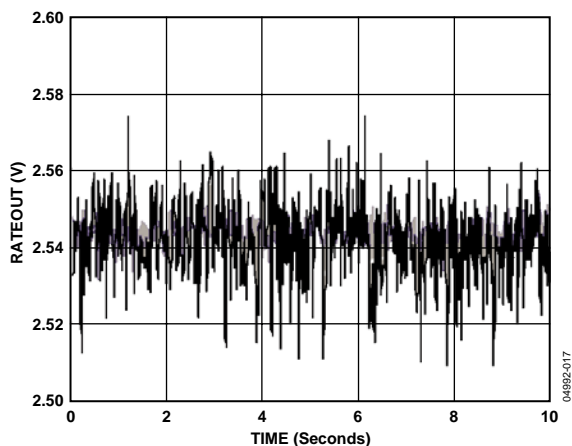

Figure 18. Random Vibration (Lateral) 10 kHz to 20 kHz at 0.01 g/√Hz with 60 Hz Sampling and 0.5 Sec Averaging

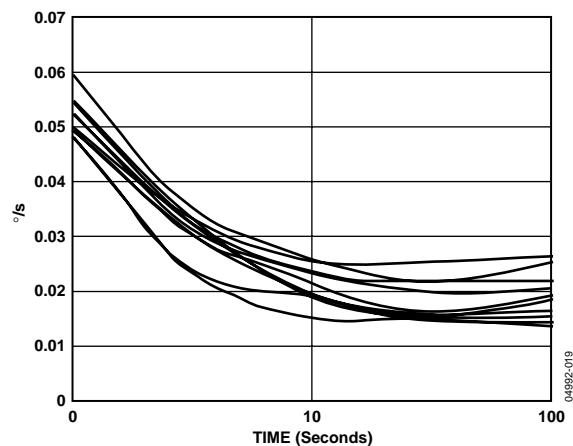

Figure 20. Root Allen Variance vs. Averaging Time

OUTLINE DIMENSIONS

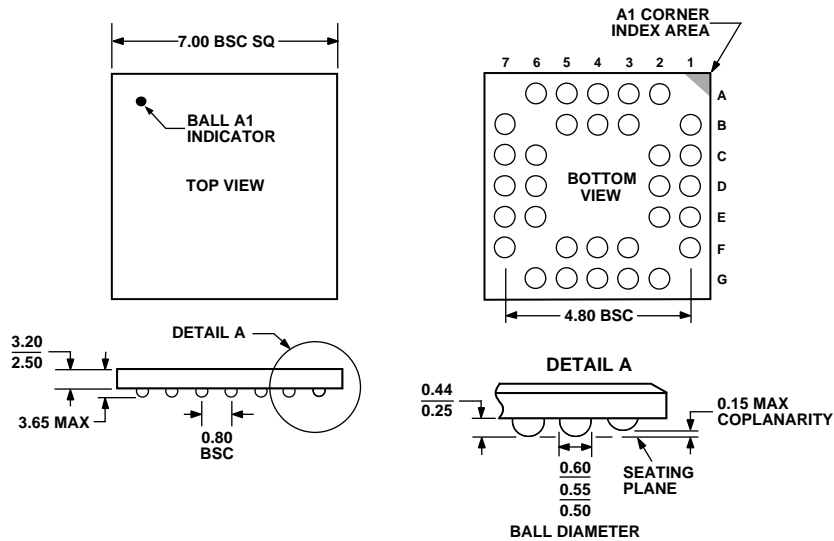

Figure 21. 32-Lead Chip Scale Ball Grid Array [CSPBGA]
(BC-32)
Dimensions shown in millimeters

ORDERING GUIDE

| Model | Temperature Range | Package Description | Package Outline |
|------------------|-------------------|---------------------|-----------------|
| ADXRS401ABG | -40°C to +85°C | 32-Lead BGA | BC-32 |
| ADXRS401ABG-REEL | -40°C to +85°C | 32-Lead BGA | BC-32 |
| ADXRS401EB | | Evaluation Board | |