

# 2.50mm (0.098") PITCH CONNECTOR

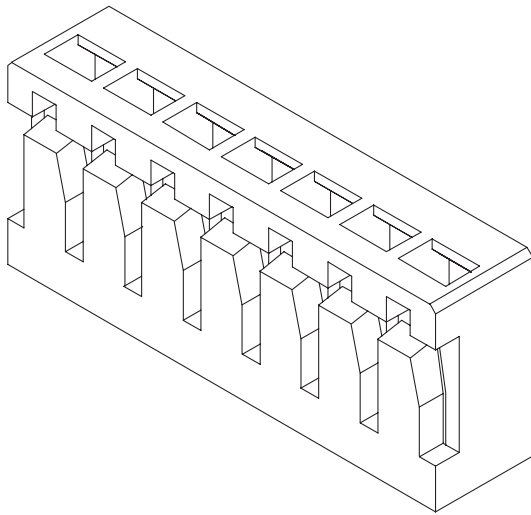

**Board-In Housing**

**YBH250 Series**



## Material

| I/NO | DESCRIPTION | TITLE  | MATERIAL           |
|------|-------------|--------|--------------------|
| 1    | HOUSING     | YBH250 | PA66, UL94 V Grade |

## Available Pin

| PARTS NO. | DIM. A | DIM. B |
|-----------|--------|--------|
| YBH250-02 | 6.0    | 2.5    |
| YBH250-03 | 8.5    | 5.0    |
| YBH250-04 | 11.0   | 7.5    |
| YBH250-05 | 13.5   | 10.0   |
| YBH250-06 | 16.0   | 12.5   |
| YBH250-07 | 18.5   | 15.0   |
| YBH250-08 | 21.0   | 17.5   |
| YBH250-09 | 23.5   | 20.0   |
| YBH250-10 | 26.0   | 22.5   |
| YBH250-11 | 28.5   | 25.0   |
| YBH250-12 | 31.0   | 27.5   |
| YBH250-13 | 33.5   | 30.0   |
| YBH250-14 | 36.0   | 32.5   |
| YBH250-15 | 38.5   | 35.0   |

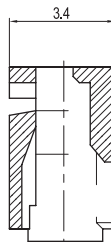
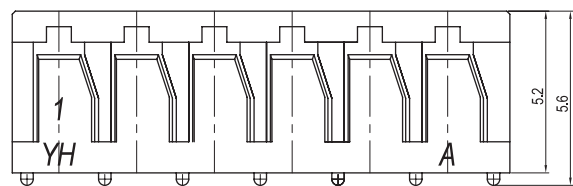
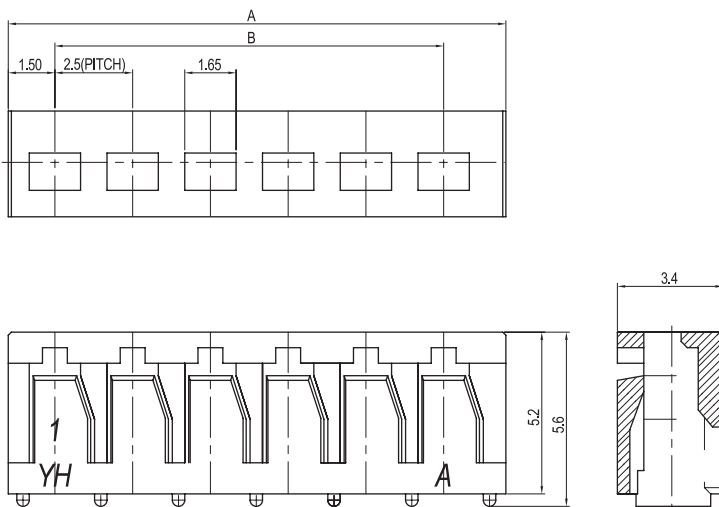

## Specification

| ITEM                   | SPEC          |
|------------------------|---------------|
| Voltage Rating         | AC/DC 250V    |
| Current Rating         | AC/DC 2A      |
| Operating Temperature  | -25°C ~ +85°C |
| Contact Resistance     | -             |
| Withstanding Voltage   | AC1000V/1min  |
| Insulation Resistance  | 1000MΩ MIN    |
| Applicable Wire        | AWG #26~#30   |
| Applicable P.C.B       | 1.2~1.6mm     |
| Applicable FPC/FFC     | -             |
| Solder Height          | -             |
| Crimp Tensile Strength | -             |
| UL FILE NO             | -             |

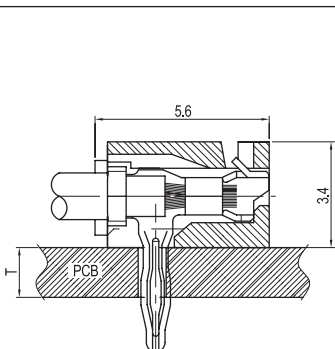

TERMINAL ASSEMBLY DRAWING

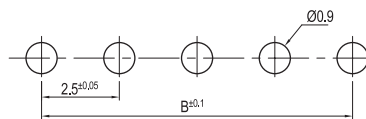

PCB LAYOUT

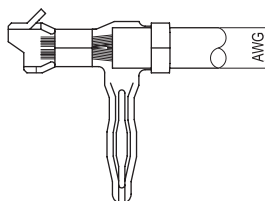

AWG : #26 ~ #30

Application Terminal : YBAT200 (110 page)