

Netz-Thyristor-Modul  
Phase Control Thyristor Modul

TT70N

TT70N

TD70N

**Elektrische Eigenschaften / Electrical properties**

Höchstzulässige Werte / Maximum rated values

Periodische Vorwärts- und Rückwärts-Spitzenspannung repetitive peak forward off-state and reverse voltages	$T_{vj} = -40^{\circ}\text{C} \dots T_{vj \max}$	$V_{\text{DRM}}, V_{\text{RRM}}$	1600 2000 2400	1800 2200 2400	V V V
Vorwärts-Stoßspitzenspannung non-repetitive peak forward off-state voltage	$T_{vj} = -40^{\circ}\text{C} \dots T_{vj \max}$	$V_{\text{DSM}}$	1600 2000 2400	1800 2200 2400	V V V
Rückwärts-Stoßspitzenspannung non-repetitive peak reverse voltage	$T_{vj} = +25^{\circ}\text{C} \dots T_{vj \max}$	$V_{\text{RSM}}$	1700 2100 2500	1900 2300 2500	V V V
Durchlaßstrom-Grenzeffektivwert maximum RMS on-state current		$I_{\text{TRMSM}}$		150	A
Dauergrenzstrom average on-state current	$T_{\text{C}} = 85^{\circ}\text{C}$ $T_{\text{C}} = 61^{\circ}\text{C}$	$I_{\text{TAVM}}$		70 96	A A
Stoßstrom-Grenzwert surge current	$T_{vj} = 25^{\circ}\text{C}, t_p = 10 \text{ ms}$ $T_{vj} = T_{vj \max}, t_p = 10 \text{ ms}$	$I_{\text{TSM}}$		1650 1450	A A
Grenzlastintegral $I^2t$ -value	$T_{vj} = 25^{\circ}\text{C}, t_p = 10 \text{ ms}$ $T_{vj} = T_{vj \max}, t_p = 10 \text{ ms}$	$I^2t$		13600 10500	$\text{A}^2\text{s}$ $\text{A}^2\text{s}$
Kritische Stromsteilheit critical rate of rise of on-state current	DIN IEC 747-6 $f = 50 \text{ Hz}, i_{\text{GM}} = 1 \text{ A}, di_{\text{G}}/dt = 1 \text{ A}/\mu\text{s}$	$(di_{\text{T}}/dt)_{\text{cr}}$		100	$\text{A}/\mu\text{s}$
Kritische Spannungssteilheit critical rate of rise of off-state voltage	$T_{vj} = T_{vj \max}, v_{\text{D}} = 0,67 V_{\text{DRM}}$ 6.Kennbuchstabe / 6 <sup>th</sup> letter C 6.Kennbuchstabe / 6 <sup>th</sup> letter F	$(dv_{\text{D}}/dt)_{\text{cr}}$		500 1000	$\text{V}/\mu\text{s}$ $\text{V}/\mu\text{s}$

**Charakteristische Werte / Characteristic values**

Durchlaßspannung on-state voltage	$T_{vj} = T_{vj \max}, i_{\text{T}} = 300 \text{ A}$	$v_{\text{T}}$	max.	2,25	V
Schleusenspannung threshold voltage	$T_{vj} = T_{vj \max}$	$V_{(\text{TO})}$		1	V
Ersatzwiderstand slope resistance	$T_{vj} = T_{vj \max}$	$r_{\text{T}}$		3,8	$\text{m}\Omega$
Zündstrom gate trigger current	$T_{vj} = 25^{\circ}\text{C}, v_{\text{D}} = 6 \text{ V}$	$I_{\text{GT}}$	max.	200	mA
Zündspannung gate trigger voltage	$T_{vj} = 25^{\circ}\text{C}, v_{\text{D}} = 6 \text{ V}$	$V_{\text{GT}}$	max.	2	V
Nicht zündender Steuerstrom gate non-trigger current	$T_{vj} = T_{vj \max}, v_{\text{D}} = 6 \text{ V}$ $T_{vj} = T_{vj \max}, v_{\text{D}} = 0,5 V_{\text{DRM}}$	$I_{\text{GD}}$	max. max.	10 5	mA mA
Nicht zündende Steuerspannung gate non-trigger voltage	$T_{vj} = T_{vj \max}, v_{\text{D}} = 0,5 V_{\text{DRM}}$	$V_{\text{GD}}$	max.	0,25	V
Haltestrom holding current	$T_{vj} = 25^{\circ}\text{C}, v_{\text{D}} = 6 \text{ V}, R_{\text{A}} = 5 \Omega$	$I_{\text{H}}$	max.	300	mA
Einraststrom latching current	$T_{vj} = 25^{\circ}\text{C}, v_{\text{D}} = 6 \text{ V}, R_{\text{GK}} \geq 10 \Omega$ $i_{\text{GM}} = 1 \text{ A}, di_{\text{G}}/dt = 1 \text{ A}/\mu\text{s}, t_{\text{g}} = 20 \mu\text{s}$	$I_{\text{L}}$	max.	1200	mA
Vorwärts- und Rückwärts-Sperrstrom forward off-state and reverse current	$T_{vj} = T_{vj \max}$ $v_{\text{D}} = V_{\text{DRM}}, v_{\text{R}} = V_{\text{RRM}}$	$i_{\text{D}}, i_{\text{R}}$	max.	25	mA
Zündverzug gate controlled delay time	DIN IEC 747-6 $T_{vj} = 25^{\circ}\text{C}, i_{\text{GM}} = 1 \text{ A}, di_{\text{G}}/dt = 1 \text{ A}/\mu\text{s}$	$t_{\text{gd}}$	max.	4	$\mu\text{s}$

1) 2400V auf Anfrage / 2400V on request

prepared by:	C. Drilling	date of publication:	18.12.01
approved by:	J. Novotny	Revision:	1

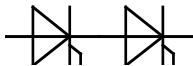
**Netz-Thyristor-Modul**  
**Phase Control Thyristor Modul**
**TT70N**
**Elektrische Eigenschaften / Electrical properties**

Charakteristische Werte / Characteristic values

Freiwerdezeit circuit commutated turn-off time	$T_{vj} = T_{vj\ max}$ , $i_{TM} = I_{TAVM}$ $V_{RM} = 100\ V$ , $V_{DM} = 0,67\ V_{DRM}$ $dv_D/dt = 20\ V/\mu s$ , $-di_T/dt = 10\ A/\mu s$ 5.Kennbuchstabe / 5 <sup>th</sup> letter O	$t_q$	typ.	300	$\mu s$
Isolations-Prüfspannung insulation test voltage	RMS, $f = 50\ Hz$ , $t = 1\ min$ RMS, $f = 50\ Hz$ , $t = 1\ sec$	$V_{ISOL}$		3,0 3,6	kV kV

**Thermische Eigenschaften / Thermal properties**

Innerer Wärmewiderstand thermal resistance, junction to case	pro Modul / per Module, $\Theta = 180^\circ\ sin$ pro Zweig / per arm, $\Theta = 180^\circ\ sin$ pro Modul / per Module, DC pro Zweig / per arm, DC	$R_{thJC}$	max.	0,175	$^\circ C/W$
			max.	0,350	$^\circ C/W$
			max.	0,165	$^\circ C/W$
			max.	0,330	$^\circ C/W$
Übergangs-Wärmewiderstand thermal resistance, case to heatsink	pro Modul / per Module pro Zweig / per arm	$R_{thCH}$	max.	0,04	$^\circ C/W$
			max.	0,08	$^\circ C/W$
Höchstzulässige Sperrschichttemperatur maximum junction temperature		$T_{vj\ max}$		125	$^\circ C$
Betriebstemperatur operating temperature		$T_{c\ op}$		-40...+125	$^\circ C$
Lagertemperatur storage temperature		$T_{stg}$		-40...+130	$^\circ C$

**Mechanische Eigenschaften / Mechanical properties**

Gehäuse, siehe Anlage case, see annex				Seite 3 page 3	
Si-Element mit Druckkontakt Si-pellet with pressure contact					
Innere Isolation internal insulation				AIN	
Anzugsdrehmoment für mechanische Anschlüsse mounting torque	Toleranz / Tolerance $\pm 15\%$	M1		4	Nm
Anzugsdrehmoment für elektrische Anschlüsse terminal connection torque	Toleranz / Tolerance $+ 5\% / - 10\%$	M2		4	Nm
Steueranschlüsse control terminals	DIN 46 244			A 2,8 x 0,8	
Gewicht weight		G	typ.	250	g
Kriechstrecke creepage distance				15	mm
Schwingfestigkeit vibration resistance	$f = 50\ Hz$			50	$m/s^2$
UL-gelistet UL listed	file-No.			E 83336	

Mit diesem Datenblatt werden Halbleiterbauelemente spezifiziert, jedoch keine Eigenschaften zugesichert. Sie gilt in Verbindung mit den zugehörigen technischen Erläuterungen.

This data sheet specifies semiconductor devices, but promises no characteristics. It is valid in combination with the belonging technical notes.

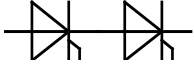

Netz-Thyristor-Modul  
Phase Control Thyristor Modul

**TT70N**

screwing depth  
max. 8.5

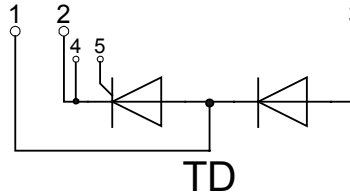
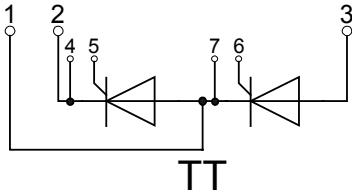
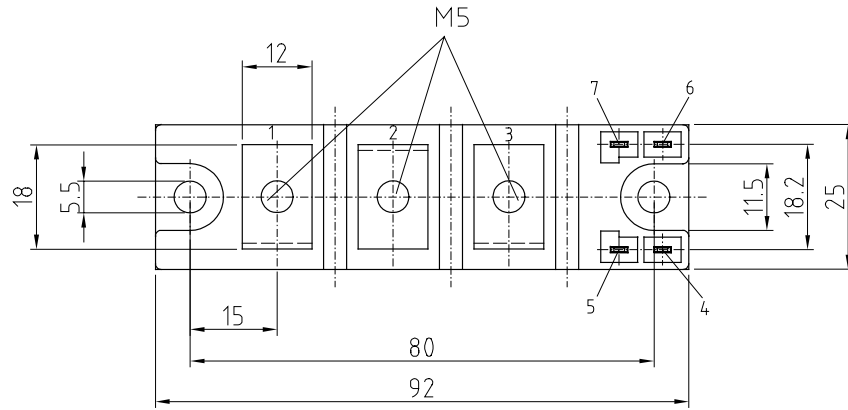
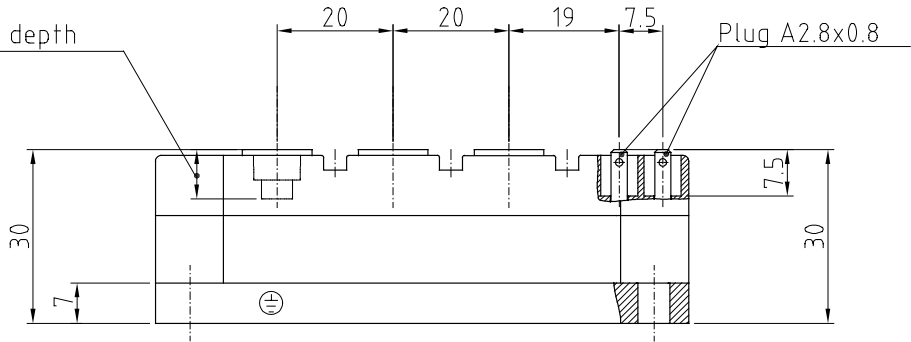

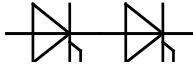

Netz-Thyristor-Modul  
Phase Control Thyristor Modul

**TT70N**

**Analytische Elemente des transienten Wärmewiderstandes  $Z_{thJC}$  für DC**  
**Analytical elements of transient thermal impedance  $Z_{thJC}$  for DC**

Pos. n	1	2	3	4	5	6	7
$R_{thn}$ [°C/W]	0,0127	0,03	0,049	0,1318	0,1085		
$\tau_n$ [s]	0,001	0,0092	0,074	0,57	3,51		

Analytische Funktion / Analytical function: 
$$Z_{thJC} = \sum_{n=1}^{n_{max}} R_{thn} \left( 1 - e^{-\frac{t}{\tau_n}} \right)$$

Natürliche Kühlung / Natural cooling  
3 Module pro Kühler / 3 modules per heatsink  
Kühler / Heatsink type: KM14 (50W)

**Analytische Elemente des transienten Wärmewiderstandes  $Z_{thCA}$**   
**Analytical elements of transient thermal impedance  $Z_{thCA}$**

Pos. n	1	2	3	4	5	6	7
$R_{thn}$ [°C/W]	0,048	0,202	2,05				
$\tau_n$ [s]	3,71	40	984				

Verstärkte Kühlung / Forced cooling  
3 Module pro Kühler / 3 modules per heatsink  
Kühler / Heatsink type: KM 14 (Papst 4650N)

**Analytische Elemente des transienten Wärmewiderstandes  $Z_{thCA}$**   
**Analytical elements of transient thermal impedance  $Z_{thCA}$**

Pos. n	1	2	3	4	5	6	7
$R_{thn}$ [°C/W]	0,048	0,202	0,53				
$\tau_n$ [s]	3,71	40	254				

Analytische Funktion / Analytical function: 
$$Z_{thCA} = \sum_{n=1}^{n_{max}} R_{thn} \left( 1 - e^{-\frac{t}{\tau_n}} \right)$$

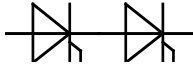

Netz-Thyristor-Modul  
Phase Control Thyristor Modul

TT70N

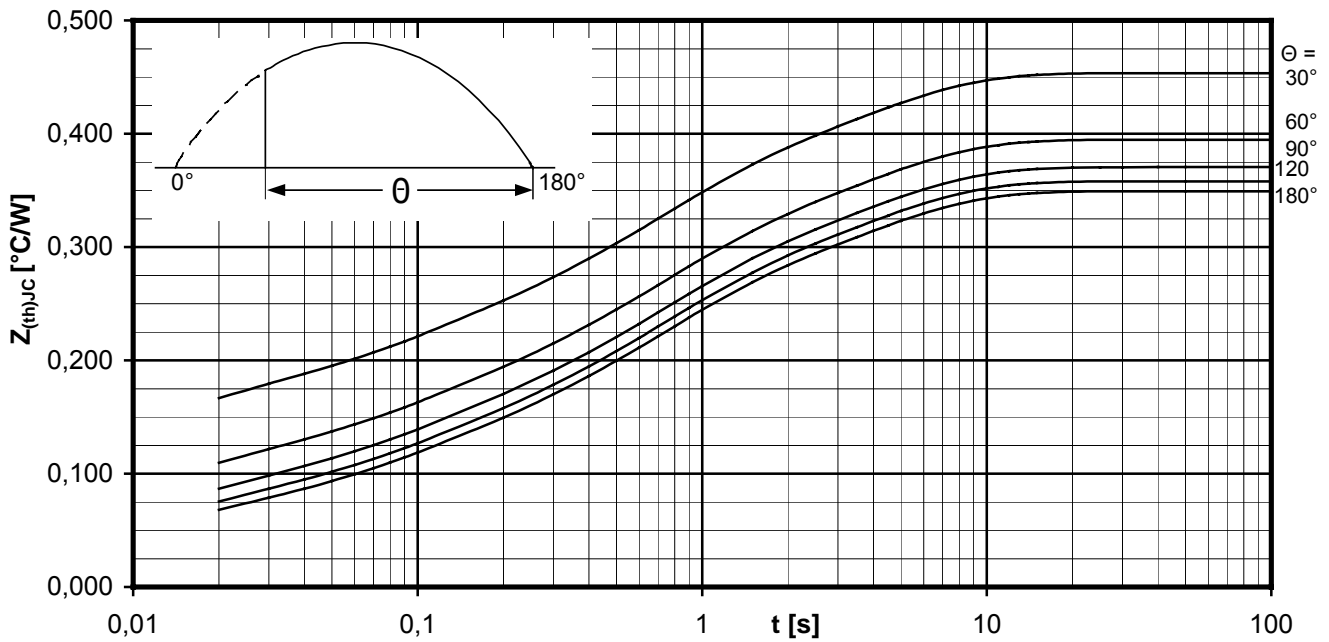

Transienter innerer Wärmewiderstand je Zweig / Transient thermal impedance per arm  $Z_{thJC} = f(t)$

Sinusförmiger Strom / Sinusoidal current

Parameter: Stromflußwinkel  $\Theta$  / Current conduction angle  $\Theta$

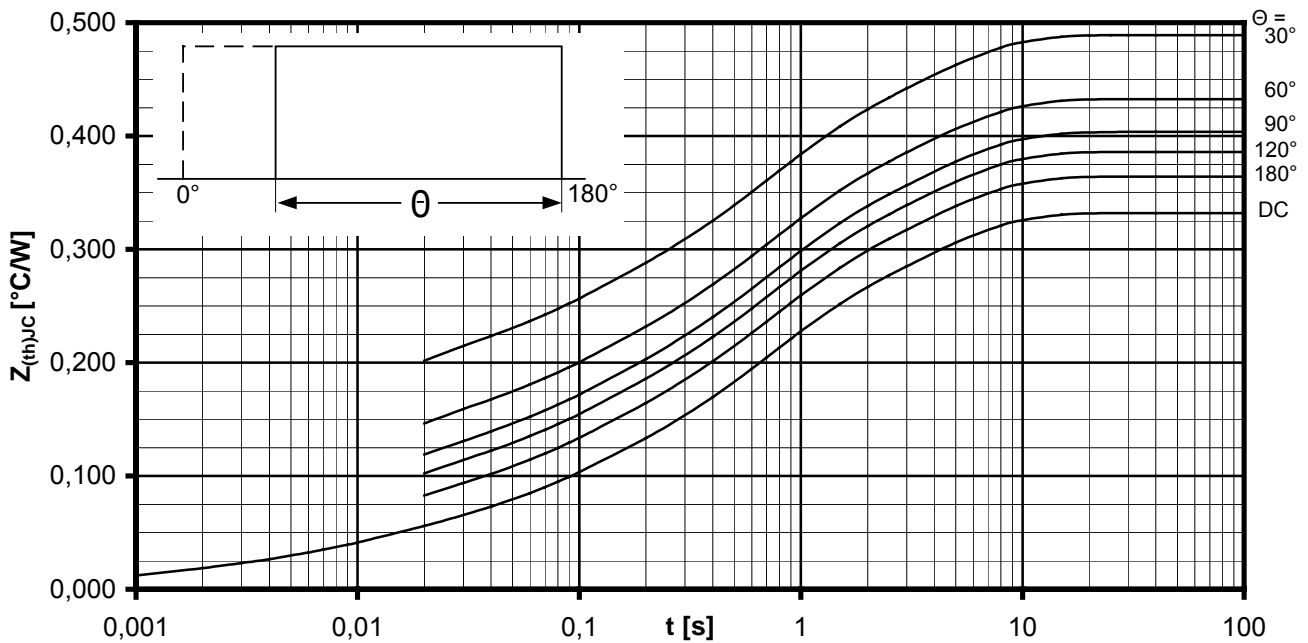

Transienter innerer Wärmewiderstand je Zweig / Transient thermal impedance per arm  $Z_{thJC} = f(t)$

Rechteckförmiger Strom / Rectangular current

Parameter: Stromflußwinkel  $\Theta$  / Current conduction angle  $\Theta$

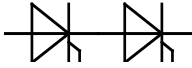

Netz-Thyristor-Modul  
Phase Control Thyristor Modul

TT70N

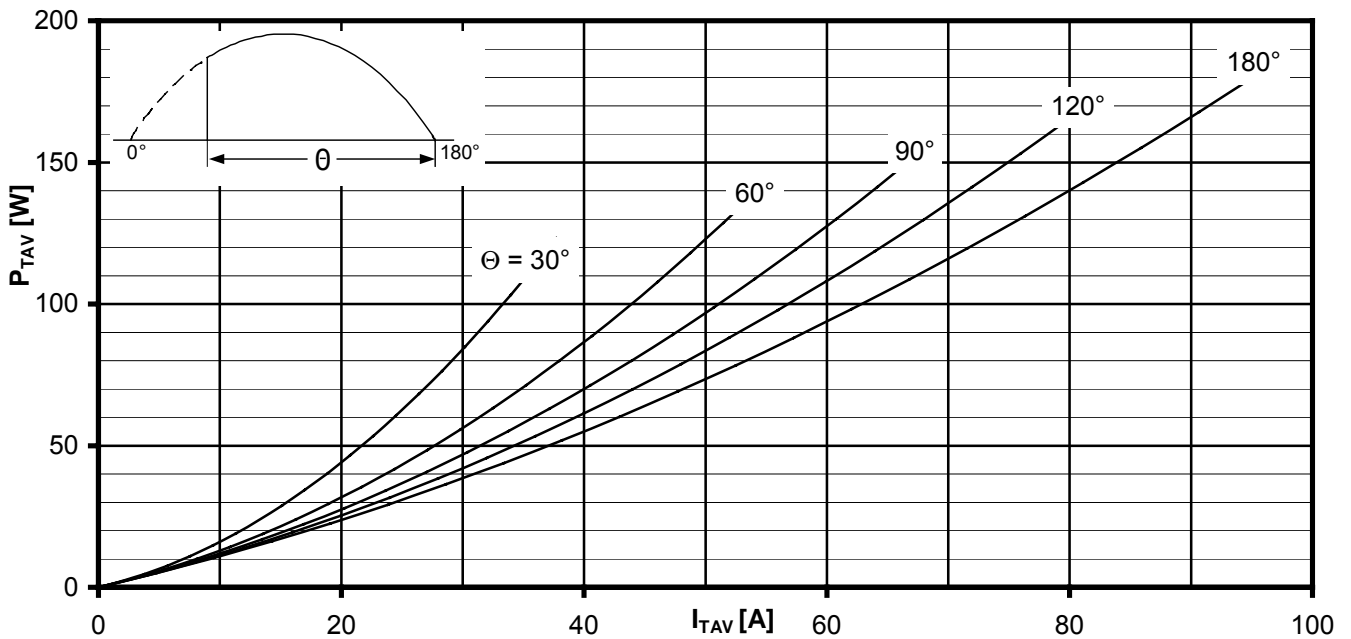

Durchlassverlustleistung je Zweig / On-state power loss per arm  $P_{TAV} = f(I_{TAV})$

Sinusförmiger Strom / Sinusoidal current    Strombelastung je Zweig / Current load per arm

**Berechnungsgrundlage  $P_{TAV}$  (Schaltverluste gesondert berücksichtigen)**  
**Calculation base  $P_{TAV}$  (switching losses should be considered separately)**

Parameter: Stromflußwinkel / Current conduction angle  $\Theta$

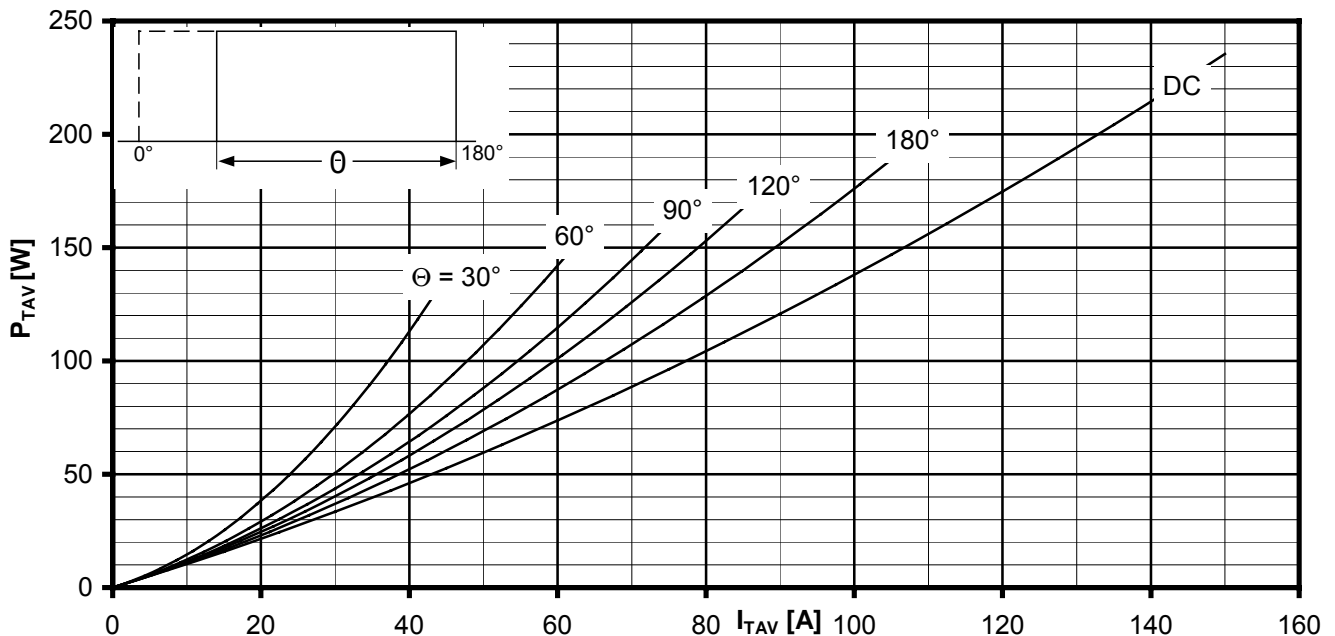

Durchlassverlustleistung je Zweig / On-state power loss per arm  $P_{TAV} = f(I_{TAV})$

Rechteckförmiger Strom / Rectangular current    Strombelastung je Zweig / Current load per arm

**Berechnungsgrundlage  $P_{TAV}$  (Schaltverluste gesondert berücksichtigen)**  
**Calculation base  $P_{TAV}$  (switching losses should be considered separately)**

Parameter: Stromflußwinkel / Current conduction angle  $\Theta$

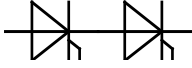

Netz-Thyristor-Modul  
Phase Control Thyristor Modul

TT70N

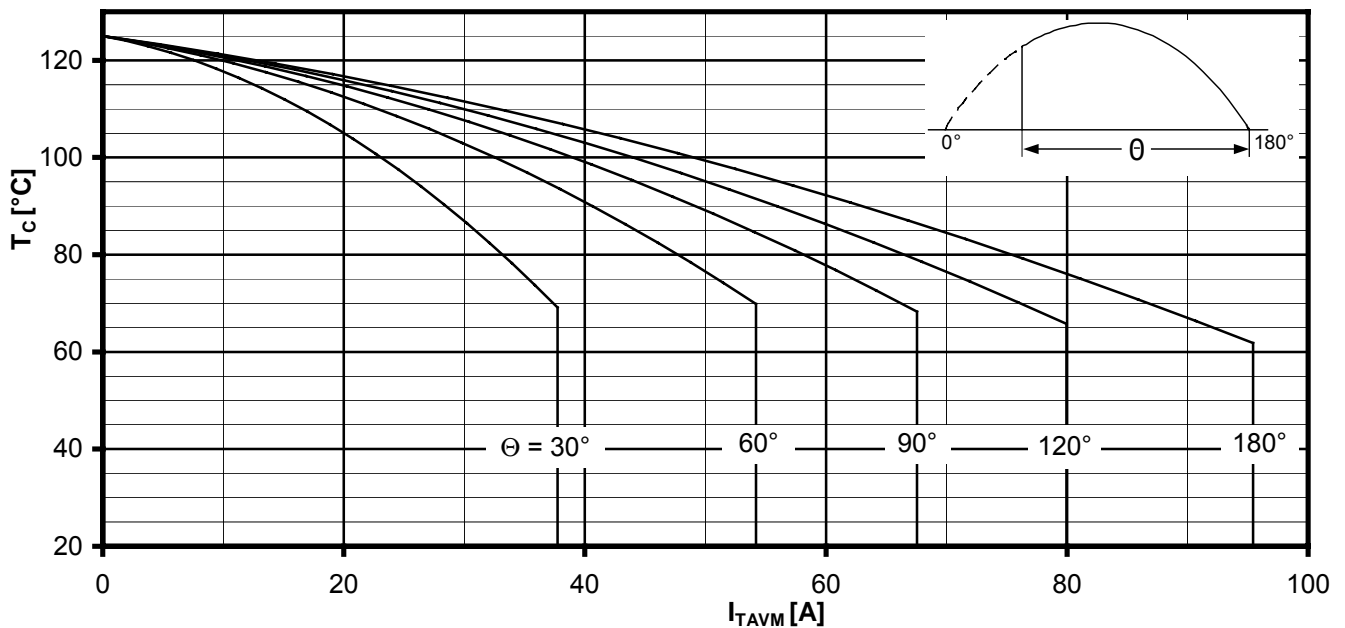

Höchstzulässige Gehäusetemperatur / Maximum allowable case temperature  $T_C = f(I_{TAVM})$

Sinusförmiger Strom / Sinusoidal current Strombelastung je Zweig / Current load per arm

Berechnungsgrundlage  $P_{TAV}$  (Schaltverluste gesondert berücksichtigen)  
Calculation base  $P_{TAV}$  (switching losses should be considered separately)

Parameter: Stromflußwinkel  $\Theta$  / Current conduction angle  $\Theta$

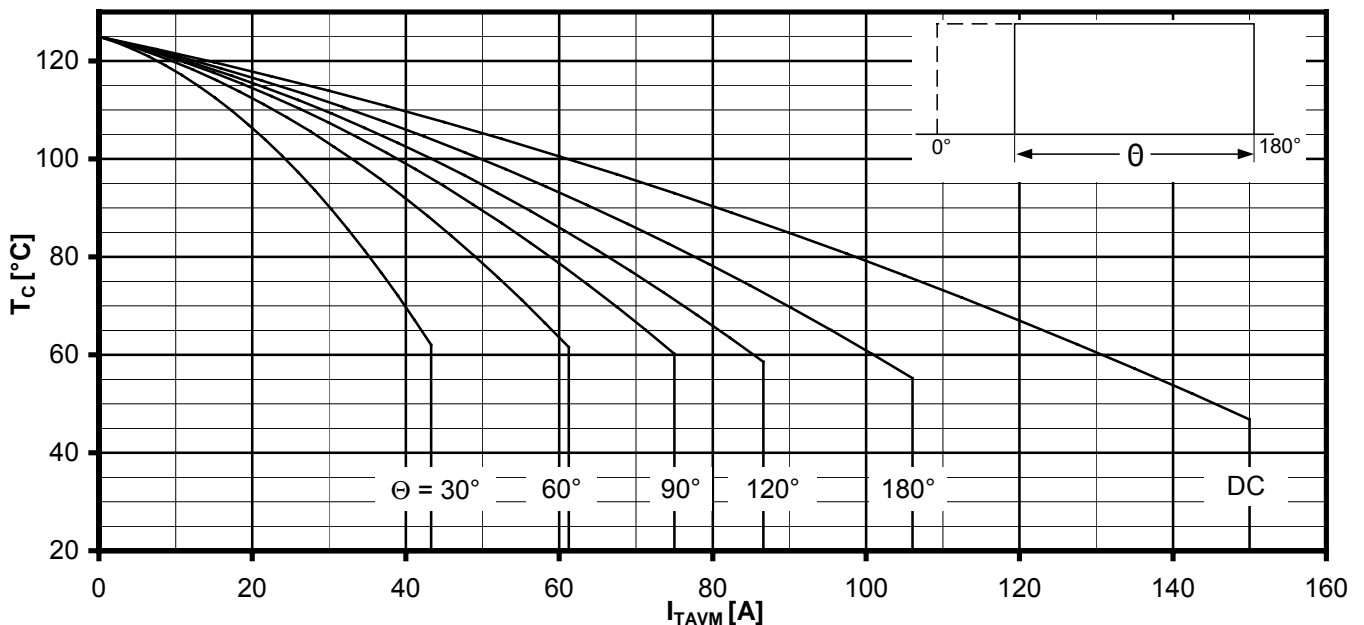

Höchstzulässige Gehäusetemperatur / Maximum allowable case temperature  $T_C = f(I_{TAVM})$

Rechteckförmiger Strom / Rectangular current Strombelastung je Zweig / Current load per arm

Berechnungsgrundlage  $P_{TAV}$  (Schaltverluste gesondert berücksichtigen)  
Calculation base  $P_{TAV}$  (switching losses should be considered separately)

Parameter: Stromflußwinkel  $\Theta$  / Current conduction angle  $\Theta$

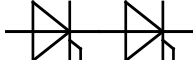

Netz-Thyristor-Modul  
Phase Control Thyristor Modul

TT70N

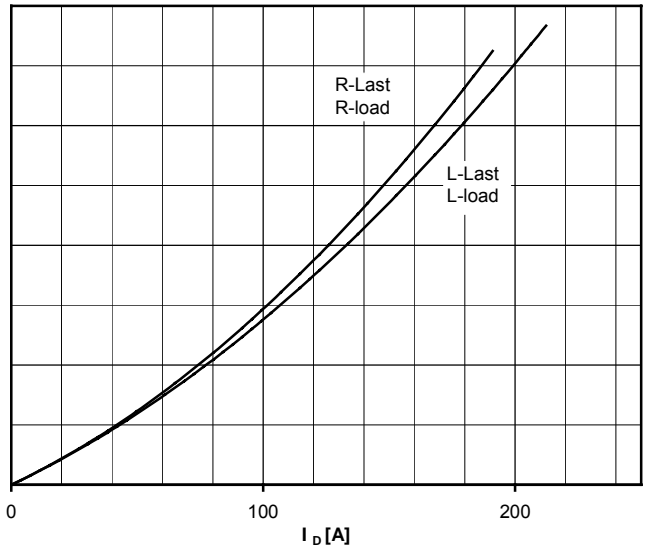
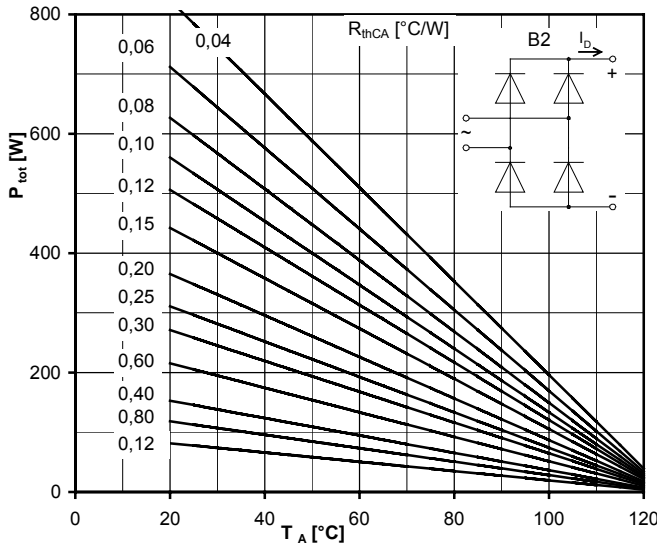

Höchstzulässiger Ausgangsstrom / Maximum rated output current  $I_D$

B2- Zweipuls-Brückenschaltung / Two-pulse bridge circuit

Gesamtverlustleistung der Schaltung / Total power dissipation at circuit  $P_{tot}$

Parameter:

Wärmewiderstand zwischen den Gehäusen und Umgebung / Thermal resistance cases to ambient  $R_{thCA}$

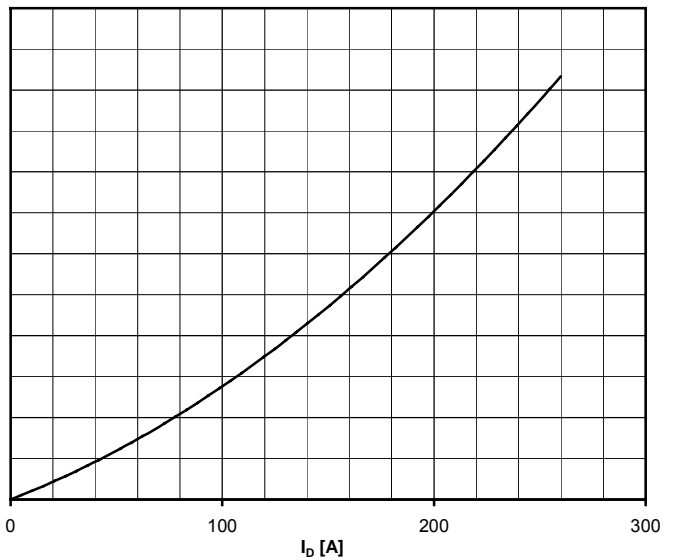
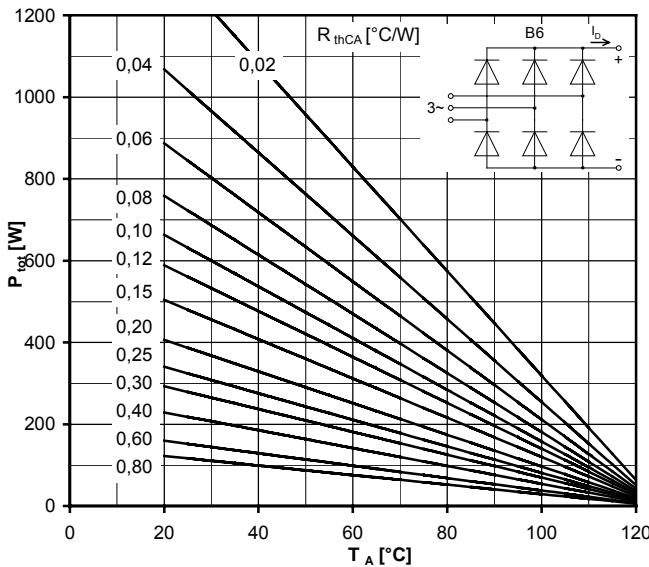

Höchstzulässiger Ausgangsstrom / Maximum rated output current  $I_D$

B6- Sechspuls-Brückenschaltung / Six-pulse bridge circuit

Gesamtverlustleistung der Schaltung / Total power dissipation at circuit  $P_{tot}$

Parameter:

Wärmewiderstand zwischen den Gehäusen und Umgebung / Thermal resistance cases to ambient  $R_{thCA}$



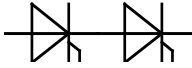

Netz-Thyristor-Modul  
Phase Control Thyristor Modul

TT70N

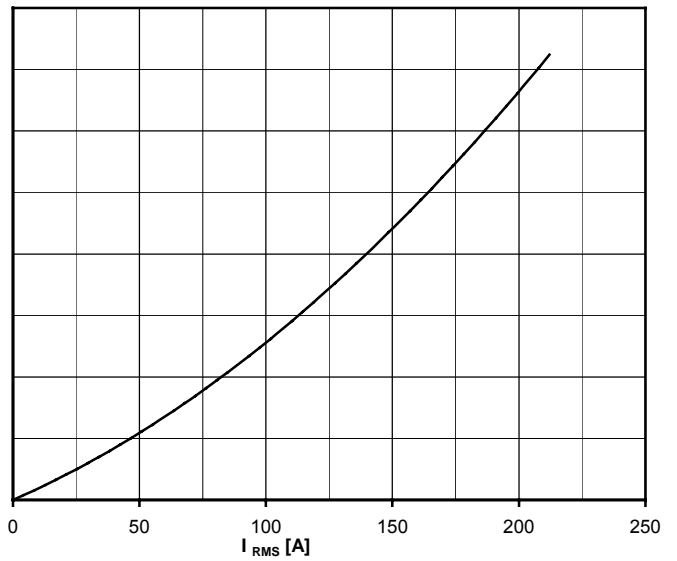
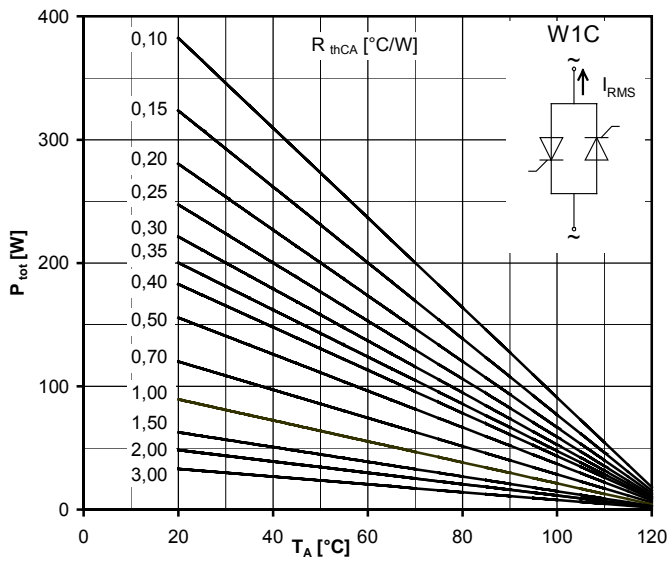

Höchstzulässiger Effektivstrom / Maximum rated RMS current  $I_{RMS}$

W1C - Einphasen-Wechselwegschaltung / Single-phase inverse parallel circuit

Gesamtverlustleistung der Schaltung / Total power dissipation at circuit  $P_{tot}$

Parameter:

Wärmewiderstand zwischen den Gehäusen und Umgebung / Thermal resistance case to ambient  $R_{thCA}$

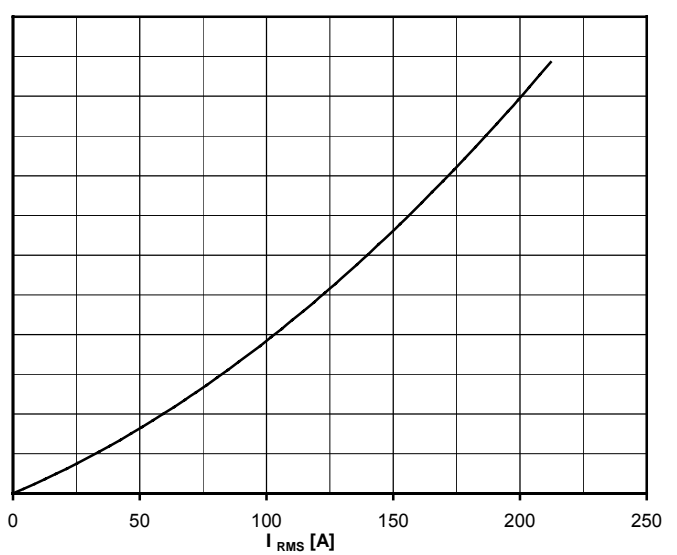
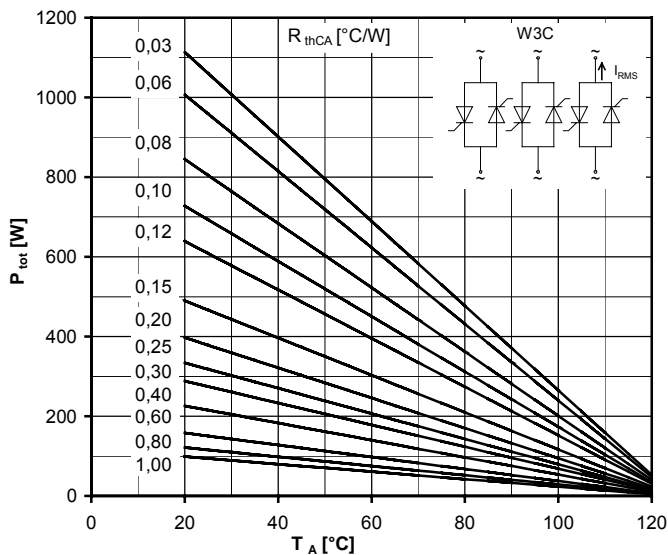

Höchstzulässiger Effektivstrom / Maximum rated RMS current  $I_{RMS}$

W3C - Dreiphasen-Wechselwegschaltung / Three-phase inverse parallel circuit

Gesamtverlustleistung der Schaltung / Total power dissipation at circuit  $P_{tot}$

Parameter:

Wärmewiderstand zwischen den Gehäusen und Umgebung / Thermal resistance cases to ambient  $R_{thCA}$

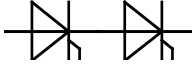

Netz-Thyristor-Modul  
Phase Control Thyristor Modul

TT70N

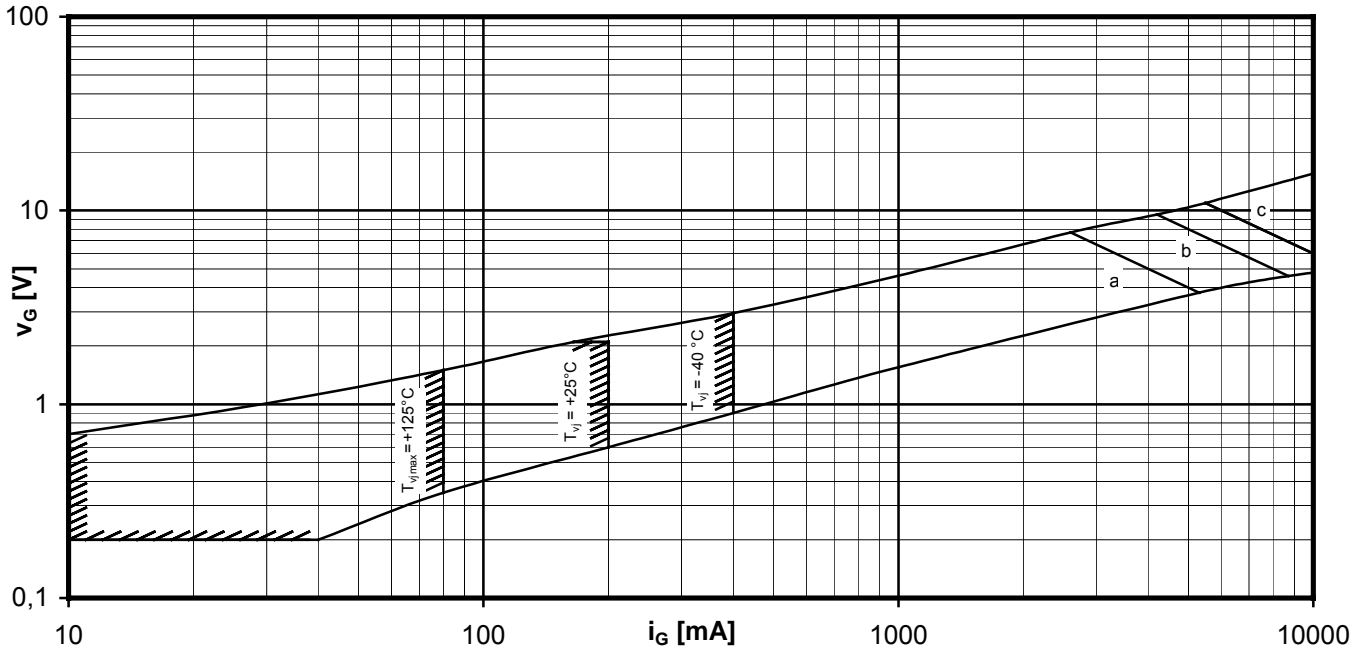

Steuercharakteristik  $v_G = f(i_G)$  mit Zündbereichen für  $V_D = 6\text{ V}$   
Gate characteristic  $v_G = f(i_G)$  with triggering area for  $V_D = 6\text{ V}$

Höchstzulässige Spitzensteuerverlustleistung / Maximum rated peak gate power dissipation  $P_{GM} = f(t_g)$  :

a - 20 W/10ms    b - 40 W/1ms    c - 60 W/0,5ms

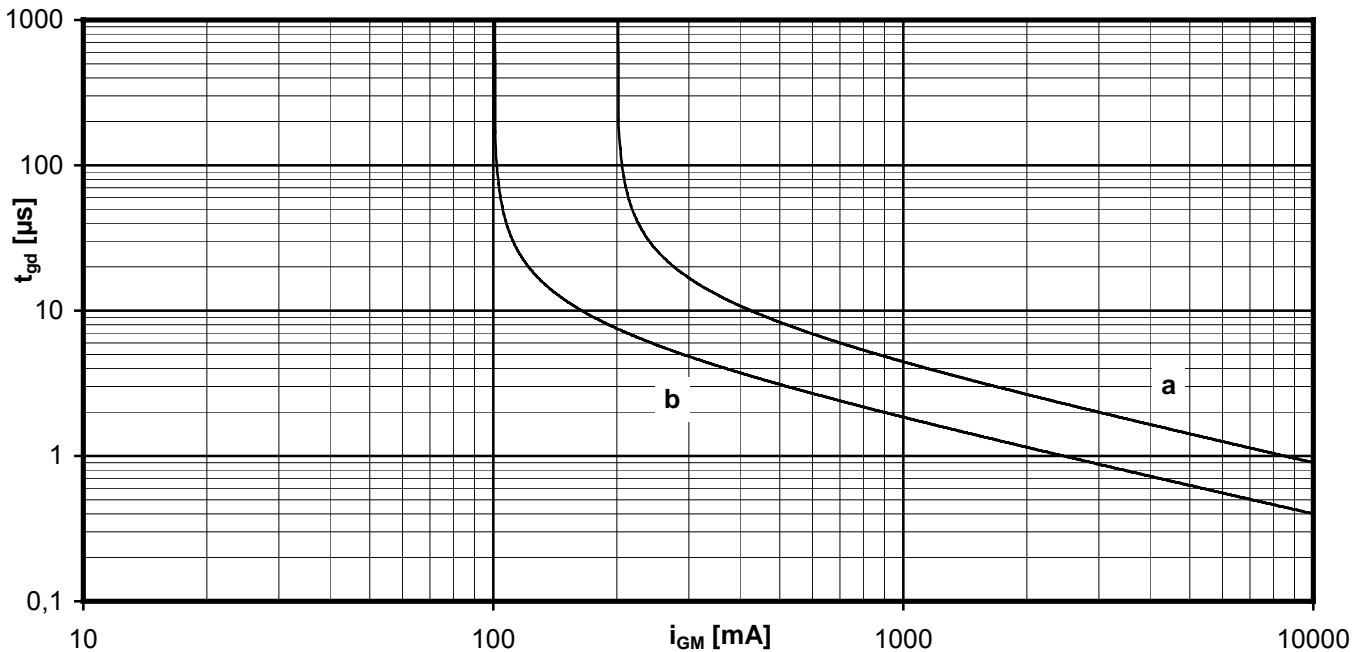

Zündverzug / Gate controlled delay time  $t_{gd} = f(i_{GM})$

$T_{vj} = 25^\circ\text{C}$ ,  $di_G/dt = i_{GM}/1\mu\text{s}$

a - maximaler Verlauf / Limiting characteristic

b - typischer Verlauf / Typical characteristic

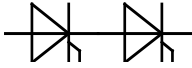

Netz-Thyristor-Modul  
Phase Control Thyristor Modul

TT70N

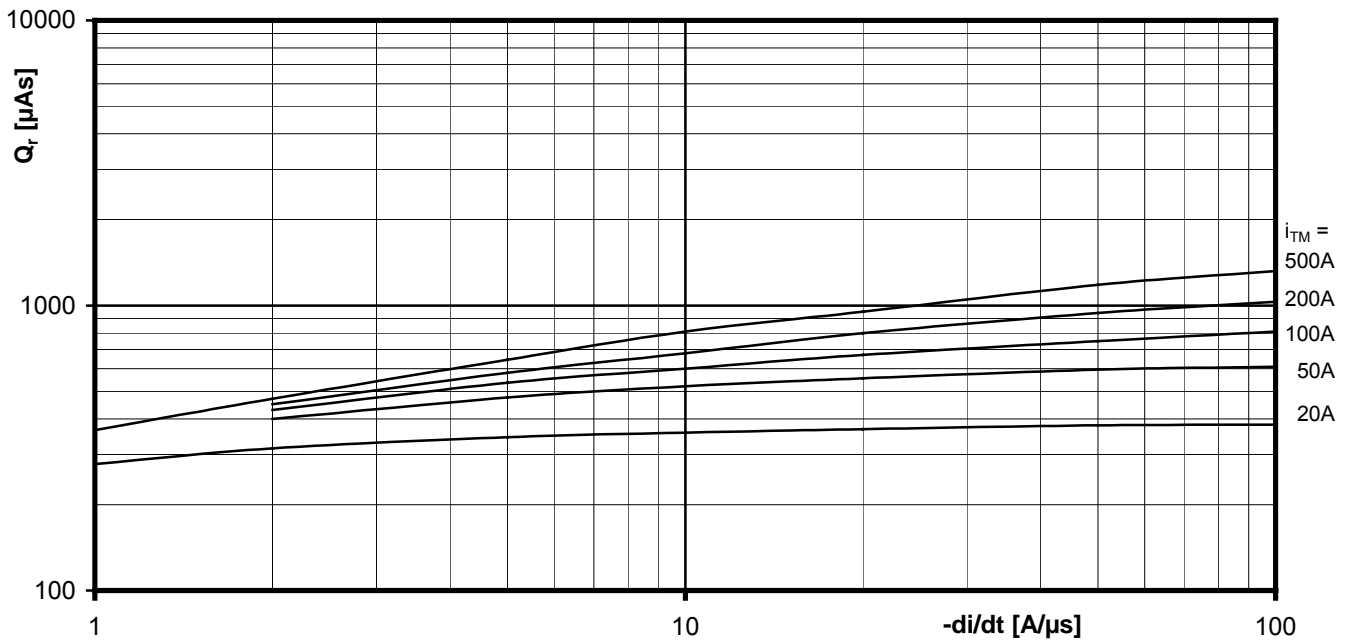

Sperrverzögerungsladung / Recovered charge  $Q_r = f(-di/dt)$

$$T_{vj} = T_{vjmax}, V_R \leq 0,5 V_{RRM}, V_{RM} = 0,8 V_{RRM}$$

Parameter: Durchlaßstrom / On-state current  $i_{TM}$

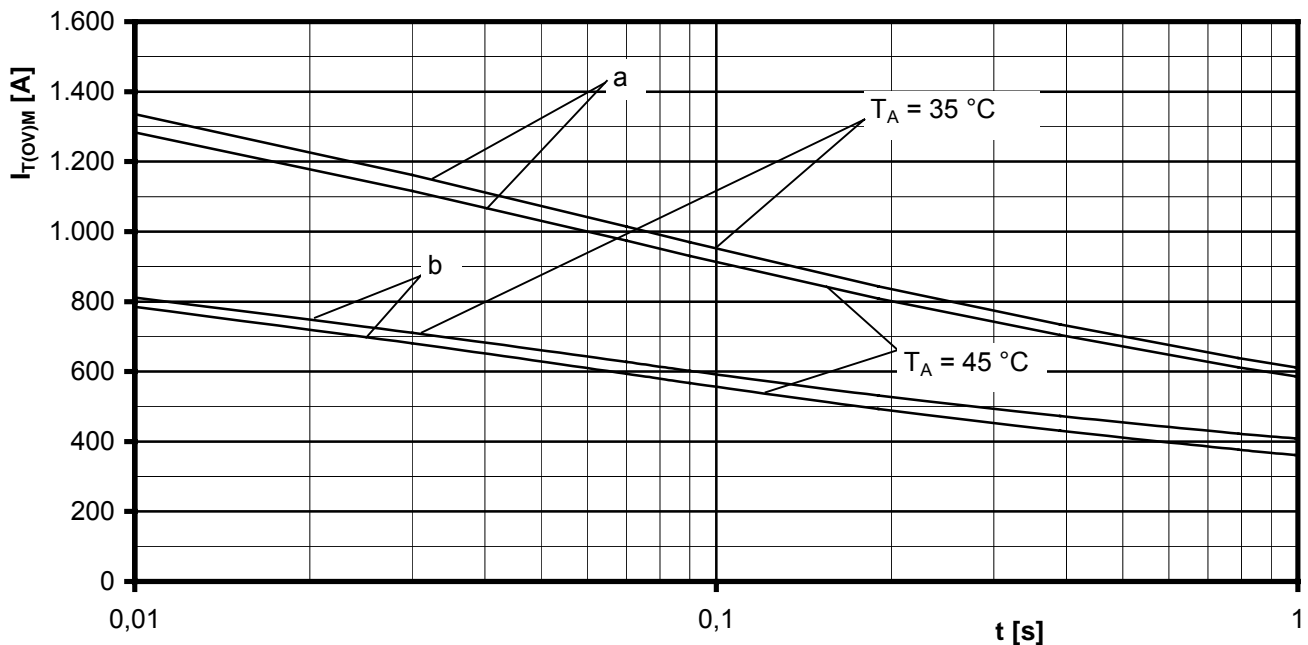

Grenzstrom / Maximum overload on-state current  $I_{T(OV)M} = f(t), v_{RM} = 0,8 V_{RRM}$

Leerlauf / No-load conditions

a:  $T_A = 35^\circ\text{C}$ , verstärkte Luftkühlung / Forced air cooling

b:  $T_A = 45^\circ\text{C}$ , natürliche Luftkühlung / Natural air cooling

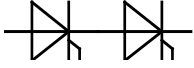

Netz-Thyristor-Modul  
Phase Control Thyristor Modul

TT70N

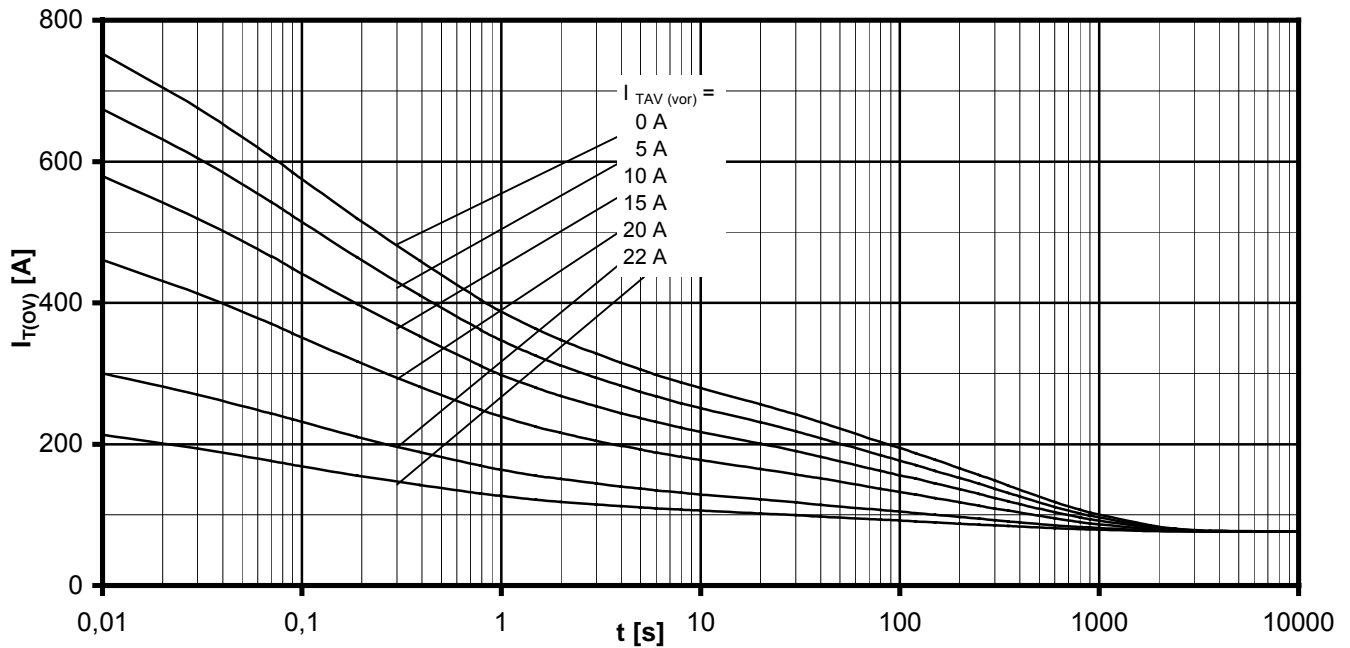

Überstrom je Zweig / Overload on-state current  $I_{F(ov)}$

B6- Sechspuls-Brückenschaltung, 120° Rechteck / Six-pulse bridge circuit, 120° rectangular

Kühlkörper / Heatsink type KM14 (50W) Natürliche Kühlung bei / Natural cooling at  $T_A = 45^\circ\text{C}$

Parameter: Vorlaststrom je Zweig / Pre-load current per arm  $I_{FAV(vor)}$

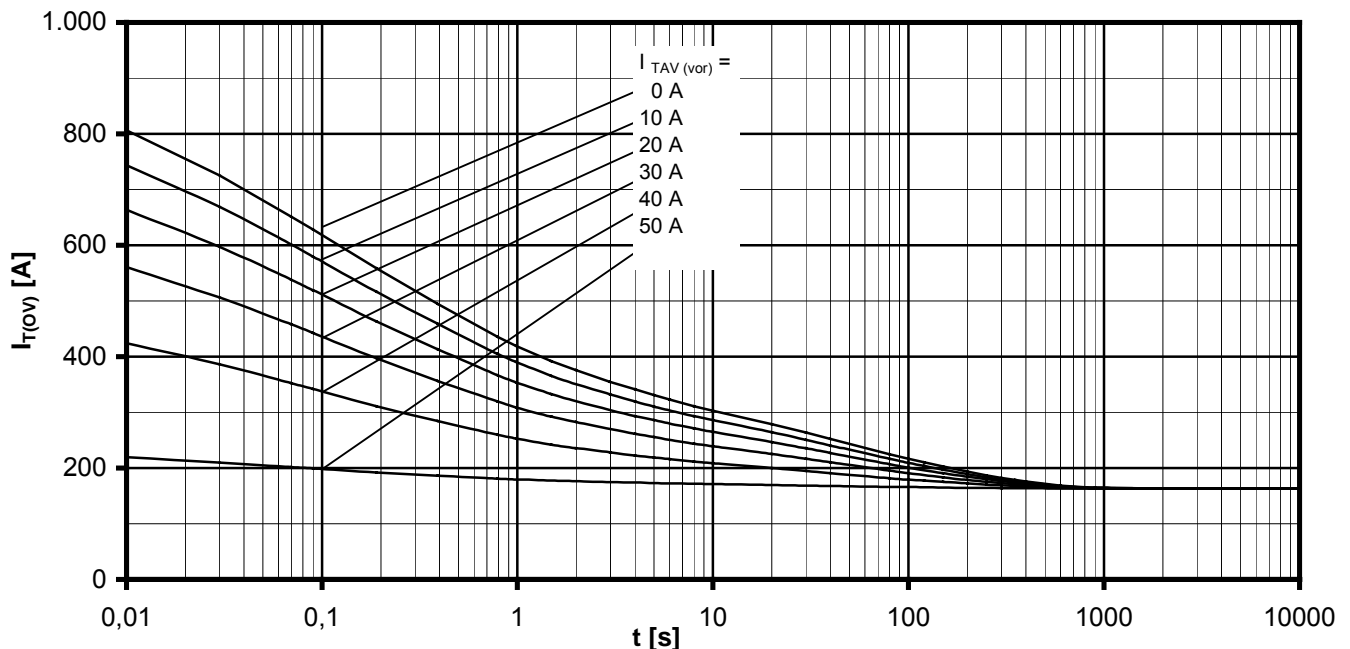

Überstrom je Zweig / Overload on-state current  $I_{F(ov)}$

B6- Sechspuls-Brückenschaltung, 120° Rechteck / Six-pulse bridge circuit, 120° rectangular

Kühlkörper / Heatsink type KM 14 Papst 4650N Verstärkte Kühlung bei / Forced cooling at  $T_A = 35^\circ\text{C}$

Parameter: Vorlaststrom je Zweig / Pre-load current per arm  $I_{FAV(vor)}$