

LTR	REVISION	DATE	APPD
-	RELEASED	03-10-05	

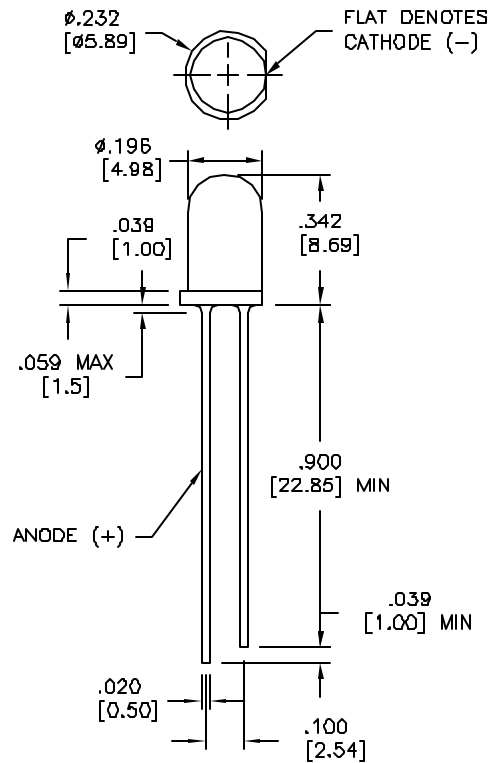

ABSOLUTE MAXIMUM RATINGS (Ta=25°C)

CHARACTERISTIC	SYMBOL	RATING	UNIT
POWER DISSIPATION	Pd	120	mW
CONT. FORWARD CURRENT	If	30	mA
PEAK FORWARD CURRENT*	I <sub>F</sub>	150	mA
REVERSE VOLTAGE	Vr	5	V
OPERATING TEMPERATURE	Topr	-40°C~80°C	°C
STORAGE TEMPERATURE	Tstg	-40°C~85°C	°C
SOLDERING TEMPERATURE	Tsol	260°C (FOR 5 SEC.)	-

\*CONDITION FOR I<sub>F</sub> IS 1/10 DUTY CYCLE, 0.1msec PULSE WIDTH

ELECTRO-OPTICAL CHARACTERISTICS (Ta=25°C)

CHARACTERISTIC	SYMBOL	CONDITION	MIN.	TYP.	MAX.	UNIT
LUMINOUS INTENSITY	Iv	If=20mA	-	1200	-	md
FORWARD VOLTAGE	Vf	If=20mA	-	3.5	3.8	V
REVERSE CURRENT	Ia	Vr=5V	-	-	100	µA
PEAK WAVELENGTH	λp	If=20mA	-	461	-	nm
DOMINATE WAVELENGTH	λD	If=20mA	-	466	-	nm
CHROMATICITY COORDINATES	X	If=20mA	-	0.14	-	-
	Y	If=20mA	-	0.48	-	-
SPECTRAL LINE HALF-WIDTH	Δλ	If=20mA	-	22	-	nm
VIEWING ANGLE	2θ1/2	If=20mA	-	45	-	deg

NOTES:

- ALL DIMS ARE IN INCHES [MILLIMETERS].
- TOLERANCE IS ±0.10" (±0.25mm) UNLESS OTHERWISE SPECIFIED.
- LEAD SPACING IS MEASURED WHERE LEADS EMERGE FROM THE PACKAGE.
- SPECIFICATIONS ARE SUBJECT TO CHANGE WITHOUT NOTICE.
- LEADS TO BE SOLDERABLE AND CAPABLE OF MEETING THE SOLDERABILITY REQUIREMENTS OF MIL-STD-202, METHOD 208.
- MANUFACTURE DATE SHALL NOT BE OLDER THAN 26 WEEKS (6 MONTHS).

RADIANT INTENSITY µW/sr (typ)
2100

PURITY (%) typ
98

L.E.D. RADIATION COLOR	LENS APPEARANCE
SUPER BLUE	WATER CLEAR

**LED**<sup>®</sup>  
LEDTRONICS, INC.<sup>™</sup>  
23105 KASHIWA COURT  
TORRANCE, CA 90505

PROPRIETARY.  
This document contains Proprietary Information of LEDTRONICS, INC. It may not be copied, used or disclosed for any purpose without the prior express written consent of LEDTRONICS, INC.

.XX ± .010 TOLERANCE PER ANSI-Y14.5  
.XX ± .025 (UNLESS OTHERWISE STATED)  
ANGLES ± 0°.30°  
FRACT. ± 1/32

TITLE L200CWBPB4KB-45D			
DWG NO DSDC349	SCALE 2:1	SHEET 1 OF 2	DATE 03-10-05
CODE IDENT NO. 8Z410	DWG BY RM	CHK BY PL	QA JCH 03-23-0503-23-05
MFG		CUSTOMER	

LTR	REVISION	DATE	APPD
-	RELEASED	03-15-05	

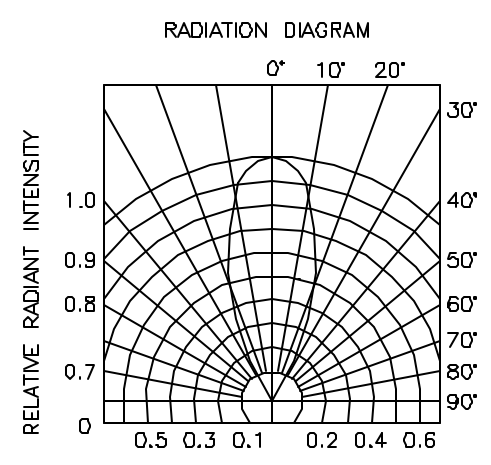
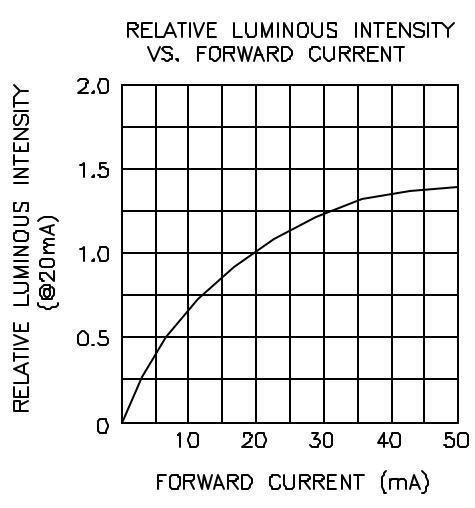
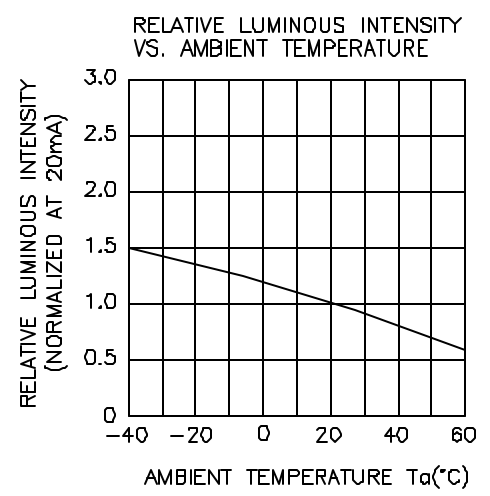
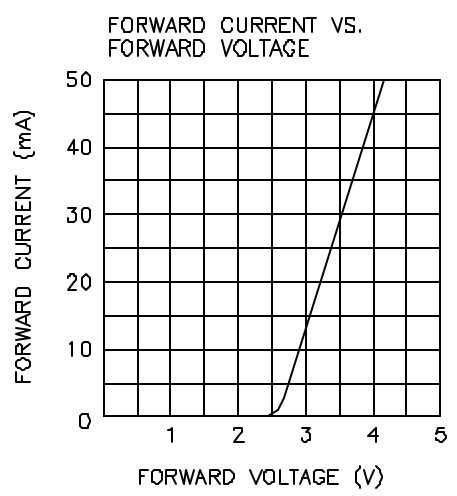
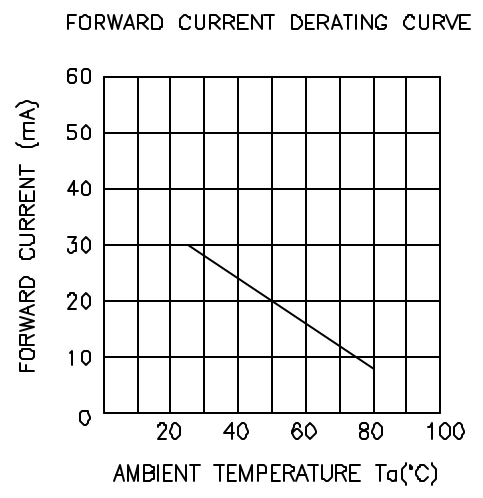
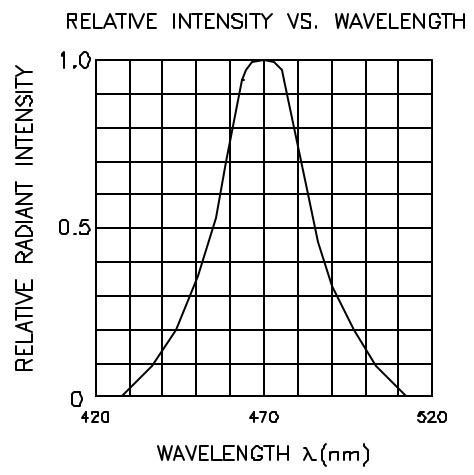

**LED**<sup>®</sup>  
**LEDTRONICS, INC.**<sup>™</sup>  
 23105 KASHIWA COURT  
 TORRANCE, CA 90505

PROPRIETARY.  
 This document contains Proprietary Information of LEDTRONICS, INC. It may not be copied, used or disclosed for any purpose without the prior express written consent of LEDTRONICS, INC.

.XXX ± .010 TOLERANCE PER ANSI-Y14.5  
 .XX ± .025 (UNLESS OTHERWISE STATED)  
 ANGLES ± 0°.30°  
 FRACT. ± 1/32

TITLE		L200CWPB4KB-45D	
DWG NO	SCALE	SHEET	DATE
DSDC0349-A	Z:1	2 OF 2	03-15-05
CODE IDENT NO.	DWG BY	CHK BY	QA
8Z410	RM	PL JCH	MFG
		03-23-05	03-23-05
CUSTOMER			