

*Single switch  
Series & parallel diodes  
MOSFET Power Module*

**$V_{DSS} = 200V$   
 $R_{DSon} = 5m\Omega$  max @  $T_j = 25^\circ C$   
 $I_D = 317A$  @  $T_c = 25^\circ C$**

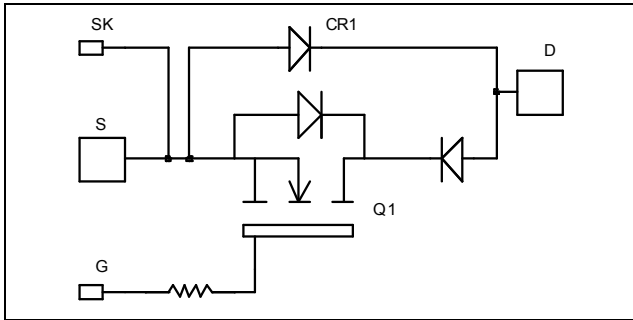

**Application**

- Motor control
- Switched Mode Power Supplies
- Uninterruptible Power Supplies

**Features**

- Power MOS 7<sup>®</sup> MOSFETs
  - Low  $R_{DSon}$
  - Low input and Miller capacitance
  - Low gate charge
  - Avalanche energy rated
  - Very rugged
- Kelvin source for easy drive
- Low stray inductance
  - M6 power connectors
  - M4 signal connectors
- High level of integration

**Benefits**

- Outstanding performance at high frequency operation
- Direct mounting to heatsink (isolated package)
- Low junction to case thermal resistance

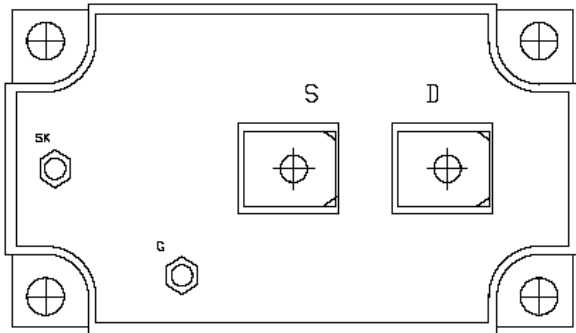

**Absolute maximum ratings**

Symbol	Parameter	Max ratings	Unit
$V_{DSS}$	Drain - Source Breakdown Voltage	200	V
$I_D$	Continuous Drain Current	$T_c = 25^\circ C$	317
		$T_c = 80^\circ C$	237
$I_{DM}$	Pulsed Drain current	1268	
$V_{GS}$	Gate - Source Voltage	$\pm 30$	V
$R_{DSon}$	Drain - Source ON Resistance	5	$m\Omega$
$P_D$	Maximum Power Dissipation	$T_c = 25^\circ C$	1136
$I_{AR}$	Avalanche current (repetitive and non repetitive)	89	A
$E_{AR}$	Repetitive Avalanche Energy	50	mJ
$E_{AS}$	Single Pulse Avalanche Energy	2500	

**CAUTION:** These Devices are sensitive to Electrostatic Discharge. Proper Handling Procedures Should Be Followed.

All ratings @  $T_j = 25^\circ\text{C}$  unless otherwise specified

## Electrical Characteristics

Symbol	Characteristic	Test Conditions	Min	Typ	Max	Unit
$BV_{DSS}$	Drain - Source Breakdown Voltage	$V_{GS} = 0V, I_D = 500\mu A$	200			V
$I_{DSS}$	Zero Gate Voltage Drain Current	$V_{GS} = 0V, V_{DS} = 200V$   $T_j = 25^\circ\text{C}$			200	$\mu A$
		$V_{GS} = 0V, V_{DS} = 160V$   $T_j = 125^\circ\text{C}$			1000	
$R_{DS(on)}$	Drain - Source on Resistance	$V_{GS} = 10V, I_D = 158.5A$			5	$m\Omega$
$V_{GS(th)}$	Gate Threshold Voltage	$V_{GS} = V_{DS}, I_D = 10mA$	3		5	V
$I_{GSS}$	Gate - Source Leakage Current	$V_{GS} = \pm 30V, V_{DS} = 0V$			$\pm 200$	nA

## Dynamic Characteristics

Symbol	Characteristic	Test Conditions	Min	Typ	Max	Unit
$C_{iss}$	Input Capacitance	$V_{GS} = 0V$ $V_{DS} = 25V$ $f = 1MHz$		27.4		nF
$C_{oss}$	Output Capacitance			8.7		
$C_{rss}$	Reverse Transfer Capacitance			0.4		
$Q_g$	Total gate Charge	$V_{GS} = 10V$ $V_{Bus} = 100V$ $I_D = 300A$		448		nC
$Q_{gs}$	Gate - Source Charge			172		
$Q_{gd}$	Gate - Drain Charge			188		
$T_{d(on)}$	Turn-on Delay Time	<b>Inductive switching @ 125°C</b> $V_{GS} = 15V$ $V_{Bus} = 133V$ $I_D = 300A$ $R_G = 1.2\Omega$		28		ns
$T_r$	Rise Time			56		
$T_{d(off)}$	Turn-off Delay Time			81		
$T_f$	Fall Time			99		
$E_{on}$	Turn-on Switching Energy ①	<b>Inductive switching @ 25°C</b> $V_{GS} = 15V, V_{Bus} = 133V$ $I_D = 300A, R_G = 1.2\Omega$		1852		$\mu J$
$E_{off}$	Turn-off Switching Energy ②			1820		
$E_{on}$	Turn-on Switching Energy ①	<b>Inductive switching @ 125°C</b> $V_{GS} = 15V, V_{Bus} = 133V$ $I_D = 300A, R_G = 1.2\Omega$		2432		$\mu J$
$E_{off}$	Turn-off Switching Energy ②			2124		

①  $E_{on}$  includes diode reverse recovery.

② In accordance with JEDEC standard JESD24-1.

## Series diode ratings and characteristics

Symbol	Characteristic	Test Conditions	Min	Typ	Max	Unit
$I_{F(AV)}$	Maximum Average Forward Current	50% duty cycle   $T_c = 85^\circ\text{C}$		120		A
$V_F$	Diode Forward Voltage	$I_F = 120A$		1.1	1.15	V
		$I_F = 240A$		1.4		
		$I_F = 120A$   $T_j = 125^\circ\text{C}$		0.9		
$t_{rr}$	Reverse Recovery Time	$I_F = 120A$ $V_R = 133V$ $di/dt = 400A/\mu s$	$T_j = 25^\circ\text{C}$		31	ns
			$T_j = 125^\circ\text{C}$		60	
$Q_{rr}$	Reverse Recovery Charge	$I_F = 120A$ $V_R = 133V$ $di/dt = 400A/\mu s$	$T_j = 25^\circ\text{C}$		120	nC
			$T_j = 125^\circ\text{C}$		500	

**Parallel diode ratings and characteristics**

<i>Symbol</i>	<i>Characteristic</i>	<i>Test Conditions</i>		<i>Min</i>	<i>Typ</i>	<i>Max</i>	<i>Unit</i>
$I_{F(AV)}$	Maximum Average Forward Current	50% duty cycle	$T_c = 90^\circ\text{C}$		100		A
$V_F$	Diode Forward Voltage	$I_F = 100\text{A}$			1	1.1	V
		$I_F = 200\text{A}$			1.4		
		$I_F = 100\text{A}$	$T_j = 125^\circ\text{C}$		0.9		
$t_{rr}$	Reverse Recovery Time	$I_F = 100\text{A}$	$T_j = 25^\circ\text{C}$		60		ns
		$V_R = 133\text{V}$ $di/dt = 200\text{A}/\mu\text{s}$	$T_j = 125^\circ\text{C}$		110		
$Q_{rr}$	Reverse Recovery Charge	$I_F = 100\text{A}$	$T_j = 25^\circ\text{C}$		200		nC
		$V_R = 133\text{V}$ $di/dt = 200\text{A}/\mu\text{s}$	$T_j = 125^\circ\text{C}$		840		

**Thermal and package characteristics**

<i>Symbol</i>	<i>Characteristic</i>		<i>Min</i>	<i>Typ</i>	<i>Max</i>	<i>Unit</i>
$R_{thJC}$	Junction to Case	Transistor			0.11	$^\circ\text{C}/\text{W}$
		Series diode			0.46	
		Parallel diode			0.6	
$V_{ISOL}$	RMS Isolation Voltage, any terminal to case $t = 1\text{ min}$ , $I_{isol} < 1\text{mA}$ , 50/60Hz		2500			V
$T_J$	Operating junction temperature range		-40		150	$^\circ\text{C}$
$T_{STG}$	Storage Temperature Range		-40		125	
$T_C$	Operating Case Temperature		-40		100	
Torque	Mounting torque	M4			1.2	N.m
		M6	3		5	
Wt	Package Weight				400	g

## Package outline

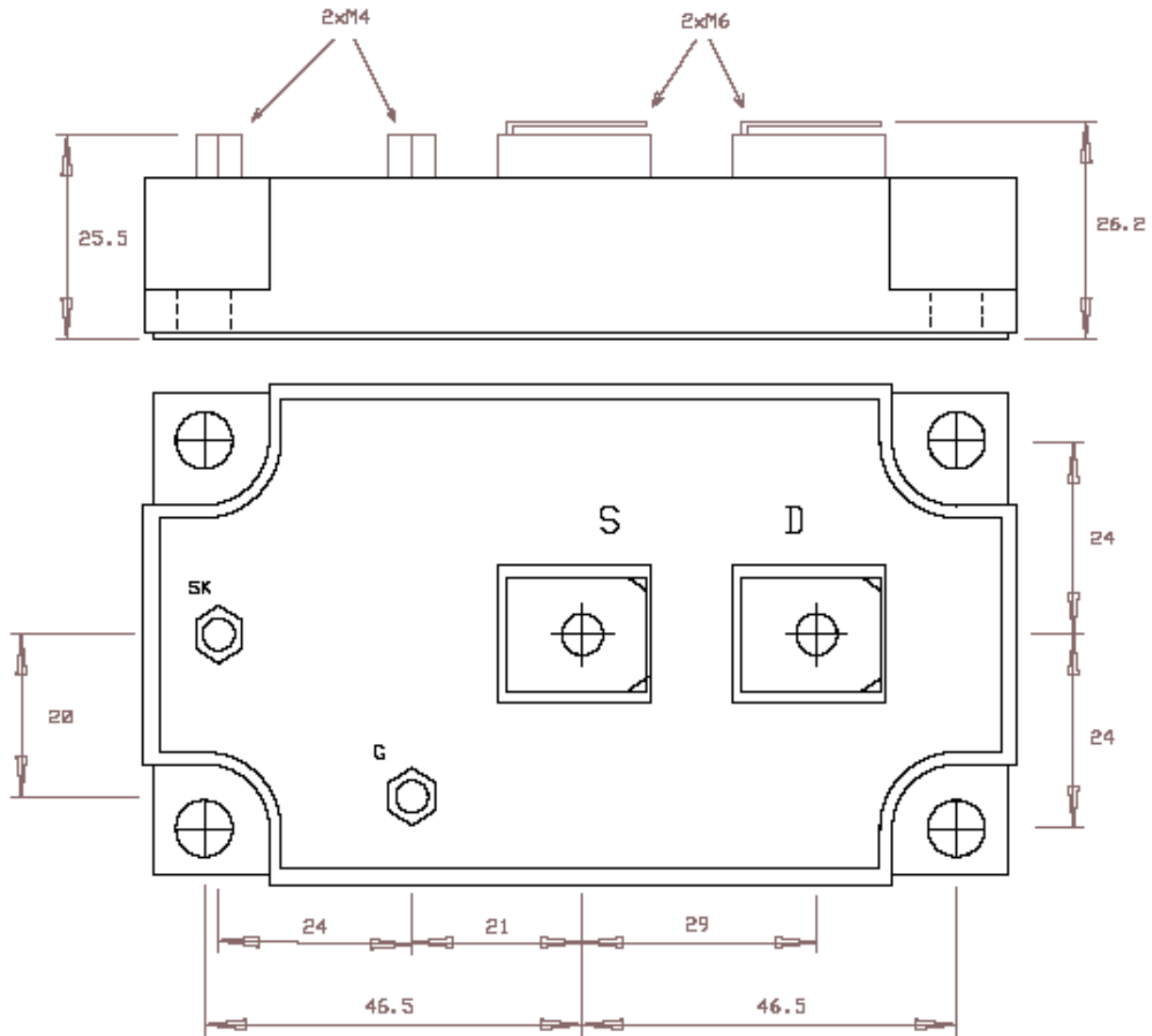

GENERAL TOLERANCES :  $\pm 0.5$ mm

**Mounting holes: 4x $\varnothing 6.5$  mm**

**Typical Performance Curve**

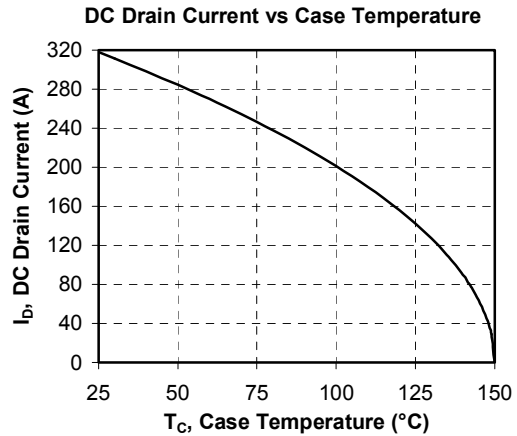
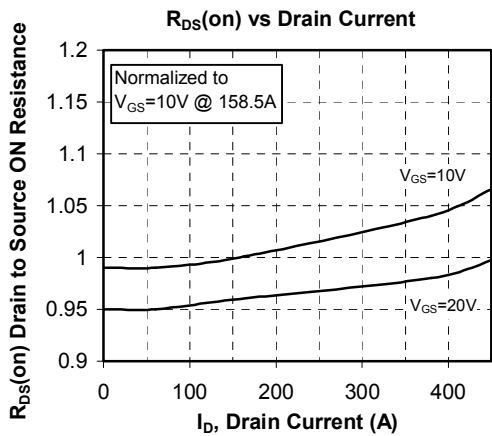
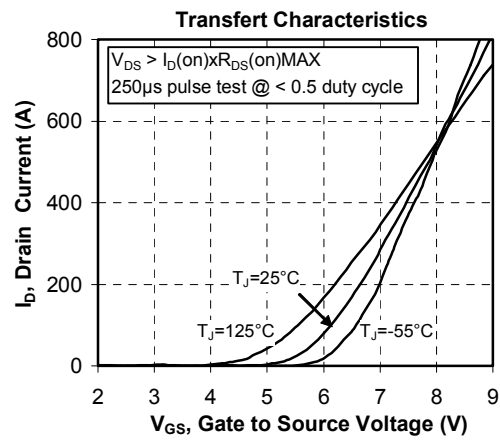
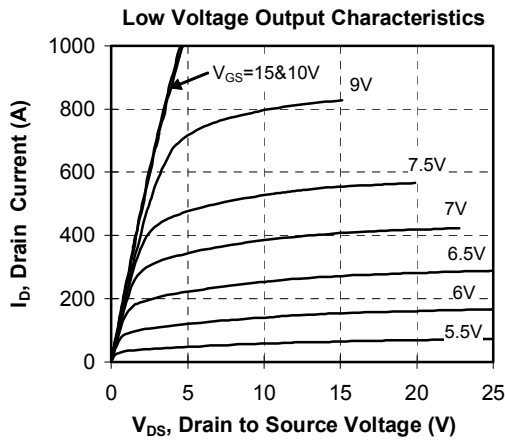
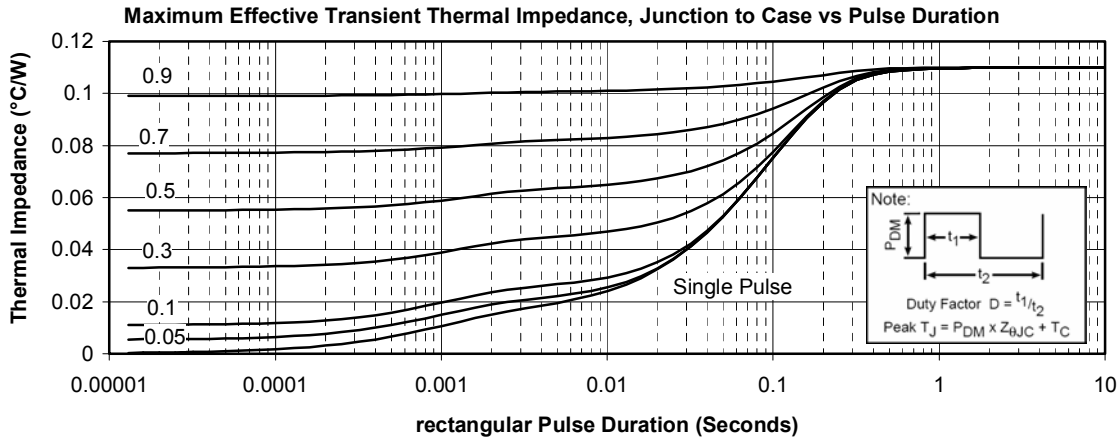

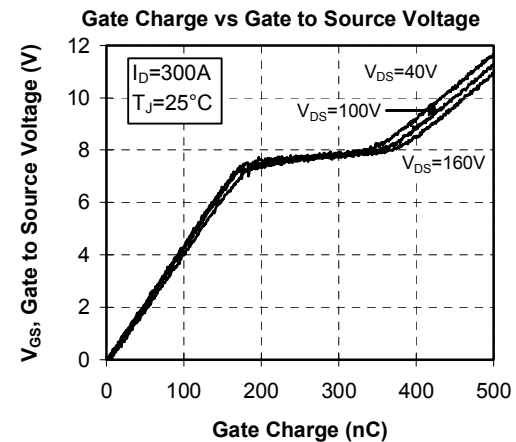
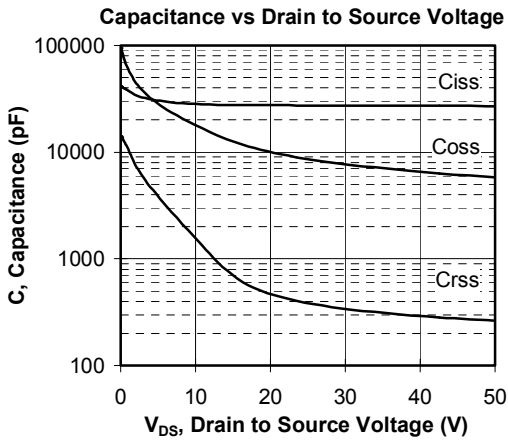
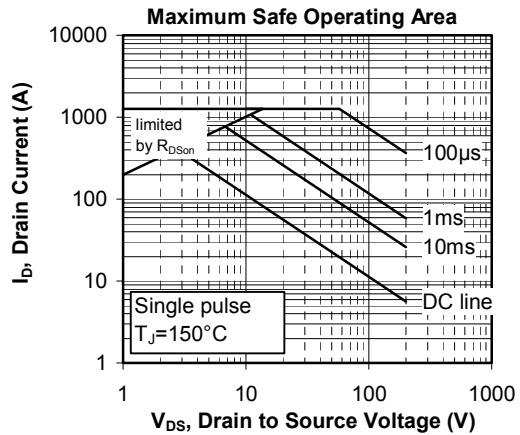
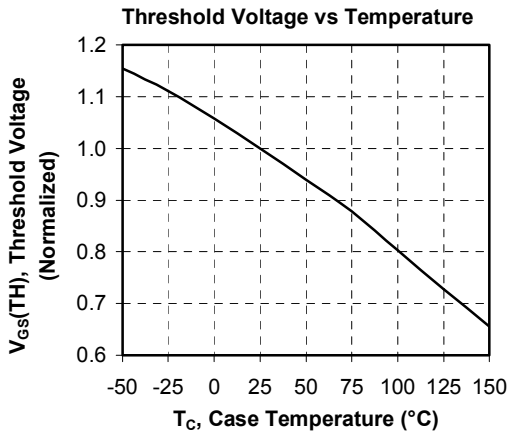
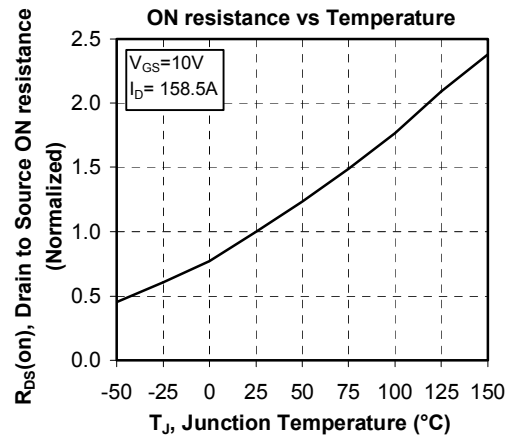
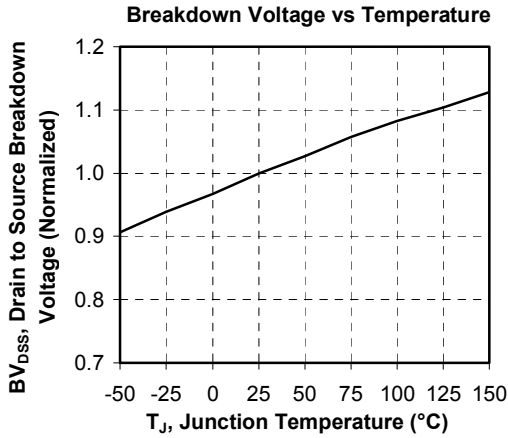

**Delay Times vs Current**

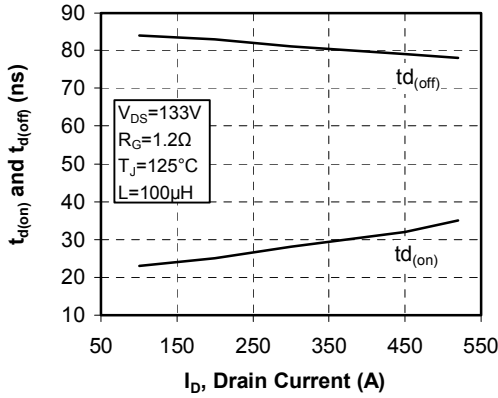

**Rise and Fall times vs Current**

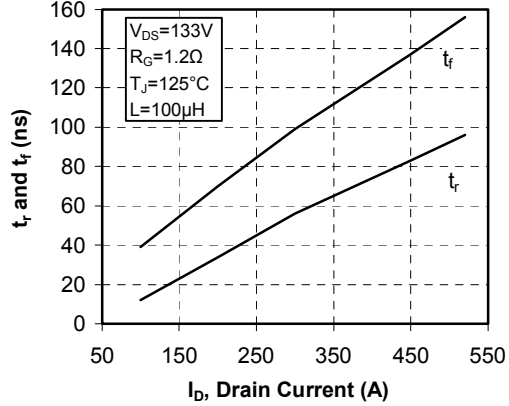

**Switching Energy vs Current**

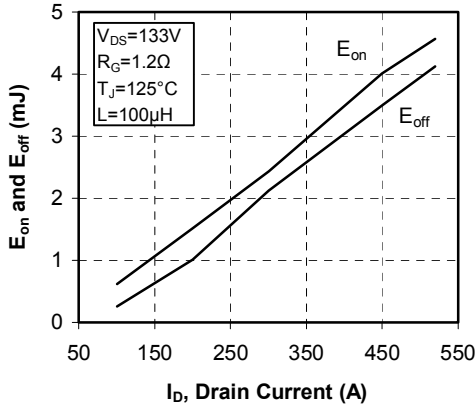

**Switching Energy vs Gate Resistance**

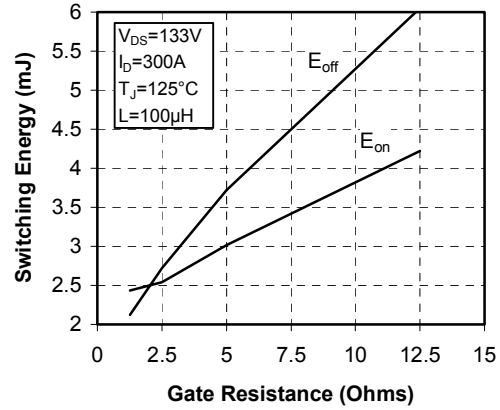

**Operating Frequency vs Drain Current**

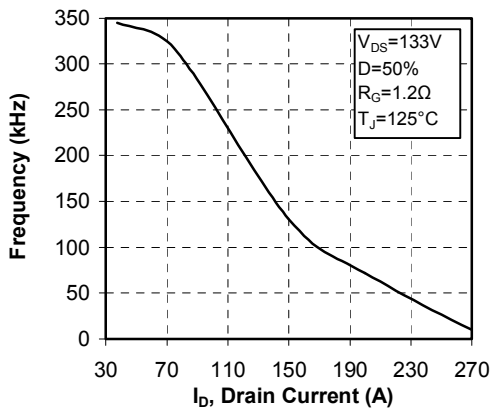

**Source to Drain Diode Forward Voltage**

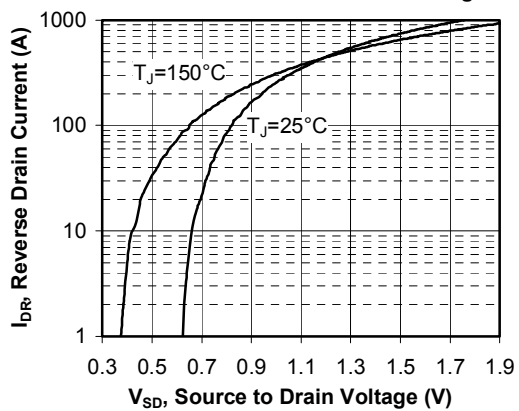

APT reserves the right to change, without notice, the specifications and information contained herein

APT's products are covered by one or more of U.S. patents 4,895,810 5,045,903 5,089,434 5,182,234 5,019,522 5,262,336 6,503,786 5,256,583 4,748,103 5,283,202 5,231,474 5,434,095 5,528,058 and foreign patents. U.S. and Foreign patents pending. All Rights Reserved.