

Dual Enhancement Mode MOSFET (N-and P-Channel)

Features

- N-Channel
30V/5A,
 $R_{DS(ON)} = 35m\Omega(\text{typ.}) @ V_{GS} = 10V$
 $R_{DS(ON)} = 45m\Omega(\text{typ.}) @ V_{GS} = 4.5V$
- P-Channel
-30V/-5A,
 $R_{DS(ON)} = 40m\Omega(\text{typ.}) @ V_{GS} = -10V$
 $R_{DS(ON)} = 55m\Omega(\text{typ.}) @ V_{GS} = -4.5V$
- Super High Dense Cell Design
- Reliable and Rugged
- Lead Free Available (RoHS Compliant)

Applications

- Power Management in Notebook Computer,
Portable Equipment and Battery Powered
Systems

Pin Description

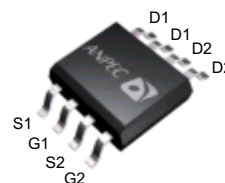

Top View of SOP – 8

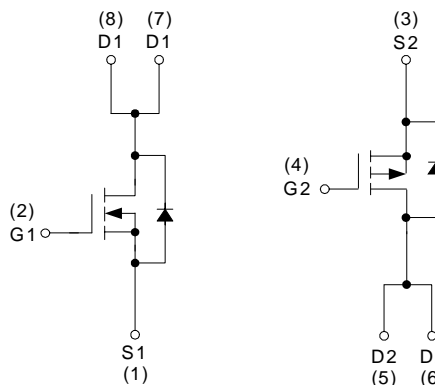

N-Channel MOSFET P-Channel MOSFET

Ordering and Marking Information

| | |
|---|---|
| <p>APM4536 □□-□□□</p> <p style="margin-left: 40px;"> □□□ Lead Free Code □□ Handling Code □ Temp. Range □ Package Code </p> | <p>Package Code K : SOP-8</p> <p>Operating Junction Temp. Range C : -55 to 150°C</p> <p>Handling Code TU : Tube TR : Tape & Reel</p> <p>Lead Free Code L : Lead Free Device Blank : Original Device</p> |
| <p>APM4536 K : APM4536 XXXXX</p> | <p>XXXXX - Date Code</p> |

Note: ANPEC lead-free products contain molding compounds/die attach materials and 100% matte in plate termination finish; which are fully compliant with RoHS and compatible with both SnPb and lead-free soldering operations. ANPEC lead-free products meet or exceed the lead-free requirements of IPC/JEDEC J STD-020C for MSL classification at lead-free peak reflow temperature.

ANPEC reserves the right to make changes to improve reliability or manufacturability without notice, and advise customers to obtain the latest version of relevant information to verify before placing orders.

Absolute Maximum Ratings ($T_A = 25^\circ\text{C}$ unless otherwise noted)

| Symbol | Parameter | N Channel | P Channel | Unit |
|-------------------|--|-------------------------|-----------|--------------------|
| V_{DSS} | Drain-Source Voltage | 30 | -30 | V |
| V_{GSS} | Gate-Source Voltage | ± 16 | ± 16 | |
| I_D^* | Continuous Drain Current | 5 | -5 | A |
| I_{DM}^* | Pulsed Drain Current | | | |
| I_S^* | Diode Continuous Forward Current | 1.7 | -1.7 | A |
| T_J | Maximum Junction Temperature | 150 | | $^\circ\text{C}$ |
| T_{STG} | Storage Temperature Range | -55 to 150 | | |
| P_D^* | Power Dissipation | $T_A=25^\circ\text{C}$ | 2 | W |
| | | $T_A=100^\circ\text{C}$ | 0.8 | |
| $R_{\theta JA}^*$ | Thermal Resistance-Junction to Ambient | 62.5 | | $^\circ\text{C/W}$ |

Note:

*Surface Mounted on 1in^2 pad area, $t \leq 10\text{sec}$.

Electrical Characteristics ($T_A = 25^\circ\text{C}$ unless otherwise noted)

| Symbol | Parameter | Test Condition | APM4536K | | | Unit | |
|-------------------------------|----------------------------------|--|----------|------|------|---------------|------------|
| | | | Min. | Typ. | Max. | | |
| Static Characteristics | | | | | | | |
| BV_{DSS} | Drain-Source Breakdown Voltage | $V_{GS}=0\text{V}, I_{DS}=250\mu\text{A}$ | N-Ch | 30 | | V | |
| | | $V_{GS}=0\text{V}, I_{DS}=-250\mu\text{A}$ | P-Ch | -30 | | | |
| I_{DSS} | Zero Gate Voltage Drain Current | $V_{DS}=24\text{V}, V_{GS}=0\text{V}$ $T_J=85^\circ\text{C}$ | N-Ch | | 1 | μA | |
| | | | | | 30 | | |
| | | $V_{DS}=-24\text{V}, V_{GS}=0\text{V}$ $T_J=85^\circ\text{C}$ | P-Ch | | -1 | | |
| | | | | | -30 | | |
| $V_{GS(th)}$ | Gate Threshold Voltage | $V_{DS}=V_{GS}, I_{DS}=250\mu\text{A}$ | N-Ch | 0.7 | 1.1 | 1.5 | V |
| | | $V_{DS}=V_{GS}, I_{DS}=-250\mu\text{A}$ | P-Ch | -1 | -1.5 | -2 | |
| I_{GSS} | Gate Leakage Current | $V_{GS}=\pm 16\text{V}, V_{DS}=0\text{V}$ | N-Ch | | | ± 100 | nA |
| | | | P-Ch | | | ± 100 | |
| $R_{DS(ON)}^a$ | Drain-Source On-State Resistance | $V_{GS}=10\text{V}, I_{DS}=5\text{A}$ | N-Ch | | 35 | 50 | m Ω |
| | | $V_{GS}=-10\text{V}, I_{DS}=-5\text{A}$ | P-Ch | | 40 | 55 | |
| | | $V_{GS}=4.5\text{V}, I_{DS}=4\text{A}$ | N-Ch | | 45 | 60 | |
| | | $V_{GS}=-4.5\text{V}, I_{DS}=-4\text{A}$ | P-Ch | | 55 | 75 | |

Electrical Characteristics (Cont.) ($T_A = 25^\circ\text{C}$ unless otherwise noted)

| Symbol | Parameter | Test Condition | APM4536K | | | Unit | |
|--|------------------------------|---|----------|------|------|------|----------|
| | | | Min. | Typ. | Max. | | |
| Diode Characteristics | | | | | | | |
| V_{SD}^a | Diode Forward Voltage | $I_{SD}=1.7A, V_{GS}=0V$ | N-Ch | | 0.8 | 1.3 | V |
| | | $I_{SD}=-1.7A, V_{GS}=0V$ | P-Ch | | -0.8 | -1.3 | |
| Dynamic Characteristics^b | | | | | | | |
| R_G | Gate Resistance | $V_{GS}=0V, V_{DS}=0V, F=1\text{MHz}$ | N-Ch | | 3 | | Ω |
| | | | P-Ch | | 12 | | |
| C_{iss} | Input Capacitance | N-Channel $V_{GS}=0V,$ $V_{DS}=25V,$ Frequency=1.0MHz | N-Ch | | 360 | | pF |
| | | | P-Ch | | 650 | | |
| C_{oss} | Output Capacitance | P-Channel $V_{GS}=0V,$ $V_{DS}=-25V,$ Frequency=1.0MHz | N-Ch | | 75 | | |
| | | | P-Ch | | 145 | | |
| C_{rss} | Reverse Transfer Capacitance | N-Channel $V_{GS}=0V,$ $V_{DS}=-25V,$ Frequency=1.0MHz | N-Ch | | 35 | | |
| | | | P-Ch | | 80 | | |
| $t_{d(ON)}$ | Turn-on Delay Time | N-Channel $V_{DD}=15V, R_L=15\Omega,$ $I_{DS}=1A, V_{GEN}=10V,$ $R_G=6\Omega$ | N-Ch | | 10 | 15 | ns |
| | | | P-Ch | | 10 | 20 | |
| T_r | Turn-on Rise Time | P-Channel $V_{DD}=-15V, R_L=15\Omega,$ $I_{DS}=-1A, V_{GEN}=-10V,$ $R_G=6\Omega$ | N-Ch | | 8 | 20 | |
| | | | P-Ch | | 15 | 30 | |
| $t_{d(OFF)}$ | Turn-off Delay Time | N-Channel $V_{DD}=15V, R_L=15\Omega,$ $I_{DS}=1A, V_{GEN}=10V,$ $R_G=6\Omega$ | N-Ch | | 20 | 28 | |
| | | | P-Ch | | 25 | 50 | |
| T_f | Turn-off Fall Time | P-Channel $V_{DD}=-15V, R_L=15\Omega,$ $I_{DS}=-1A, V_{GEN}=-10V,$ $R_G=6\Omega$ | N-Ch | | 5 | 15 | |
| | | | P-Ch | | 15 | 30 | |
| Gate Charge Characteristics^b | | | | | | | |
| Q_g | Total Gate Charge | N-Channel $V_{DS}=15V, V_{GS}=10V,$ $I_{DS}=5A$ | N-Ch | | 14.5 | 20 | nC |
| | | | P-Ch | | 26 | 35 | |
| Q_{gs} | Gate-Source Charge | P-Channel $V_{DS}=-15V, V_{GS}=-10V,$ $I_{DS}=-5A$ | N-Ch | | 4.3 | | |
| | | | P-Ch | | 5.1 | | |
| Q_{gd} | Gate-Drain Charge | N-Channel $V_{DS}=15V, V_{GS}=10V,$ $I_{DS}=5A$ | N-Ch | | 2.3 | | |
| | | | P-Ch | | 3.3 | | |

Notes:

- a : Pulse test ; pulse width $\leq 300\mu\text{s}$, duty cycle $\leq 2\%$.
- b : Guaranteed by design, not subject to production testing.

Typical Characteristics

N-Channel

Power Dissipation

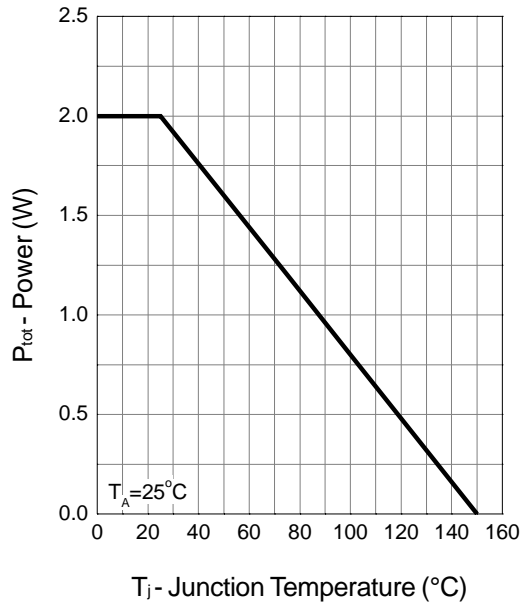

Drain Current

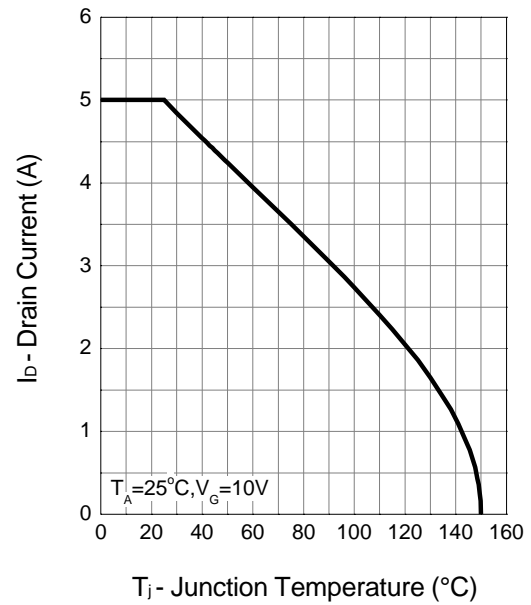

Safe Operation Area

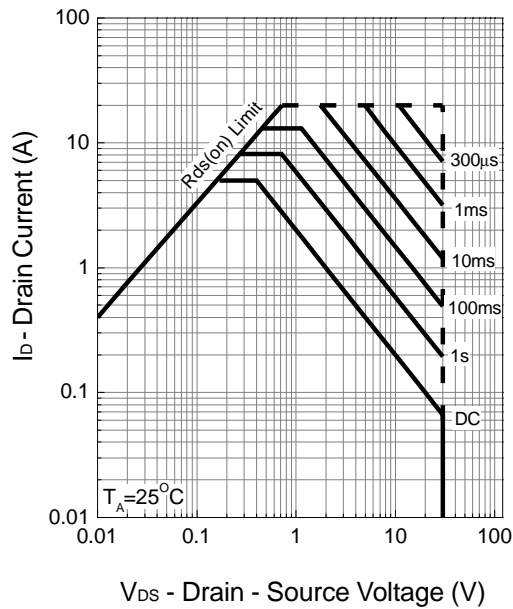

Thermal Transient Impedance

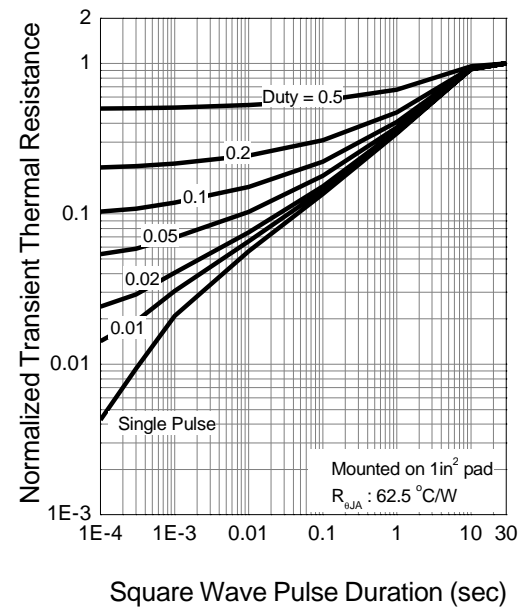

Typical Characteristics (Cont.)

N-Channel

Output Characteristics

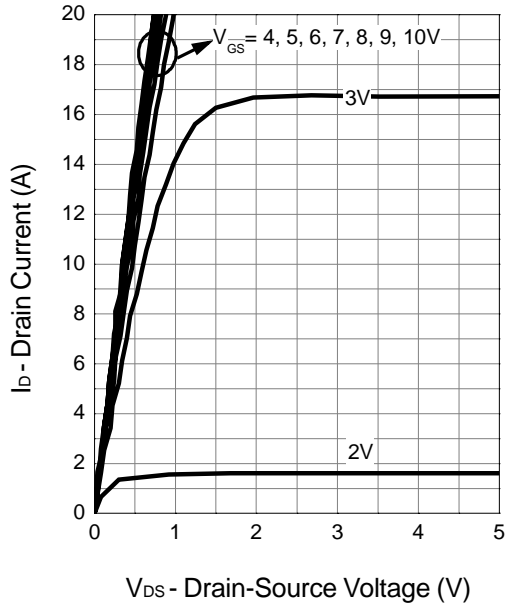

Drain-Source On Resistance

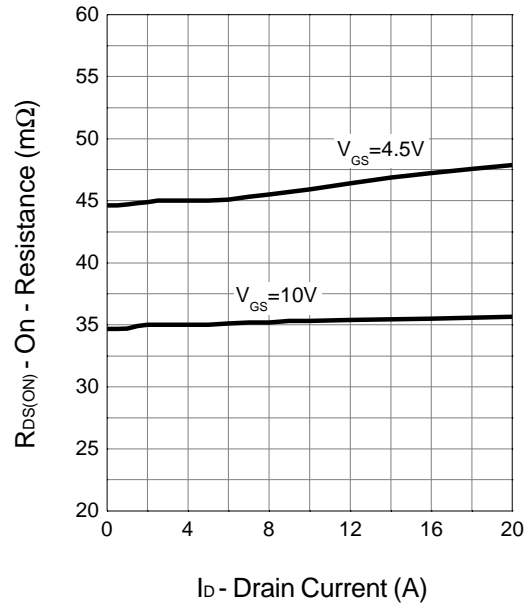

Transfer Characteristics

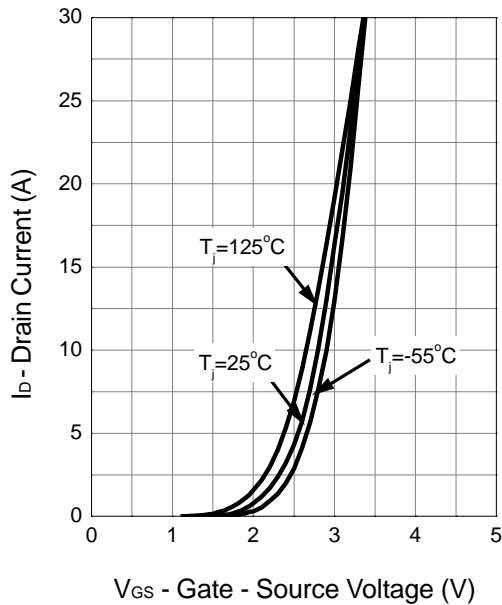

Gate Threshold Voltage

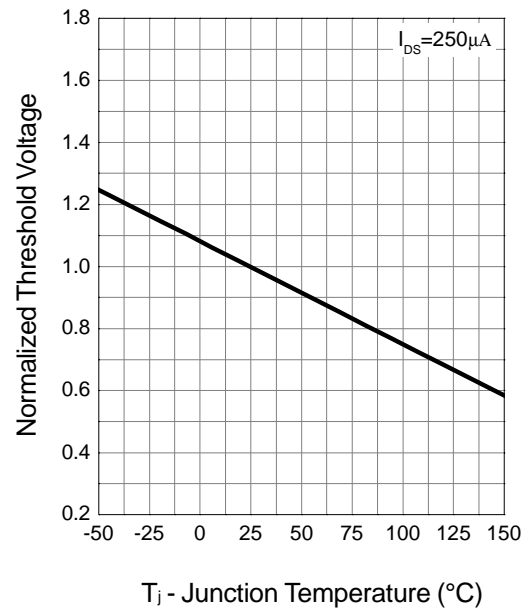

Typical Characteristics (Cont.)

N-Channel

Drain-Source On Resistance

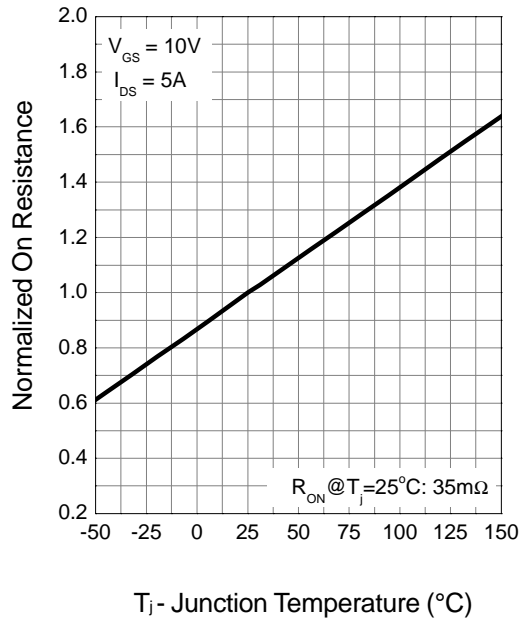

Source-Drain Diode Forward

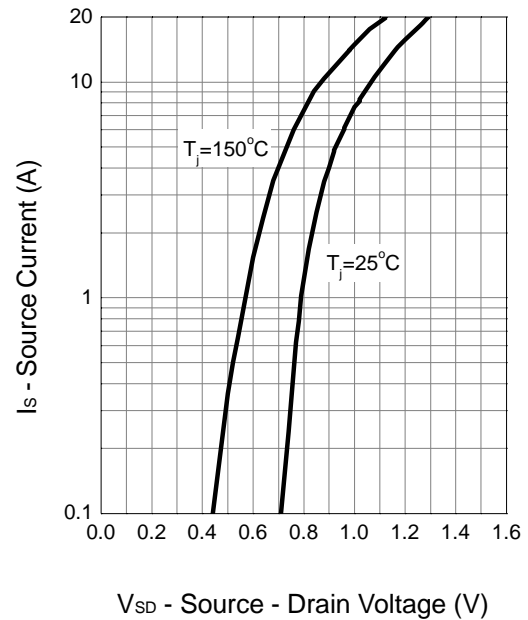

Capacitance

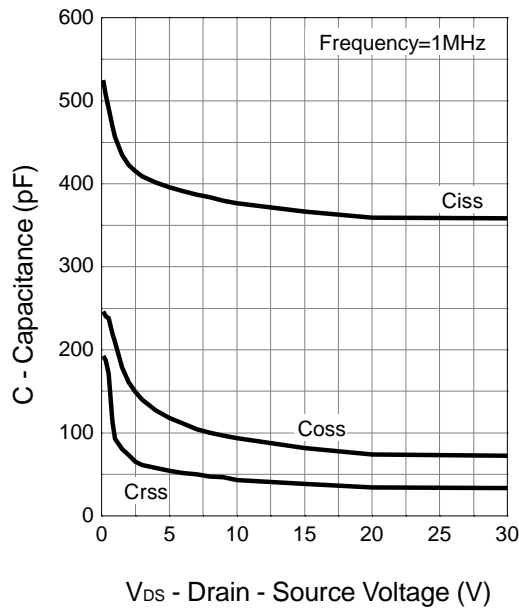

Gate Charge

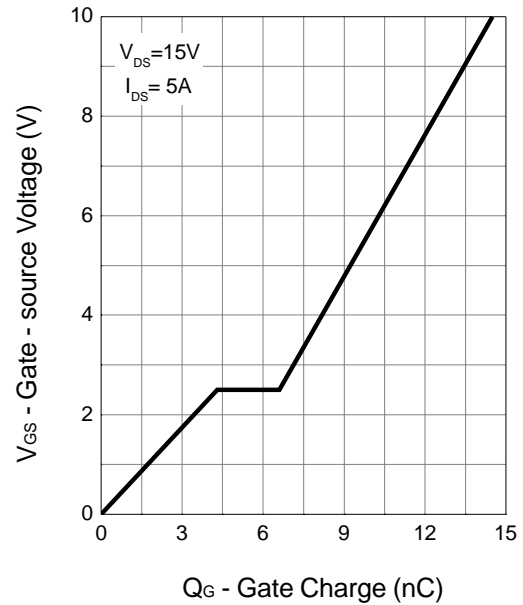

Typical Characteristics (Cont.)

P-Channel

Power Dissipation

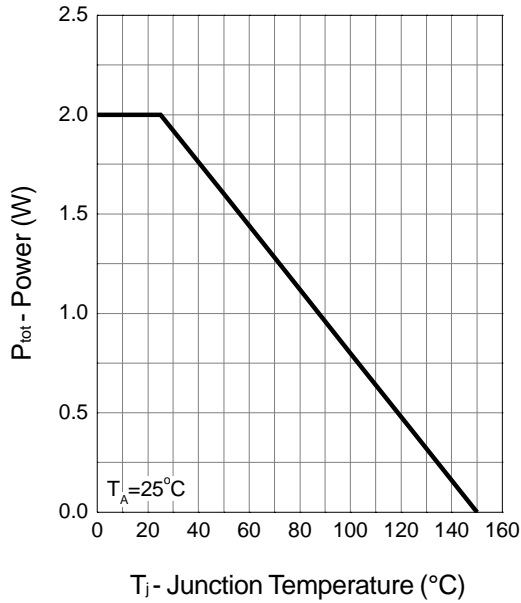

Drain Current

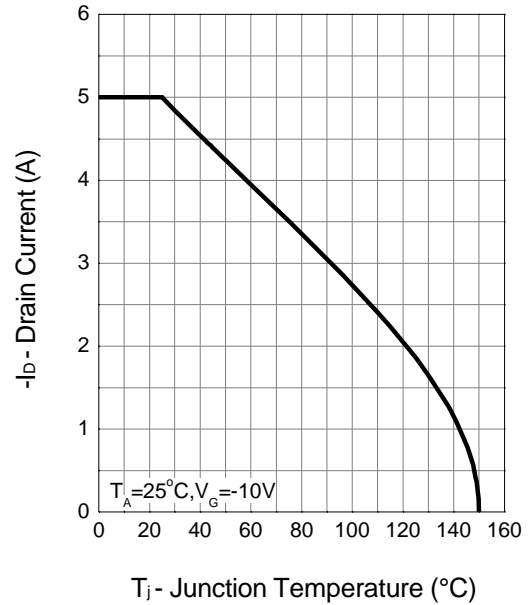

Safe Operation Area

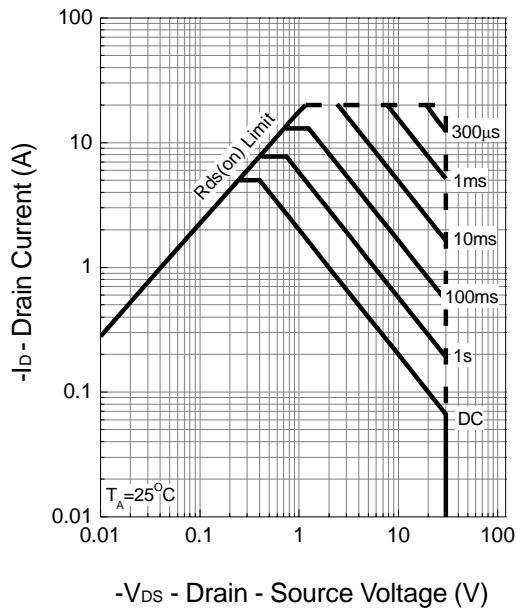

Thermal Transient Impedance

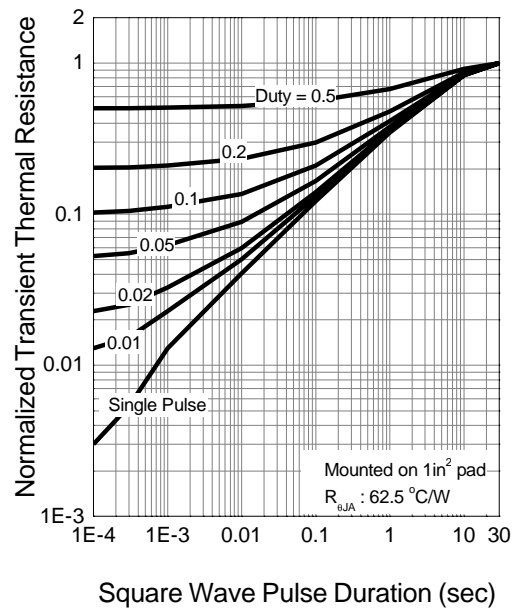

Typical Characteristics (Cont.)

P-Channel

Output Characteristics

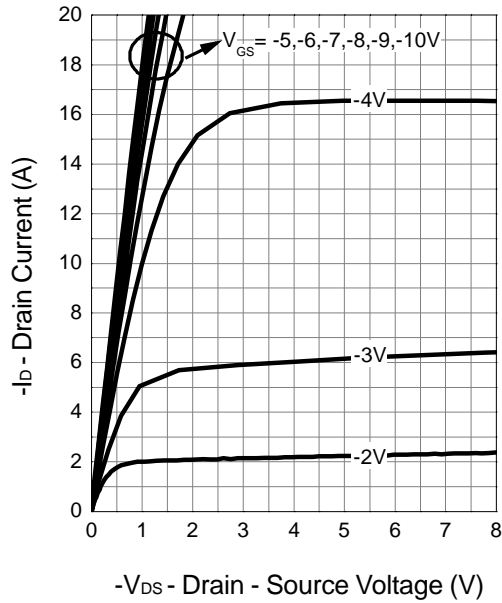

Drain-Source On Resistance

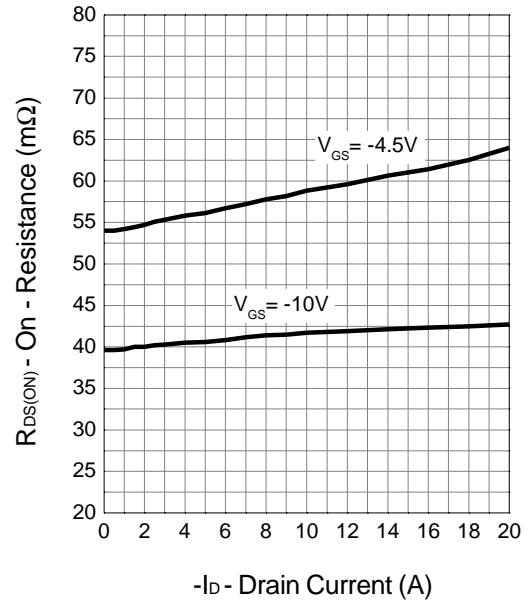

Transfer Characteristics

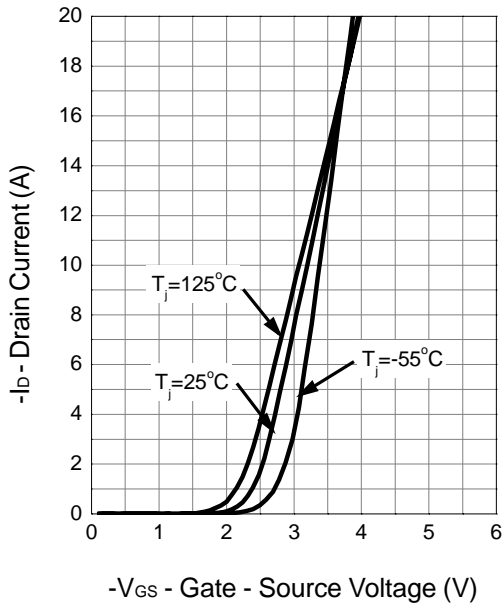

Gate Threshold Voltage

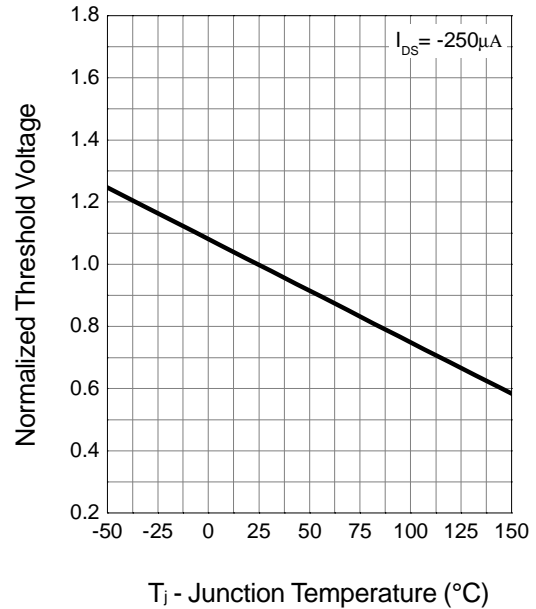

Typical Characteristics (Cont.)

P-Channel

Drain-Source On Resistance

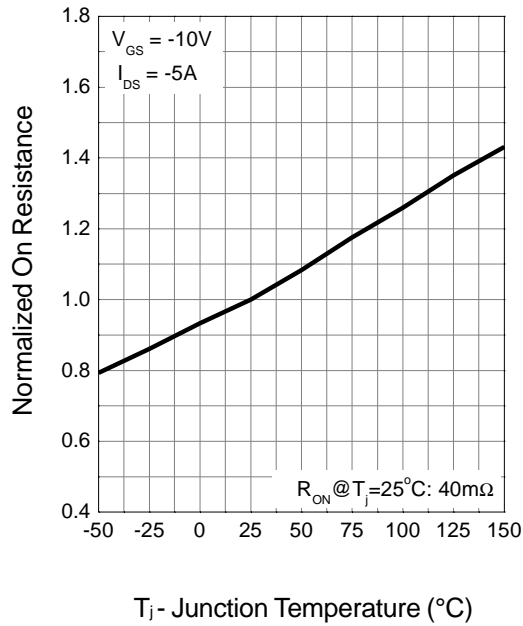

Source-Drain Diode Forward

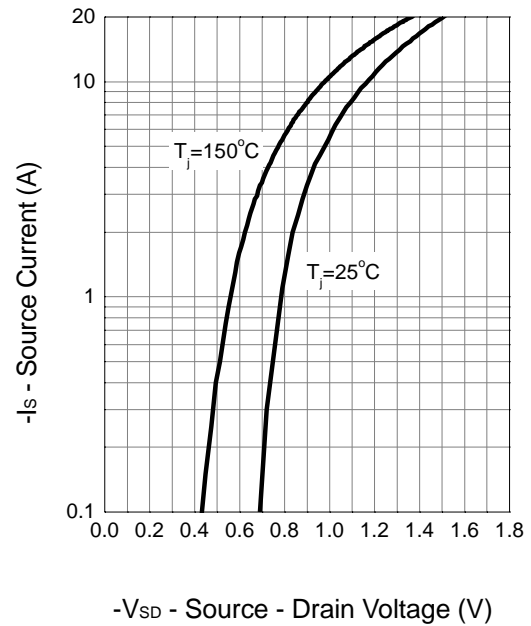

Capacitance

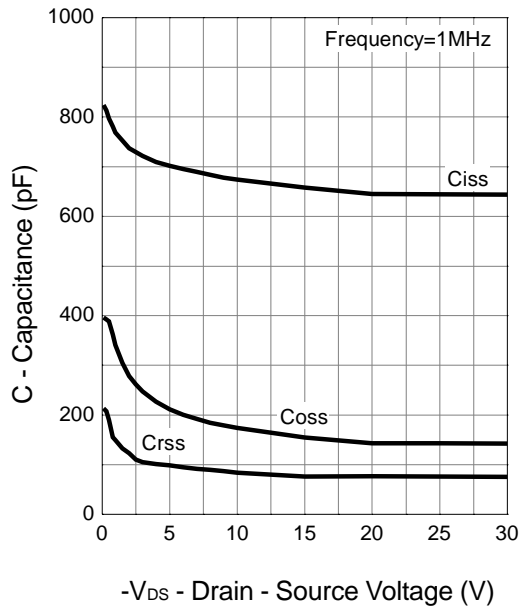

Gate Charge

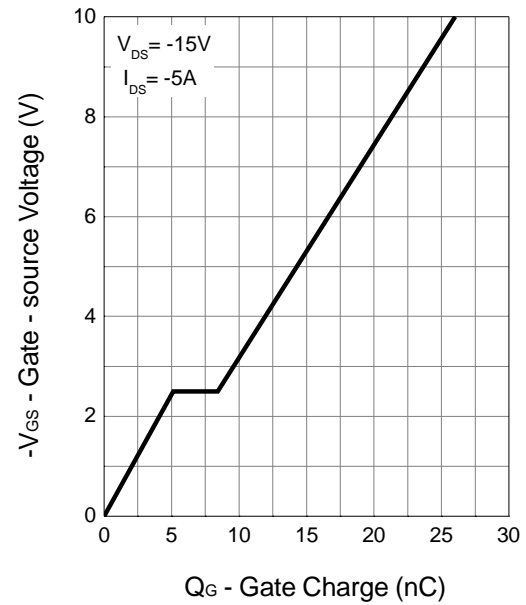

Packaging Information

SOP-8 pin (Reference JEDEC Registration MS-012)

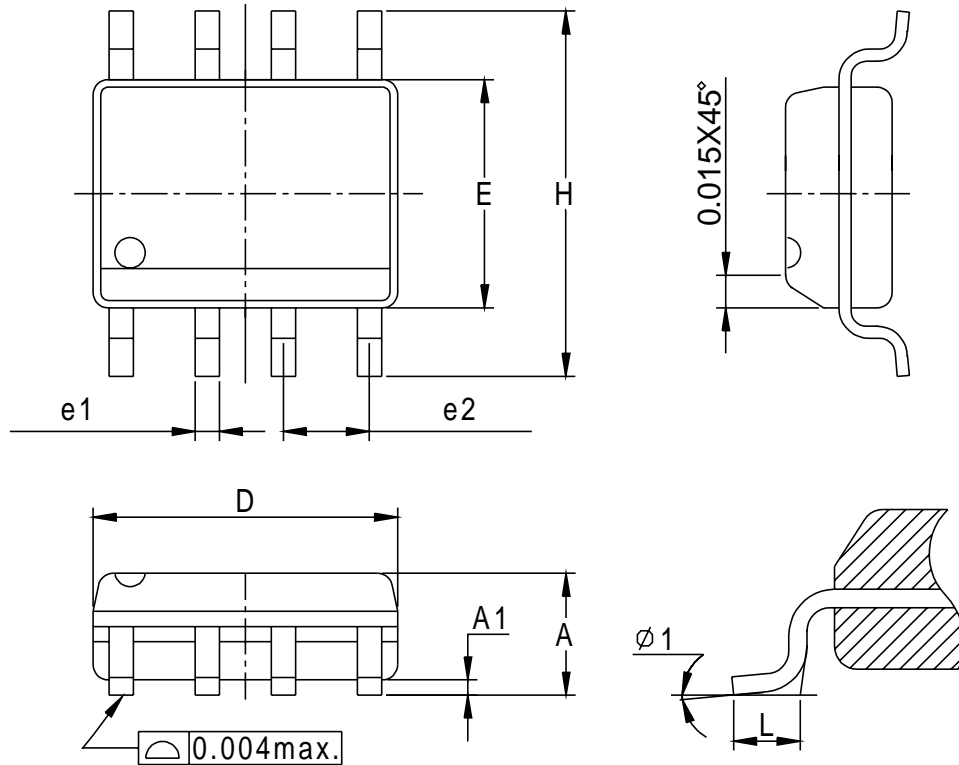

| Dim | Millimeters | | Inches | |
|-----|-------------|------|---------|-------|
| | Min. | Max. | Min. | Max. |
| A | 1.35 | 1.75 | 0.053 | 0.069 |
| A1 | 0.10 | 0.25 | 0.004 | 0.010 |
| D | 4.80 | 5.00 | 0.189 | 0.197 |
| E | 3.80 | 4.00 | 0.150 | 0.157 |
| H | 5.80 | 6.20 | 0.228 | 0.244 |
| L | 0.40 | 1.27 | 0.016 | 0.050 |
| e1 | 0.33 | 0.51 | 0.013 | 0.020 |
| e2 | 1.27BSC | | 0.50BSC | |
| φ 1 | 8° | | 8° | |

Physical Specifications

| | |
|--------------------|--|
| Terminal Material | Solder-Plated Copper (Solder Material : 90/10 or 63/37 SnPb), 100%Sn |
| Lead Solderability | Meets EIA Specification RSI86-91, ANSI/J-STD-002 Category 3. |

Reflow Condition (IR/Convection or VPR Reflow)

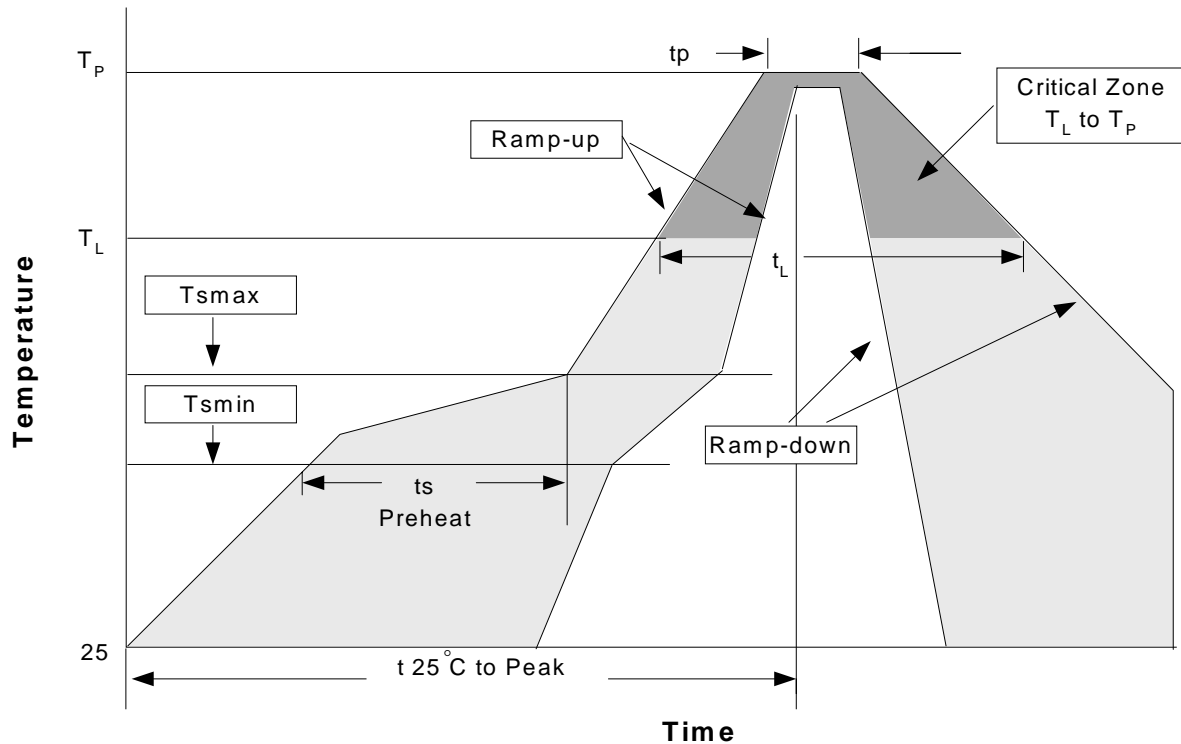

Classification Reflow Profiles

| Profile Feature | Sn-Pb Eutectic Assembly | Pb-Free Assembly |
|--|-------------------------|------------------|
| Average ramp-up rate (T_L to T_P) | 3°C/second max. | 3°C/second max. |
| Preheat | | |
| - Temperature Min (T_{smin}) | 100°C | 150°C |
| - Temperature Max (T_{smax}) | 150°C | 200°C |
| - Time (min to max) (t_s) | 60-120 seconds | 60-180 seconds |
| Time maintained above: | | |
| - Temperature (T_L) | 183°C | 217°C |
| - Time (t_L) | 60-150 seconds | 60-150 seconds |
| Peak/Classification Temperature (T_p) | See table 1 | See table 2 |
| Time within 5°C of actual Peak Temperature (t_p) | 10-30 seconds | 20-40 seconds |
| Ramp-down Rate | 6°C/second max. | 6°C/second max. |
| Time 25°C to Peak Temperature | 6 minutes max. | 8 minutes max. |

Notes: All temperatures refer to topside of the package .Measured on the body surface.

Classification Reflow Profiles(Cont.)

Table 1. SnPb Eutectic Process – Package Peak Reflow Temperatures

| Package Thickness | Volume mm ³ <350 | Volume mm ³ ≥350 |
|-------------------|--------------------------------|--------------------------------|
| <2.5 mm | 240 +0/-5°C | 225 +0/-5°C |
| ≥2.5 mm | 225 +0/-5°C | 225 +0/-5°C |

Table 2. Pb-free Process – Package Classification Reflow Temperatures

| Package Thickness | Volume mm ³ <350 | Volume mm ³ 350-2000 | Volume mm ³ >2000 |
|-------------------|--------------------------------|------------------------------------|---------------------------------|
| <1.6 mm | 260 +0°C* | 260 +0°C* | 260 +0°C* |
| 1.6 mm – 2.5 mm | 260 +0°C* | 250 +0°C* | 245 +0°C* |
| ≥2.5 mm | 250 +0°C* | 245 +0°C* | 245 +0°C* |

*Tolerance: The device manufacturer/supplier **shall** assure process compatibility up to and including the stated classification temperature (this means Peak reflow temperature +0°C. For example 260°C+0°C) at the rated MSL level.

Reliability Test Program

| Test item | Method | Description |
|---------------|---------------------|---------------------------|
| SOLDERABILITY | MIL-STD-883D-2003 | 245°C, 5 SEC |
| HOLT | MIL-STD 883D-1005.7 | 1000 Hrs Bias @ 125°C |
| PCT | JESD-22-B, A102 | 168 Hrs, 100% RH, 121°C |
| TST | MIL-STD 883D-1011.9 | -65°C ~ 150°C, 200 Cycles |

Carrier Tape & Reel Dimensions

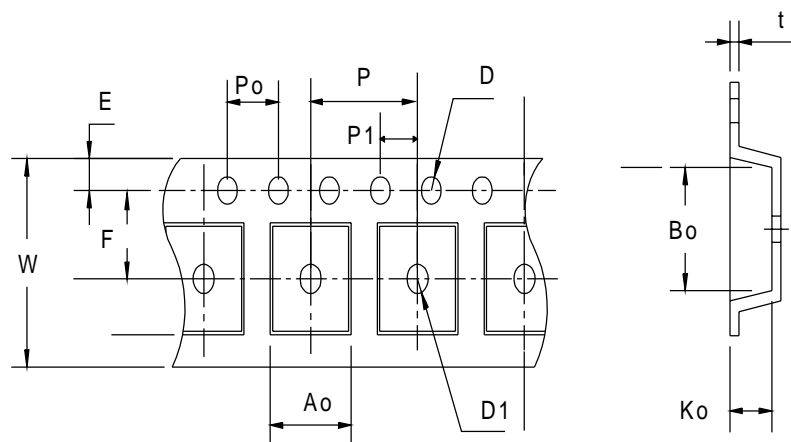

Carrier Tape & Reel Dimensions(Cont.)

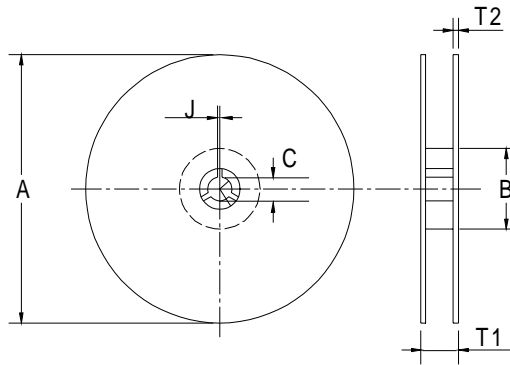

| Application | A | B | C | J | T1 | T2 | W | P | E |
|-------------|-----------|----------|--------------|-----------|-----------|-----------|----------------|----------|-----------|
| SOP-8 | 330±1 | 62 ± 1.5 | 12.75 + 0.15 | 2 + 0.5 | 12.4 +0.2 | 2± 0.2 | 12 + 0.3 - 0.1 | 8± 0.1 | 1.75± 0.1 |
| | F | D | D1 | Po | P1 | Ao | Bo | Ko | t |
| | 5.5 ± 0.1 | 1.55±0.1 | 1.55+ 0.25 | 4.0 ± 0.1 | 2.0 ± 0.1 | 6.4 ± 0.1 | 5.2± 0.1 | 2.1± 0.1 | 0.3±0.013 |

(mm)

Cover Tape Dimensions

| Application | Carrier Width | Cover Tape Width | Devices Per Reel |
|-------------|---------------|------------------|------------------|
| SOP- 8 | 12 | 9.3 | 2500 |

Customer Service

Anpec Electronics Corp.

Head Office :

5F, No. 2 Li-Hsin Road, SBIP,

Hsin-Chu, Taiwan, R.O.C.

Tel : 886-3-5642000

Fax : 886-3-5642050

Taipei Branch :

7F, No. 137, Lane 235, Pac Chiao Rd.,

Hsin Tien City, Taipei Hsien, Taiwan, R. O. C.

Tel : 886-2-89191368

Fax : 886-2-89191369