

2.00mm (0.079") PITCH CONNECTOR



**Board-to-Board
Wafer**

20045WS Series

DIP

Straight

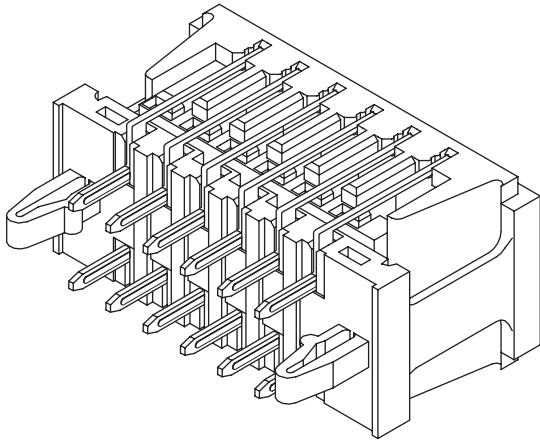

Material

I/NO	DESCRIPTION	TITLE	MATERIAL
1	WAFER	20045WS	PA66, UL 94V Grade
2	PIN	20045PS	Phosphor Bronze & Tin-Plated

Available Pin

PARTS NO.	A	B	C	D
20045 WS-08A00	13.4	9.1	6.0	10.4
20045 WS-10A00	15.4	11.1	8.0	12.4
20045 WS-12A00	17.4	13.1	10.0	14.4

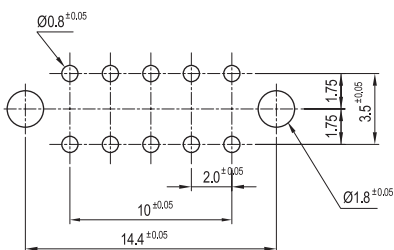
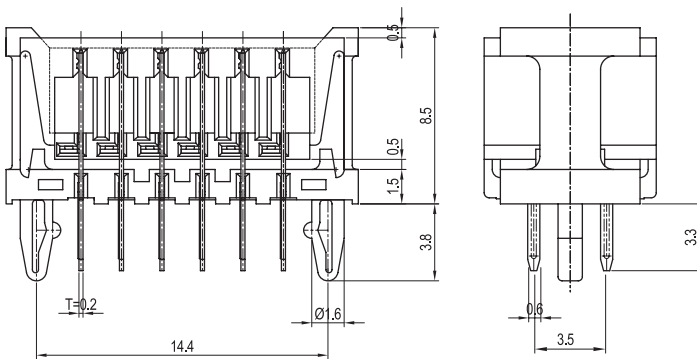
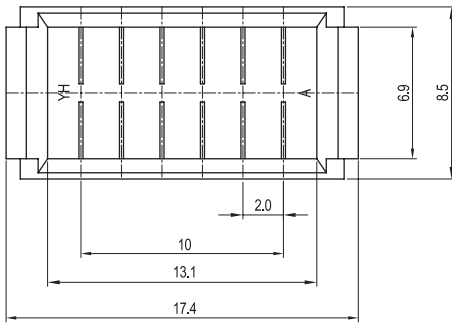

P,C,B LAYOUT

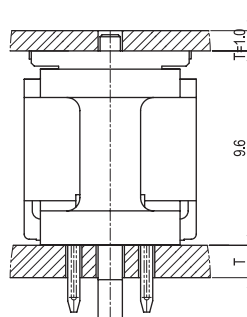

MATING WITH

Specification

ITEM	SPEC
Voltage Rating	AC/DC 250V
Current Rating	AC/DC 1A
Operating Temperature	-25°C~+85°C
Contact Resistance	30mΩ MAX
Withstanding Voltage	AC500V/1min
Insulation Resistance	1000MΩ MIN
Applicable Wire	-
Applicable P.C.B	1.2~1.6mm
Applicable FPC/FFC	-
Solder Height	-
Crimp Tensile Strength	-
UL FILE NO	-