

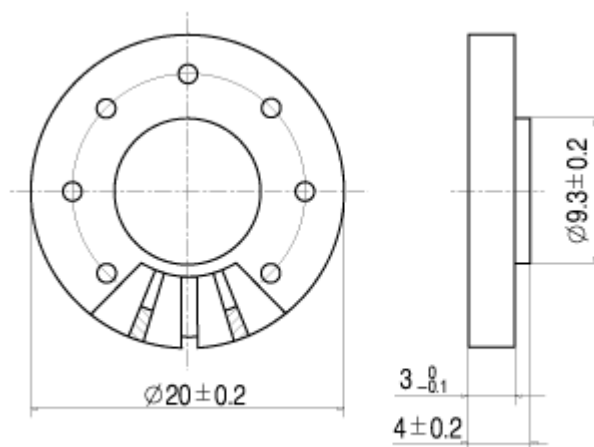

Type	BMS-2011
Rated Impedance( $\Omega$ )	$32 \pm 15\%$
Rated(Max.) Power(W)	0.1(0.2)
Resonant Frequency(Hz)	$1000 \pm 20\%$
Rated Freq.Range(Hz)	$f_0 \sim 3500$
Sound Pressure Level(dB)	$72 \pm 3$
Magnet(g)	0.6
Operating Temperature( $^{\circ}\text{C}$ )	$-10 \sim +40$



Unit:mm

