

# 3M™ Mini D Ribbon (MDR) Connectors

.050" I/O Mounting Hardware — Jacksockets

3341-XX Series

3M Part Number  
3341-10

Material: ST. Steel  
Plating: Passivated  
Thread Size: M2.5/M2.5, 2.5 inch/lbs.  
Package Size: 200 Pieces

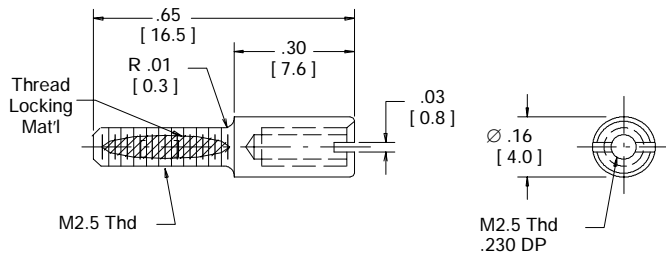

3M Part Number  
3341-16

Material: ST. Steel  
Plating: Passivated  
Thread Size: #4-40/#4-40, 3.5 inch/lbs.  
Package Size: 200 Pieces

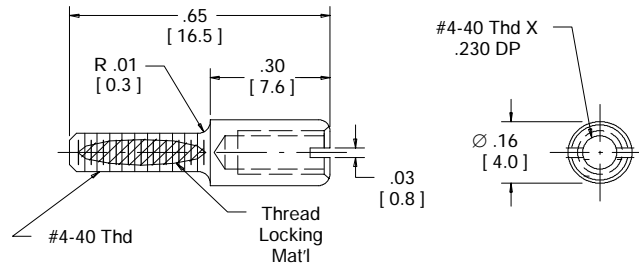

3M Part Number  
3341-17

Material: ST. Steel  
Plating: Passivated  
Thread Size: #4-40/#4-40, 3.5 inch/lbs.  
Package Size: 200 Pieces

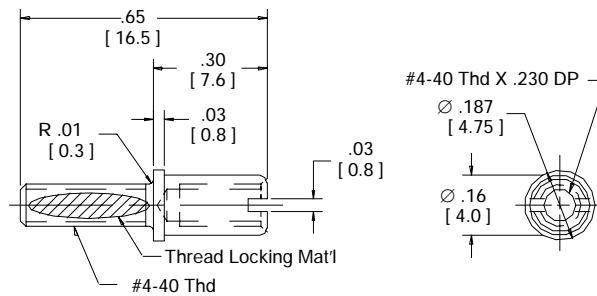

3M Part Number  
3341-13

Material: ST. Steel  
Plating: Passivated  
Thread Size: M2.5/#4-40, 2.5 inch/lbs.  
Package Size: 200 Pieces

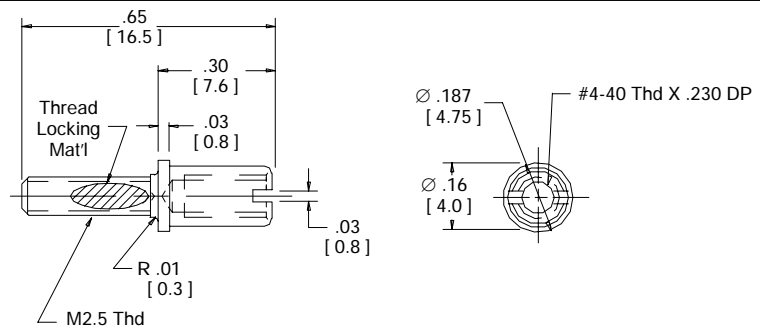

3M Part Number  
3341-25

Material: ST. Steel  
Plating: Passivated  
Thread Size: M2.5/M2, 2.5 inch/lbs.  
Package Size: 200 Pieces

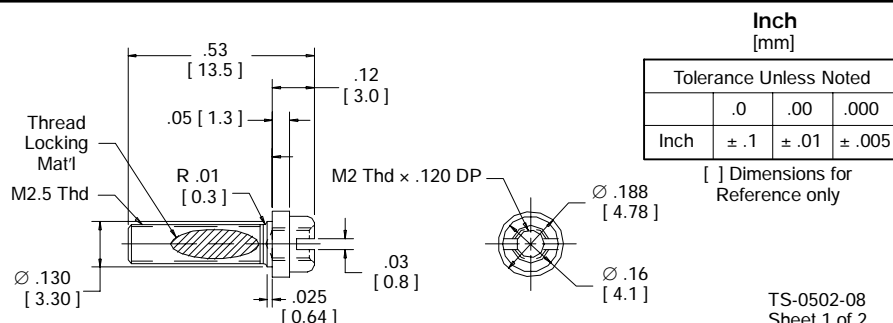

TS-0502-08  
Sheet 1 of 2

# 3M™ Mini D Ribbon (MDR) Connectors

## .050" I/O Mounting Hardware — Jacksockets

3341-XX Series

3M Part Number  
3341-31

Material: ST. Steel  
 Plating: Passivated  
 Thread Size: M2.5/#4-40, 2.5 inch/lbs.  
 Package Size: 200 Pieces

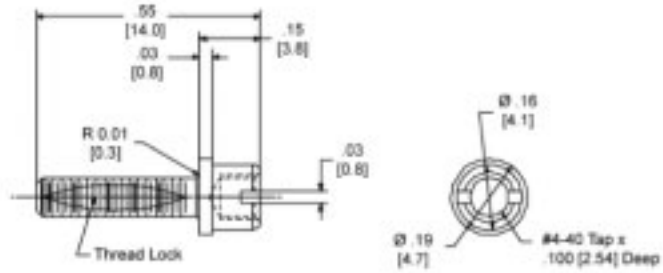

3M Part Number  
3341-32

Material: ST. Steel  
 Plating: Passivated  
 Thread Size: M2.5/#4-40, 2.5 inch/lbs.  
 Package Size: 200 Pieces

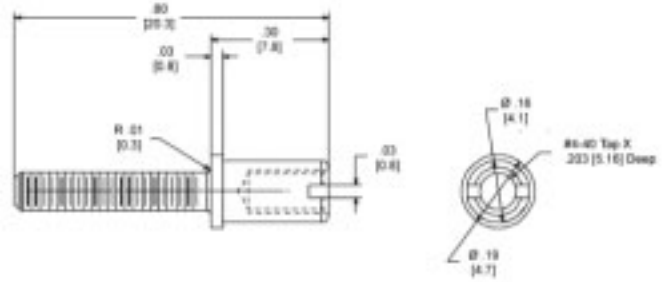

TS-0502-08  
 Sheet 2 of 2

### **Important Notice**

All statements, technical information, and recommendations related to 3M's products are based on information believed to be reliable, but the accuracy or completeness is not guaranteed. Before using this product, you must evaluate it and determine if it is suitable for your intended application. You assume all risks and liability associated with such use. Any statements related to the product which are not contained in 3M's current publications, or any contrary statements contained on your purchase order shall have no force or effect unless expressly agreed upon, in writing, by an authorized officer of 3M.



### **Electronic and Interconnect Solutions Division**

6801 River Place Blvd.  
Austin, TX 78726-9000  
[www.3M.com/eisd](http://www.3M.com/eisd)

### **Warranty; Limited Remedy; Limited Liability.**

This product will be free from defects in material and manufacture for a period of 1 year from the date of purchase. **3M MAKES NO OTHER WARRANTIES INCLUDING, BUT NOT LIMITED TO, ANY IMPLIED WARRANTY OF MERCHANTABILITY OR FITNESS FOR A PARTICULAR PURPOSE.** If this product is defective within the warranty period stated above, your exclusive remedy shall be, at 3M's option, to replace or repair the 3M product or refund the purchase price of the 3M product. **Except where prohibited by law, 3M will not be liable for any loss or damage arising from this 3M product, whether direct, indirect, special, incidental or consequential regardless of the legal theory asserted.**