

4.20mm (0.165") PITCH CONNECTOR



Wire-to-Board
Wafer

SMAW420 Series

DIP

Right Angle

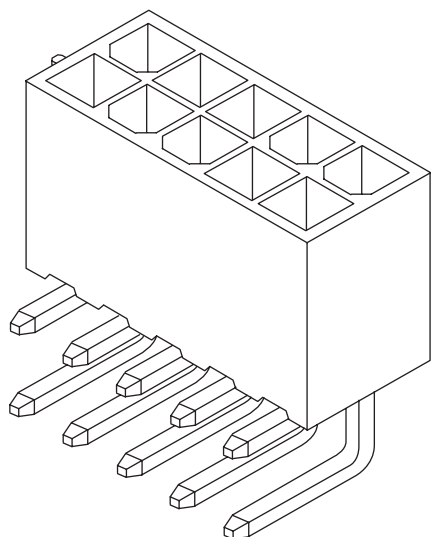

Material

I/NO	DESCRIPTION	TITLE	MATERIAL
1	WAFER	SMAW420	PA66, UL94 V Grade
2	PIN(An)		Brass & Tin-Plated

Available Pin

PARTS NO.	A	B	C
SMAW420-02P	5.4	3.3	-
SMAW420-04P	9.6	7.5	4.2
SMAW420-06P	13.8	11.7	8.4
SMAW420-08P	18.0	15.9	12.6
SMAW420-10P	22.2	20.1	16.8
SMAW420-12P	26.4	24.3	21.0
SMAW420-14P	30.6	28.5	25.2
SMAW420-16P	34.8	32.7	29.4
SMAW420-18P	39.0	36.9	33.6
SMAW420-20P	43.2	41.1	37.8
SMAW420-22P	47.7	45.6	42.0
SMAW420-24P	51.6	49.5	46.2

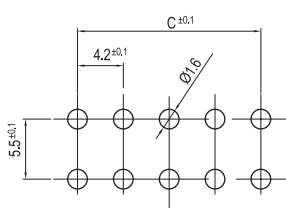
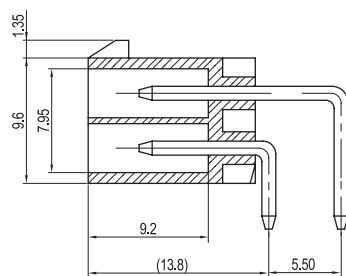
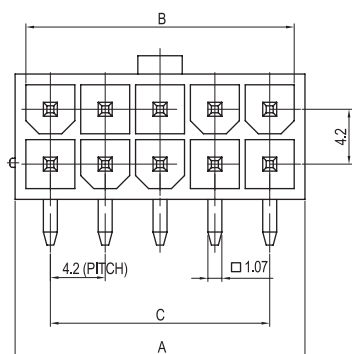
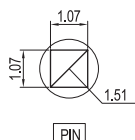
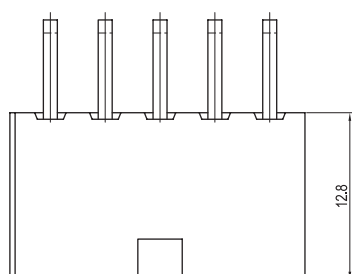

PCB LAYOUT

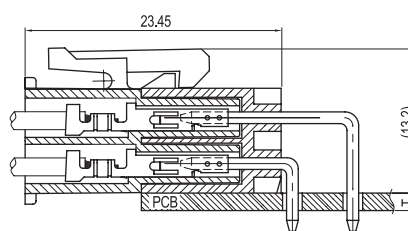

Specification

ITEM	SPEC
Voltage Rating	AC/DC 600V
Current Rating	AC/DC 9A
Operating Temperature	-25°C ~ +85°C
Contact Resistance	30mΩ MAX
Withstanding Voltage	AC1500V/1min
Insulation Resistance	1000MΩ MIN
Applicable Wire	-
Applicable P.C.B	1.2~1.6mm
Applicable FPC/FFC	-
Solder Height	-
Crimp Tensile Strength	-
UL FILE NO	-