

### Features:

- Wide DC input voltage (~55V)
- High power conversion efficiency (91% for SI-8243B)
- Precise setting voltage (1% for SI-8053B)
- Output power control by external components
- High-reliability passivated power chip and flip-chip control circuit

### Outline Drawings Unit: mm

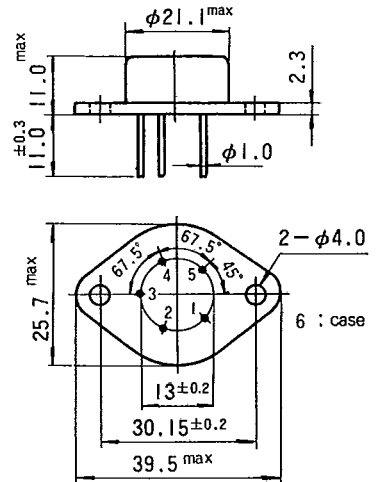

### Absolute Maximum Ratings (Ta=25°C)

Description	Type No.	SI-8053B	SI-8093B	SI-8123B	SI-8153B	SI-8243B
DC Input Voltage (V)		60				
Output current (A)		3.5				
Power Dissipation (W)		28 (Tc=25°C) 2.5 (Without heat sink)				
Thermal Resistance (°C/W)		3.5				
Junction Temperature (°C)		-30 ~ +125				
Operational Temperature (°C)		-20 ~ +80				
Storage Temperature (°C)		-30 ~ +125				

### Electrical Characteristics (Ta=25°C)

Description	Type No.	SI-8053B			SI-8093B			SI-8123B			SI-8153B			SI-8243B		
		MIN	TYP	MAX	MIN	TYP	MAX	MIN	TYP	MAX	MIN	TYP	MAX	MIN	TYP	MAX
DC Input Voltage (V)		15		55	18		55	20		55	20		55	30		55
	Conditions	3A			3A			3A			3A			3A		
Output Voltage (V)		4.95	5.05	5.15	8.85	9.05	9.25	11.85	12.05	12.25	14.85	15.05	15.25	23.85	24.04	24.25
	Conditions	30V, 2A			30V, 2A			30V, 2A			30V, 2A			40V, 2A		
Output Current (A)				3			3			3			3			3
	Conditions	30V, 2A			30V, 2A			30V, 2A			30V, 2A			40V, 2A		
Efficiency (%)			74			83			86			89			91	
	Conditions	30V, 2A			30V, 2A			30V, 2A			30V, 2A			40V, 2A		
Line Regulation (mV)			30			80			90			100			100	
	Input Volt.	25~35V			25~35V			25~35V			25~35V			35~45V		
	Output Curr.	2A			2A			2A			2A			2A		
Load Regulation (mV)			15			15			15			15			15	
	Input Volt.	30V			30V			30V			30V			40V		
	Output Curr.	0.5~3.0A			0.5~3.0A			0.5~3.0A			0.5~3.0A			0.5~3.0A		
Temperature Coefficient of Output Voltage (mV/°C)			±1			±2			±2			±2			±3	
	Conditions	30V, 2A			30V, 2A			30V, 2A			30V, 2A			40V, 2A		

### Equivalent Circuit

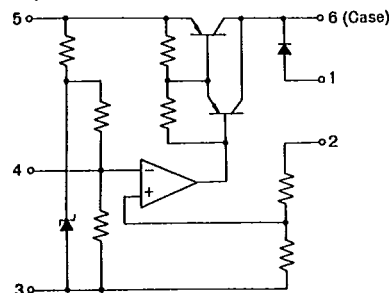

### External Wiring

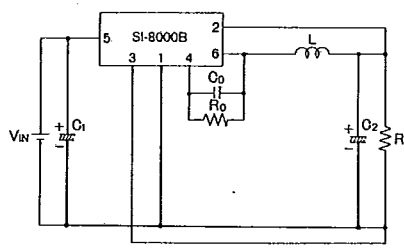

C0, R0 : External capacitor and resistor for self oscillation circuit

C1 : Protection capacitor against parasitic oscillation

C2, L : Capacitor and inductor for output filter

### Note for Wiring

The wiring between input capacitor C1 and input terminal 5 shall be as short as possible.  
 AC filter capacitor can be used as the substitute of input capacitor if the wiring between filter capacitor and input terminal is short like a few cm.  
 Thick solid line of "External Wiring" indicates that good conductor (e.g., short and thick cables or PCB conductors) shall be used.  
 The wiring between pin 4 and C<sub>0</sub>, R<sub>0</sub> shall be as short as possible.

### Selection of output filter capacitor C<sub>2</sub> and choke coil L

Ripple current I<sub>rip</sub> through the capacitor C<sub>2</sub> is given by:

$$I_{rip} = \frac{(V_{IN} - V_o) \cdot V_o}{L \cdot V_{IN} \cdot f}$$

where f = Oscillation frequency  
 Inductance L shall be selected to meet I<sub>rip</sub>/2 = I<sub>o min</sub>.

Design consideration shall be made on the heat dissipation from the filtering trioidal inductance due to the ripple current and on the ripple current rating of output capacitor.

### Over Current Protection Circuit (1)

The circuit diagram below is an external current limiter which has a current detecting resistor inserted between minus output and load.

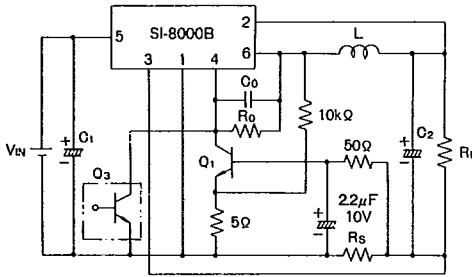

### Over Current Protection Circuit (2)

The circuit diagram below is an external current limiter which has a current detecting resistor inserted between plus output and load.

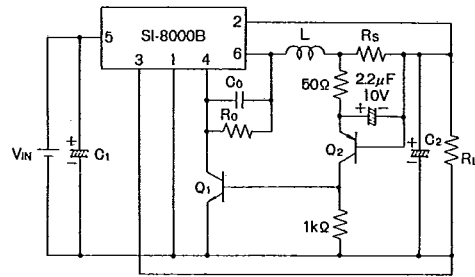

### Selection of Overcurrent Sensing Resistor R<sub>s</sub>

Short-circuit protection starting current I<sub>s1</sub> shall be determined so that R<sub>s</sub> · I<sub>s1</sub> = 0.5.

Appropriate power resistor R<sub>s</sub> shall be used to manage the power R<sub>s</sub> · I<sub>s1</sub><sup>2</sup>.

### Selection of resistor R<sub>0</sub> and capacitor C<sub>0</sub>

SI-8000B series are self-exciting switching regulators and the switching frequency f is changed by the fluctuation of V<sub>IN</sub> and I<sub>o</sub>. R<sub>0</sub> is to be selected around a few hundred kΩ so that the switching frequency f may be about 20kHz. The switching frequency f will be raised by increasing R<sub>0</sub> and reduced by decreasing R<sub>0</sub>.

Considering the switching frequency f is changed by the fluctuation of V<sub>IN</sub> and I<sub>o</sub>, select suitable R<sub>0</sub> which keeps the switching frequency f to be 20kHz at the lowest.

R<sub>0</sub> shall be also changed in accordance with L and C<sub>2</sub>.

Then attach C<sub>0</sub> of 100pF.

If the rising characteristics of switching waveform is not desirable, replace it by a capacitor of 200pF.

### OF-OFF control by external signal

The circuit diagram below is an external on-off control of output voltage.

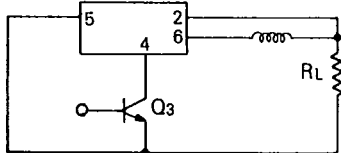

The circuit below is a thermal shut down circuit against overload.

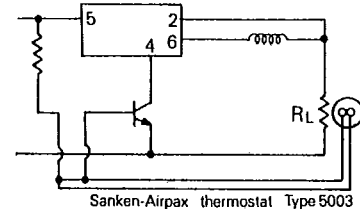

Sanken-Airpax thermostat Type 5003

### Derating

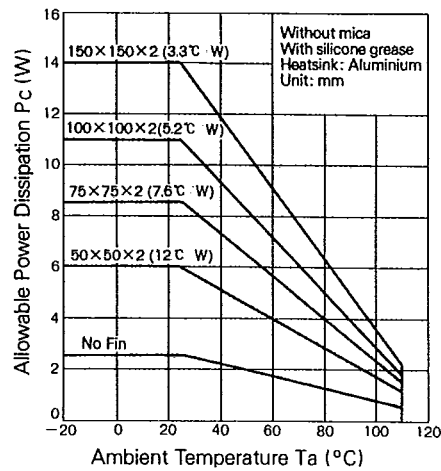

Calculation of power dissipation P<sub>c</sub>  
 Power dissipation P<sub>c</sub> is given by the following.

$$P_c = \left( \frac{100}{\eta'} - 1 \right) P_o$$

where: η' : Efficiency  $\left( \frac{P_o}{P_{IN}} \times 100 \right)$   
 P<sub>o</sub>: Output power (V<sub>o</sub> × I<sub>o</sub>)

$$\eta' = \eta + \alpha (V_{IN} - V'_{IN})$$

where: η' : Efficiency  
 V'IN: Average value of maximum operation input voltage

V<sub>IN</sub>, α:

	V <sub>IN</sub>	α
SI-8053B	30V	0.3
SI-8093B	30V	0.2
SI-8123B		
SI-8153B		
SI-8243B	40V	0.2

The efficiency η is measured at switching frequency f ≈ 20kHz. When f increases, the efficiency will be decreased.

### Specifications of rectifier diodes, transistors and choke coils

The following part numbers are for your reference.

Products	Part numbers	Makers
Rectifier diodes	RM4Z (Discrete diode)	Sanken
Rectifier diodes	CTM-21S (Centertap. Cathode common)	Sanken
Rectifier diodes	CTM-21R (Centertap. Anode common)	Sanken
Rectifier diodes	RB40Z (Bridge)	Sanken
Transistor Q <sub>1</sub> , Q <sub>3</sub>	2SC945	NEC
	MPS8098	MOTA
Transistor Q <sub>2</sub>	2SA733	NEC
	MPS8598	MOTA
Thermostat Th <sub>1</sub>	5003-F-105°C	Sanken
Choke coils	SN-10-500 (110μH, 3A)	TOHOKU
	SF-T10-50 (110μH, 3A)	TDK