



# SBFP540B

## UHF to C Band Low Noise Amplifier, Oscillation Applications

### Features

- Low noise :  $NF=0.9\text{dB typ (}f=1.8\text{GHz)}$ .
- High cut-off frequency :  $f_T=20\text{GHz typ (}V_{CE}=1\text{V)}$ .  
:  $f_T=29\text{GHz typ (}V_{CE}=4\text{V)}$ .
- Low voltage operation.
- High Gain :  $|S_{21e}|^2=18.5\text{dB typ (}f=1.8\text{GHz)}$ .
- Ultrasmall (1006 size), thin (0.5mm) leadless package.

### Package Dimensions

unit : mm

2214

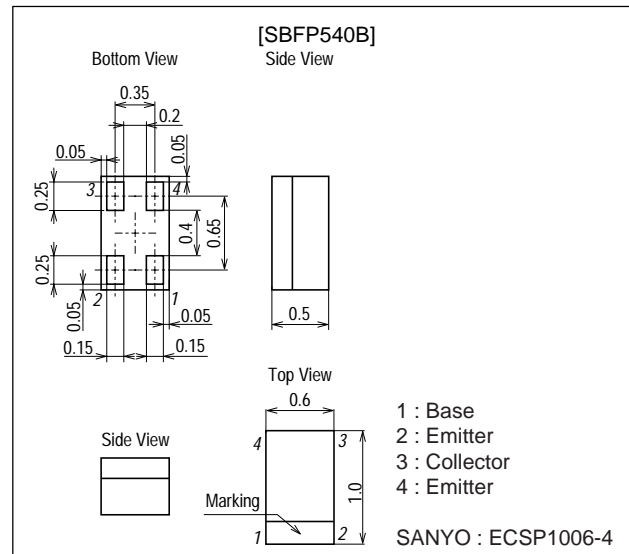

### Specifications

Absolute Maximum Ratings at  $T_a=25^\circ\text{C}$ 

Parameter	Symbol	Conditions	Ratings	Unit
Collector-to-Base Voltage	$V_{CB0}$		14	V
Collector-to-Emitter Voltage	$V_{CEO}$		4.5	V
Emitter-to-Base Voltage	$V_{EBO}$		1	V
Collector Current	$I_C$		80	mA
Collector Dissipation	$P_C$		100	mW
Junction Temperature	$T_j$		150	$^\circ\text{C}$
Storage Temperature	$T_{stg}$		-55 to +150	$^\circ\text{C}$

Electrical Characteristics at  $T_a=25^\circ\text{C}$ 

Parameter	Symbol	Conditions	Ratings			Unit
			min	typ	max	
Collector Cutoff Current	$I_{CB0}$	$V_{CB}=5\text{V, }I_E=0$			200	nA
Emitter Cutoff Current	$I_{EBO}$	$V_{EB}=1\text{V, }I_C=0$			70	$\mu\text{A}$
DC Current Gain	$h_{FE}$	$V_{CE}=3.5\text{V, }I_C=20\text{mA}$	50		200	
Gain-Bandwidth Product	$f_T1$	$V_{CE}=1\text{V, }I_C=10\text{mA}$		20		GHz
	$f_T2$	$V_{CE}=4\text{V, }I_C=50\text{mA}$	22	29		GHz
Reverse Transfer Capacitance	$C_{re}$	$V_{CB}=1\text{V, }f=1\text{MHz}$		0.15	0.25	pF

Marking : AF

Continued on next page.

- Any and all SANYO products described or contained herein do not have specifications that can handle applications that require extremely high levels of reliability, such as life-support systems, aircraft's control systems, or other applications whose failure can be reasonably expected to result in serious physical and/or material damage. Consult with your SANYO representative nearest you before using any SANYO products described or contained herein in such applications.
- SANYO assumes no responsibility for equipment failures that result from using products at values that exceed, even momentarily, rated values (such as maximum ratings, operating condition ranges, or other parameters) listed in products specifications of any and all SANYO products described or contained herein.

**SANYO Electric Co., Ltd. Semiconductor Company**

TOKYO OFFICE Tokyo Bldg., 1-10, 1 Chome, Ueno, Taito-ku, TOKYO, 110-8534 JAPAN

# SBFP540B

Continued from preceding page.

Parameter	Symbol	Conditions	Ratings			Unit
			min	typ	max	
Forward Transfer Gain	$ S_{21e} ^{21}$	$V_{CE}=1V, I_C=10mA, f=1.8GHz$		17.5		dB
	$ S_{21e} ^{22}$	$V_{CE}=2V, I_C=20mA, f=1.8GHz$	16	18.5		dB
Noise Figure	NF	$V_{CE}=2V, I_C=5mA, f=1.8GHz$		0.9	1.3	dB

## Electrical Connection (Top view)

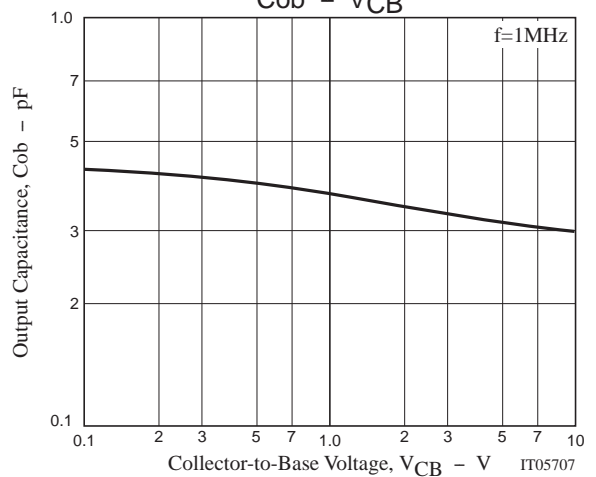
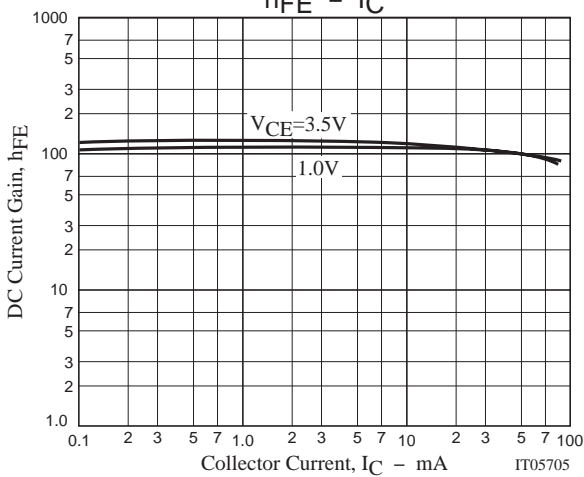
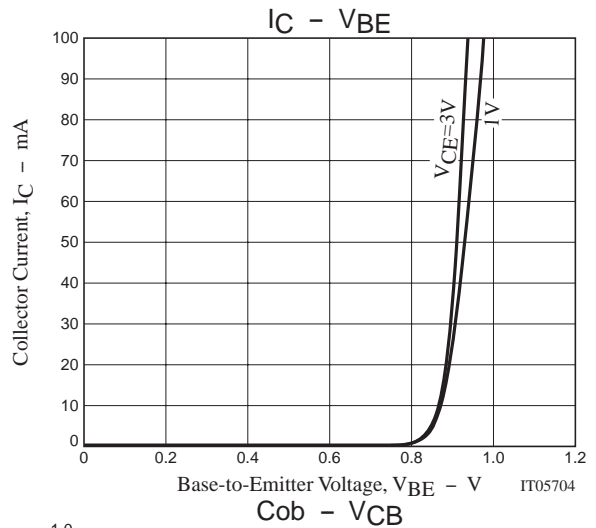
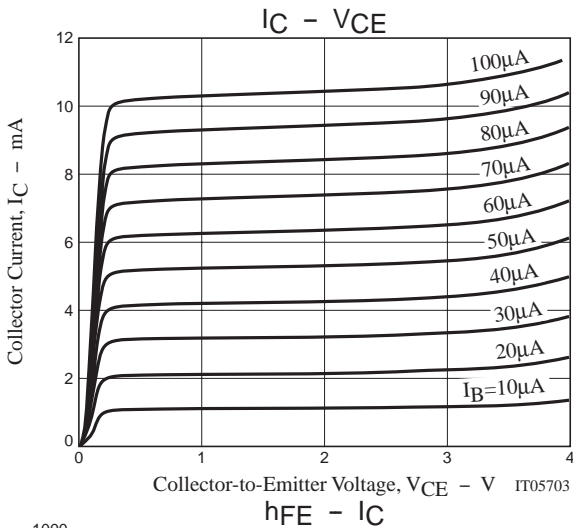
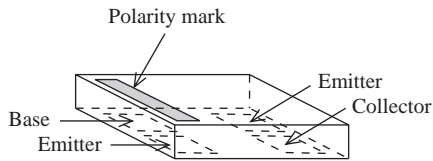
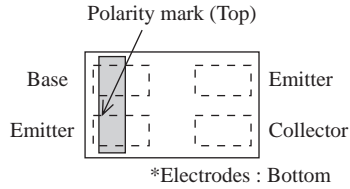

# SBFP540B

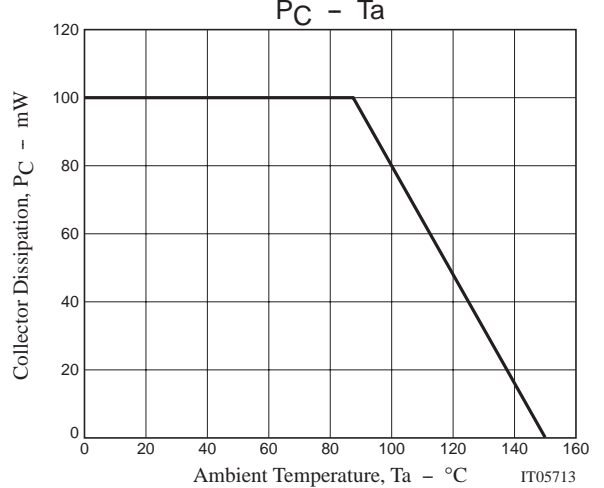
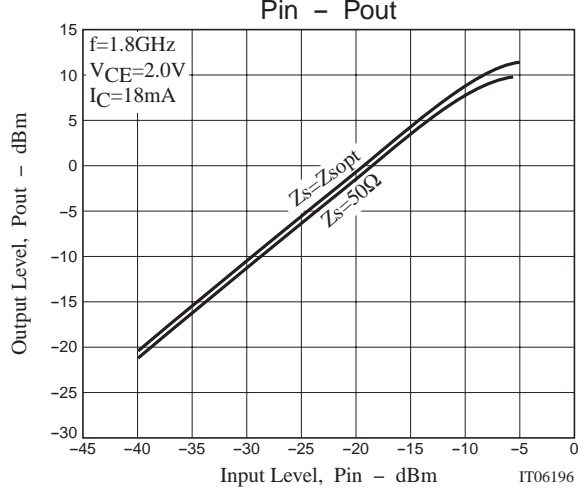
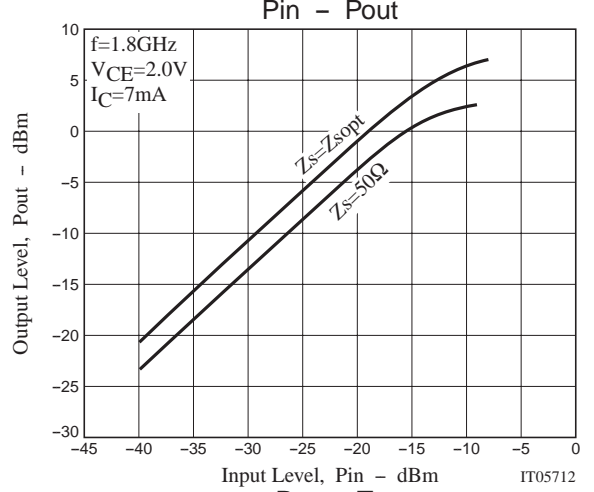
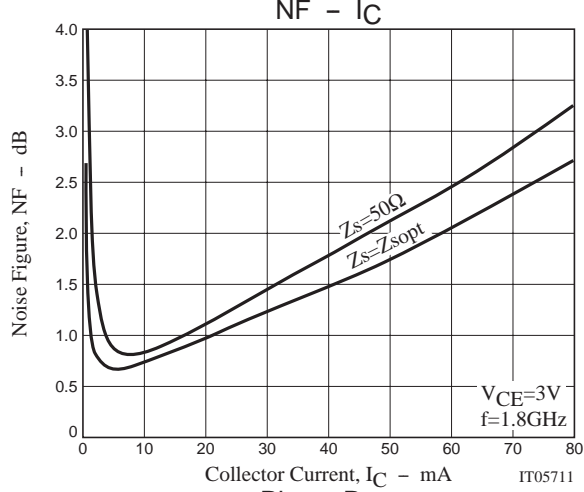
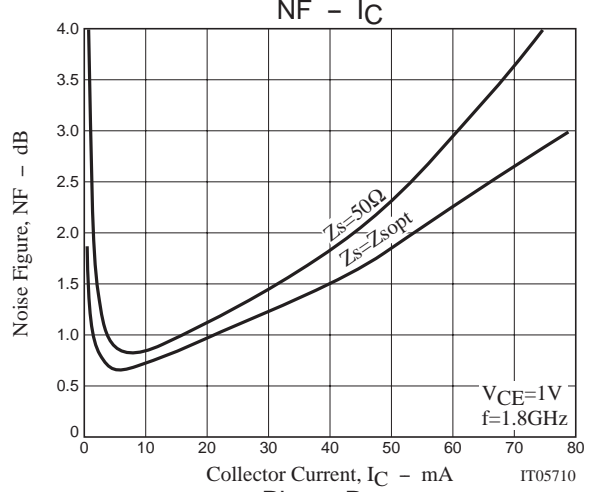
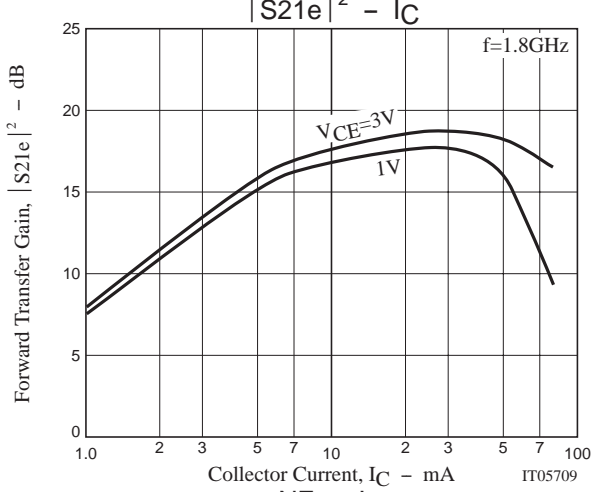
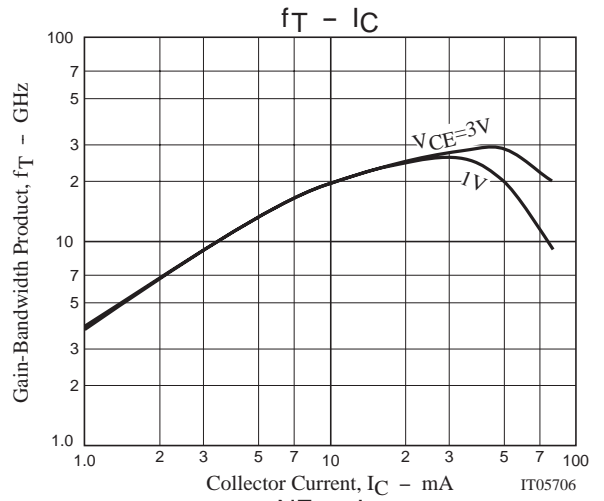
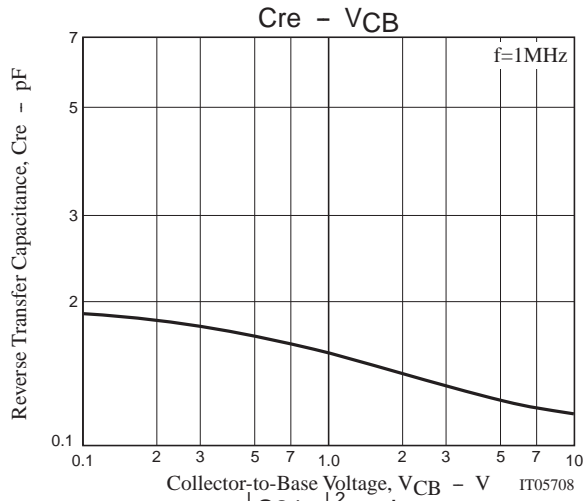

## SBFP540B

### SPICE PARAMETERS

model : Gummel-Poon

Parameter	Value	Unit	Parameter	Value	Unit
IS	82.84a	A	TF	6.76p	S
BF	107.5		XTF	0.4219	
NF	1		VTF	0.23794	V
VAF	28.383	V	ITF	1m	A
IKF	0.48731	A	PTF	0	deg
ISE	11.15p	A	CJC	234f	F
NE	3.19		VJC	0.81969	V
BR	5.5		MJC	0.30232	
NR	1		XCJC	0.3	
VAR	19.705	V	TR	2.324n	S
IKR	0.02	A	FC	0.73234	
ISC	19.237a	A	CJS	0	F
NC	1.172		VJS	0.75	V
RB	1.3	$\Omega$	MJS	0	
IRB	729.83 $\mu$	A	CC	100f	F
RBM	5.4	$\Omega$	Cbc	4f	F
RE	0.31111	$\Omega$	Cbe	100f	F
RC	4	$\Omega$	Lb	0.6n	H
XTB	0		Lc	0.6n	H
EG	1.11	eV	Le	0.3n	H
XTI	3				
CJE	1.8063f	F			
VJE	0.8051	V			
MJE	0.46576				

### SCHEMATIC

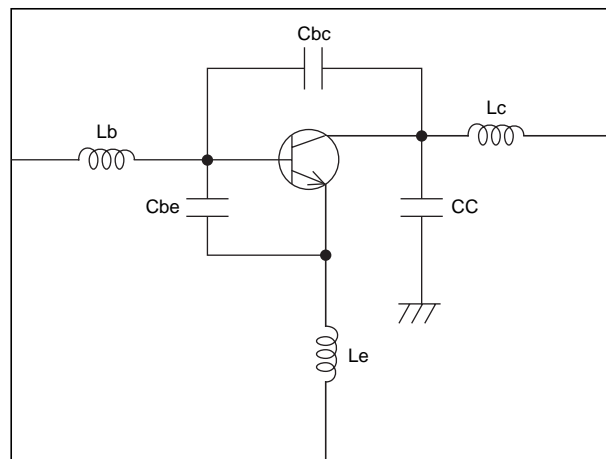

\*Information (including circuit diagrams and circuit parameters) herein is for example only ;  
it is not guaranteed for volume production.

## SBFP540B

### S Parameters (Common emitter)

V<sub>CE</sub>=1V, I<sub>C</sub>=1mA, Z<sub>O</sub>=50Ω

Freq(MHz)	S <sub>11</sub>	∠S <sub>11</sub>	S <sub>21</sub>	∠S <sub>21</sub>	S <sub>12</sub>	∠S <sub>12</sub>	S <sub>22</sub>	∠S <sub>22</sub>
200	0.964	-14.7	3.684	168.7	0.022	79.6	0.996	-7.1
400	0.940	-28.8	3.623	158.6	0.040	73.5	0.974	-13.8
600	0.942	-42.8	3.422	148.2	0.060	66.0	0.948	-20.3
800	0.920	-55.7	3.276	139.0	0.077	58.0	0.914	-26.4
1000	0.892	-67.7	3.080	128.9	0.092	50.9	0.878	-31.8
1200	0.875	-80.4	2.934	120.6	0.103	43.5	0.840	-36.9
1400	0.854	-90.3	2.750	113.1	0.114	37.0	0.807	-41.4
1600	0.827	-100.0	2.566	105.9	0.121	31.2	0.776	-45.7
1800	0.799	-109.2	2.392	99.2	0.126	25.6	0.745	-49.5
2000	0.797	-118.1	2.282	93.0	0.131	20.6	0.719	-53.0
2200	0.769	-126.7	2.125	86.7	0.134	16.1	0.697	-56.4
2400	0.756	-134.2	2.000	81.5	0.134	11.7	0.676	-59.7
2600	0.736	-141.4	1.876	75.6	0.135	8.2	0.657	-62.7
2800	0.731	-148.1	1.780	70.7	0.135	4.6	0.641	-65.7
3000	0.723	-154.5	1.697	65.5	0.133	1.4	0.628	-68.7
3200	0.719	-160.9	1.605	60.5	0.131	-1.2	0.615	-71.6
3400	0.708	-166.6	1.528	56.7	0.130	-3.5	0.603	-74.5
3600	0.705	-172.3	1.472	52.3	0.127	-6.3	0.592	-77.6
3800	0.697	-176.9	1.407	47.8	0.125	-7.8	0.584	-80.5
4000	0.699	177.5	1.349	44.3	0.121	-9.9	0.575	-83.5
4200	0.693	173.0	1.308	40.2	0.118	-11.0	0.568	-86.6
4400	0.697	167.8	1.252	36.3	0.116	-11.8	0.561	-89.7
4600	0.690	162.4	1.197	32.3	0.112	-12.6	0.556	-92.8
4800	0.686	158.3	1.155	28.7	0.110	-12.7	0.550	-96.0
5000	0.683	153.9	1.122	25.2	0.107	-12.4	0.544	-99.3
5200	0.679	149.7	1.086	21.4	0.104	-12.0	0.542	-102.4
5400	0.680	145.7	1.043	18.1	0.102	-11.7	0.537	-105.7
5600	0.685	141.5	1.015	14.7	0.101	-10.4	0.534	-109.0
5800	0.678	137.0	0.984	12.1	0.100	-8.9	0.530	-112.3
6000	0.688	132.4	0.955	8.2	0.100	-7.4	0.525	-115.6

## SBFP540B

### S Parameters (Common emitter)

$V_{CE}=1V, I_C=5mA, Z_O=50\Omega$

Freq(MHz)	$ S_{11} $	$\angle S_{11}$	$ S_{21} $	$\angle S_{21}$	$ S_{12} $	$\angle S_{12}$	$ S_{22} $	$\angle S_{22}$
200	0.857	-26.2	15.222	161.2	0.021	79.0	0.965	-14.4
400	0.811	-48.9	13.999	145.1	0.037	65.9	0.893	-27.2
600	0.749	-69.3	12.143	131.2	0.049	56.8	0.806	-37.8
800	0.704	-86.5	10.658	120.1	0.058	49.9	0.719	-46.5
1000	0.660	-101.1	9.232	109.4	0.065	44.4	0.641	-53.4
1200	0.620	-114.5	8.149	101.6	0.071	40.1	0.574	-59.0
1400	0.594	-124.6	7.213	95.0	0.074	36.3	0.523	-63.7
1600	0.575	-134.4	6.429	89.1	0.078	33.8	0.480	-67.5
1800	0.551	-142.7	5.767	83.9	0.081	32.1	0.443	-71.0
2000	0.546	-150.2	5.313	79.0	0.084	30.2	0.412	-74.1
2200	0.536	-157.7	4.829	74.2	0.086	29.2	0.388	-76.9
2400	0.520	-164.1	4.441	70.3	0.089	27.8	0.365	-79.7
2600	0.514	-170.4	4.104	66.1	0.092	26.8	0.346	-82.0
2800	0.510	-175.9	3.834	62.3	0.094	26.6	0.332	-84.4
3000	0.509	179.9	3.598	58.4	0.097	25.2	0.319	-87.0
3200	0.506	175.2	3.371	54.5	0.100	25.1	0.309	-89.4
3400	0.499	170.2	3.180	51.5	0.103	24.3	0.298	-91.9
3600	0.498	165.8	3.035	48.1	0.107	23.6	0.289	-94.3
3800	0.495	162.0	2.870	44.6	0.110	23.1	0.282	-96.9
4000	0.498	157.3	2.748	41.6	0.113	22.2	0.276	-99.4
4200	0.495	153.8	2.640	38.2	0.117	21.4	0.270	-102.1
4400	0.493	150.0	2.516	35.2	0.121	20.5	0.266	-105.1
4600	0.495	145.8	2.406	31.8	0.125	19.5	0.261	-107.8
4800	0.493	142.3	2.310	28.7	0.129	18.9	0.257	-110.7
5000	0.497	137.9	2.228	25.7	0.134	17.7	0.252	-113.5
5200	0.494	135.3	2.153	22.3	0.137	16.7	0.250	-116.5
5400	0.499	131.8	2.059	19.6	0.142	15.7	0.246	-119.7
5600	0.492	128.3	2.004	16.4	0.147	14.6	0.243	-122.8
5800	0.496	124.8	1.937	13.9	0.151	13.1	0.240	-126.0
6000	0.506	121.2	1.878	10.6	0.156	12.0	0.237	-129.0

## SBFP540B

### S Parameters (Common emitter)

$V_{CE}=1V, I_C=10mA, Z_O=50\Omega$

Freq(MHz)	$ S_{11} $	$\angle S_{11}$	$ S_{21} $	$\angle S_{21}$	$ S_{12} $	$\angle S_{12}$	$ S_{22} $	$\angle S_{22}$
200	0.724	-36.4	24.978	154.7	0.018	75.1	0.925	-20.6
400	0.673	-65.8	21.340	135.1	0.032	62.9	0.798	-37.3
600	0.606	-88.8	17.205	120.2	0.041	54.6	0.676	-49.4
800	0.559	-106.5	14.271	109.6	0.047	49.8	0.574	-58.3
1000	0.522	-120.9	11.886	99.9	0.052	46.2	0.496	-65.2
1200	0.506	-133.3	10.180	93.0	0.056	44.6	0.432	-70.6
1400	0.481	-142.4	8.864	87.4	0.061	43.0	0.387	-75.1
1600	0.468	-150.9	7.798	82.5	0.065	42.6	0.351	-79.1
1800	0.459	-159.3	6.941	78.1	0.069	42.0	0.319	-82.8
2000	0.463	-165.2	6.321	73.7	0.074	41.1	0.293	-85.7
2200	0.454	-171.5	5.727	69.6	0.078	40.2	0.274	-88.7
2400	0.451	-177.2	5.250	66.3	0.083	39.5	0.255	-91.8
2600	0.444	177.6	4.838	62.6	0.088	39.1	0.241	-94.4
2800	0.447	172.4	4.506	59.3	0.091	38.1	0.228	-97.0
3000	0.440	169.1	4.205	55.8	0.097	37.1	0.219	-99.5
3200	0.443	164.8	3.929	52.2	0.102	35.9	0.211	-102.1
3400	0.438	160.9	3.711	49.5	0.107	35.1	0.202	-104.9
3600	0.440	157.2	3.535	46.4	0.112	33.7	0.195	-107.6
3800	0.431	153.2	3.341	43.2	0.117	32.2	0.190	-110.3
4000	0.438	149.1	3.190	40.4	0.123	31.2	0.185	-112.9
4200	0.437	145.4	3.063	37.2	0.127	29.7	0.180	-116.2
4400	0.438	142.3	2.912	34.4	0.133	28.3	0.177	-119.3
4600	0.443	139.2	2.788	31.3	0.138	26.8	0.173	-122.1
4800	0.438	135.5	2.681	28.4	0.144	25.2	0.170	-125.2
5000	0.442	132.1	2.577	25.5	0.149	23.5	0.166	-128.2
5200	0.439	129.3	2.485	22.3	0.155	21.8	0.164	-131.5
5400	0.443	126.2	2.380	20.0	0.160	20.1	0.162	-135.2
5600	0.440	123.2	2.312	16.8	0.165	18.4	0.160	-138.6
5800	0.448	119.7	2.233	14.5	0.171	16.7	0.158	-142.1
6000	0.449	115.9	2.170	11.3	0.177	14.8	0.156	-145.5

## SBFP540B

### S Parameters (Common emitter)

VCE=1V, IC=20mA, ZO=50Ω

Freq(MHz)	S <sub>11</sub>	∠S <sub>11</sub>	S <sub>21</sub>	∠S <sub>21</sub>	S <sub>12</sub>	∠S <sub>12</sub>	S <sub>22</sub>	∠S <sub>22</sub>
200	0.587	-51.2	35.662	147.2	0.015	78.8	0.861	-28.1
400	0.520	-86.8	27.656	125.2	0.026	60.1	0.680	-47.3
600	0.474	-110.1	20.843	111.0	0.033	56.2	0.544	-59.5
800	0.454	-127.6	16.603	101.4	0.038	54.9	0.448	-68.2
1000	0.437	-140.1	13.485	92.9	0.043	53.2	0.380	-74.7
1200	0.428	-150.4	11.364	87.2	0.049	53.1	0.328	-80.4
1400	0.416	-158.3	9.812	82.3	0.055	52.2	0.291	-84.9
1600	0.416	-165.4	8.559	78.0	0.060	51.7	0.262	-89.3
1800	0.414	-171.8	7.596	74.2	0.065	50.5	0.239	-93.3
2000	0.415	-176.6	6.892	70.4	0.071	50.4	0.217	-97.1
2200	0.414	177.9	6.243	66.7	0.077	49.1	0.202	-100.5
2400	0.409	172.5	5.704	63.6	0.082	47.9	0.187	-104.2
2600	0.409	167.2	5.250	60.3	0.088	47.0	0.176	-107.5
2800	0.416	164.1	4.877	57.2	0.094	45.4	0.167	-110.6
3000	0.413	160.6	4.550	54.0	0.099	43.9	0.160	-113.6
3200	0.410	157.2	4.245	50.7	0.105	42.8	0.154	-116.8
3400	0.411	152.7	4.009	48.2	0.112	40.9	0.148	-120.0
3600	0.412	151.1	3.803	45.1	0.118	39.3	0.142	-123.2
3800	0.408	146.3	3.604	42.3	0.124	37.5	0.139	-126.8
4000	0.408	142.8	3.443	39.5	0.130	35.7	0.136	-129.8
4200	0.411	139.2	3.312	36.5	0.136	34.0	0.132	-133.1
4400	0.412	136.4	3.140	33.9	0.142	32.3	0.130	-136.7
4600	0.410	133.1	3.011	30.7	0.148	30.3	0.128	-140.0
4800	0.410	130.0	2.886	28.1	0.153	28.3	0.126	-143.7
5000	0.423	126.8	2.777	25.1	0.160	26.4	0.124	-147.2
5200	0.414	124.2	2.678	22.2	0.165	24.3	0.122	-150.7
5400	0.419	121.7	2.560	19.9	0.172	22.3	0.122	-154.9
5600	0.423	118.9	2.485	16.9	0.177	20.5	0.121	-158.6
5800	0.422	115.1	2.407	14.6	0.183	18.4	0.120	-163.0
6000	0.428	112.1	2.333	11.5	0.190	16.4	0.119	-166.5



## SBFP540B

### S Parameters (Common emitter)

$V_{CE}=1V, I_C=30mA, Z_O=50\Omega$

Freq(MHz)	$ S_{11} $	$\angle S_{11}$	$ S_{21} $	$\angle S_{21}$	$ S_{12} $	$\angle S_{12}$	$ S_{22} $	$\angle S_{22}$
200	0.480	-60.3	40.722	142.7	0.015	62.6	0.813	-32.3
400	0.463	-100.4	29.859	120.2	0.024	59.7	0.609	-52.3
600	0.428	-124.7	21.825	106.6	0.030	58.6	0.477	-64.0
800	0.419	-139.6	17.098	97.8	0.035	57.8	0.388	-72.3
1000	0.410	-151.7	13.775	90.0	0.041	57.6	0.328	-78.9
1200	0.415	-158.9	11.535	84.7	0.047	56.5	0.283	-84.5
1400	0.403	-166.8	9.938	80.1	0.053	56.3	0.251	-89.3
1600	0.402	-173.2	8.659	76.1	0.058	55.7	0.227	-93.9
1800	0.404	-178.9	7.684	72.5	0.064	54.3	0.206	-98.2
2000	0.410	177.5	6.962	68.8	0.070	54.1	0.188	-102.3
2200	0.405	172.0	6.297	65.3	0.077	52.4	0.175	-105.9
2400	0.406	167.8	5.758	62.4	0.083	51.0	0.163	-110.0
2600	0.416	162.9	5.295	59.1	0.089	49.9	0.153	-113.6
2800	0.414	159.1	4.916	56.3	0.095	48.3	0.145	-117.2
3000	0.408	156.1	4.585	53.1	0.101	46.5	0.140	-120.5
3200	0.414	153.4	4.280	49.9	0.107	45.1	0.135	-124.1
3400	0.413	150.0	4.040	47.3	0.113	43.1	0.130	-127.6
3600	0.415	146.2	3.838	44.5	0.119	41.6	0.126	-131.2
3800	0.409	143.8	3.633	41.5	0.127	39.3	0.124	-134.5
4000	0.410	139.3	3.465	38.8	0.133	37.4	0.121	-137.6
4200	0.409	136.5	3.328	35.9	0.139	35.6	0.118	-141.6
4400	0.414	134.3	3.160	33.3	0.145	33.5	0.117	-144.9
4600	0.412	130.5	3.031	30.3	0.151	31.6	0.115	-148.4
4800	0.416	127.8	2.901	27.5	0.157	29.5	0.114	-152.4
5000	0.420	125.0	2.797	24.9	0.164	27.5	0.112	-156.3
5200	0.409	122.3	2.696	21.9	0.169	25.5	0.112	-159.6
5400	0.422	119.4	2.574	19.5	0.176	23.3	0.112	-164.1
5600	0.422	115.9	2.500	16.3	0.181	21.2	0.112	-168.2
5800	0.425	112.3	2.422	14.3	0.188	19.0	0.111	-172.5
6000	0.428	110.4	2.350	11.3	0.194	16.9	0.112	-176.2

## SBFP540B

### S Parameters (Common emitter)

V<sub>CE</sub>=3V, I<sub>C</sub>=1mA, Z<sub>O</sub>=50Ω

Freq(MHz)	S <sub>11</sub>	∠S <sub>11</sub>	S <sub>21</sub>	∠S <sub>21</sub>	S <sub>12</sub>	∠S <sub>12</sub>	S <sub>22</sub>	∠S <sub>22</sub>
200	0.968	-13.9	3.707	169.3	0.019	82.7	0.996	-5.9
400	0.966	-27.3	3.643	159.8	0.032	73.7	0.983	-11.8
600	0.948	-40.0	3.468	150.1	0.046	68.3	0.964	-17.3
800	0.927	-53.1	3.344	141.5	0.061	61.3	0.940	-22.6
1000	0.909	-64.9	3.171	131.5	0.073	54.2	0.913	-27.6
1200	0.887	-76.9	3.037	123.6	0.083	47.6	0.883	-32.1
1400	0.859	-87.0	2.855	116.1	0.092	40.9	0.855	-36.3
1600	0.840	-96.8	2.688	108.8	0.099	35.0	0.827	-40.4
1800	0.811	-106.1	2.505	102.1	0.104	29.8	0.799	-43.9
2000	0.797	-114.9	2.400	96.0	0.107	24.4	0.774	-47.3
2200	0.779	-123.1	2.239	89.5	0.110	19.9	0.754	-50.5
2400	0.765	-130.6	2.104	84.5	0.111	15.5	0.732	-53.6
2600	0.738	-138.5	1.978	78.6	0.111	11.7	0.713	-56.6
2800	0.734	-145.3	1.880	73.6	0.111	8.4	0.696	-59.4
3000	0.731	-151.6	1.784	68.7	0.110	5.1	0.684	-62.3
3200	0.721	-157.6	1.706	63.7	0.109	2.7	0.672	-65.2
3400	0.705	-163.5	1.628	60.1	0.107	0.1	0.660	-67.9
3600	0.705	-169.4	1.556	55.9	0.105	-2.1	0.651	-70.8
3800	0.695	-174.8	1.488	51.1	0.103	-3.6	0.643	-73.5
4000	0.696	-179.4	1.428	47.5	0.099	-5.2	0.636	-76.3
4200	0.685	175.0	1.384	43.5	0.098	-6.1	0.628	-79.1
4400	0.683	170.0	1.325	39.5	0.095	-6.8	0.622	-82.0
4600	0.687	165.2	1.270	35.7	0.092	-7.2	0.616	-84.9
4800	0.683	160.0	1.222	31.9	0.089	-7.0	0.609	-87.8
5000	0.676	155.7	1.185	28.6	0.087	-6.6	0.604	-90.7
5200	0.669	151.7	1.151	24.5	0.085	-5.3	0.599	-93.7
5400	0.672	147.4	1.101	21.4	0.084	-4.1	0.594	-96.8
5600	0.673	142.9	1.075	17.9	0.083	-2.2	0.588	-99.8
5800	0.674	138.7	1.036	15.0	0.083	-0.2	0.583	-102.9
6000	0.677	134.1	1.008	11.4	0.084	2.1	0.578	-105.9

## SBFP540B

### S Parameters (Common emitter)

$V_{CE}=3V$ ,  $I_C=5mA$ ,  $Z_O=50\Omega$

Freq(MHz)	$ S_{11} $	$\angle S_{11}$	$ S_{21} $	$\angle S_{21}$	$ S_{12} $	$\angle S_{12}$	$ S_{22} $	$\angle S_{22}$
200	0.858	-24.2	15.230	162.5	0.016	74.0	0.975	-11.4
400	0.822	-44.3	14.234	147.6	0.028	70.1	0.919	-21.7
600	0.764	-62.5	12.543	134.2	0.039	60.0	0.851	-30.6
800	0.715	-80.0	11.164	123.3	0.047	53.6	0.779	-37.9
1000	0.656	-93.8	9.795	112.5	0.054	48.2	0.711	-43.8
1200	0.633	-107.3	8.720	104.5	0.058	44.2	0.650	-48.6
1400	0.597	-118.3	7.765	97.7	0.062	39.8	0.603	-52.5
1600	0.575	-127.7	6.942	91.6	0.065	37.6	0.561	-55.9
1800	0.543	-136.3	6.246	86.3	0.068	34.9	0.524	-58.8
2000	0.539	-144.1	5.760	81.2	0.071	33.8	0.494	-61.3
2200	0.522	-151.5	5.244	76.3	0.073	32.6	0.470	-63.6
2400	0.506	-157.8	4.829	72.4	0.075	31.2	0.447	-65.9
2600	0.496	-165.2	4.454	68.0	0.077	30.3	0.429	-68.0
2800	0.493	-171.1	4.166	64.2	0.080	30.0	0.413	-70.0
3000	0.491	-175.6	3.900	60.3	0.082	29.2	0.401	-72.3
3200	0.484	-180.0	3.663	56.5	0.085	28.9	0.390	-74.4
3400	0.468	175.1	3.454	53.4	0.088	27.8	0.380	-76.5
3600	0.475	170.3	3.290	50.1	0.091	27.6	0.372	-78.8
3800	0.470	166.4	3.124	46.7	0.093	26.8	0.365	-81.0
4000	0.474	161.0	2.980	43.6	0.097	26.4	0.359	-83.1
4200	0.471	157.3	2.865	40.2	0.100	25.9	0.353	-85.5
4400	0.469	152.9	2.727	37.1	0.104	25.1	0.348	-88.0
4600	0.467	149.7	2.608	33.8	0.107	24.5	0.344	-90.2
4800	0.469	146.2	2.507	30.7	0.111	23.5	0.339	-92.7
5000	0.465	141.9	2.423	27.5	0.115	22.7	0.334	-95.2
5200	0.465	138.8	2.332	24.4	0.118	21.6	0.330	-97.8
5400	0.469	134.8	2.231	21.6	0.123	20.6	0.325	-100.6
5600	0.470	131.3	2.163	18.4	0.127	19.8	0.321	-103.2
5800	0.472	127.9	2.093	16.1	0.131	18.5	0.317	-106.0
6000	0.477	124.2	2.029	12.6	0.136	17.4	0.313	-108.8

## SBFP540B

### S Parameters (Common emitter)

V<sub>CE</sub>=3V, I<sub>C</sub>=10mA, Z<sub>O</sub>=50Ω

Freq(MHz)	S <sub>11</sub>	∠S <sub>11</sub>	S <sub>21</sub>	∠S <sub>21</sub>	S <sub>12</sub>	∠S <sub>12</sub>	S <sub>22</sub>	∠S <sub>22</sub>
200	0.743	-31.0	25.035	156.8	0.014	70.5	0.946	-15.9
400	0.675	-57.9	21.960	138.4	0.025	65.2	0.844	-29.1
600	0.614	-79.6	18.119	123.8	0.033	57.0	0.742	-38.9
800	0.560	-97.3	15.295	113.0	0.038	53.6	0.651	-46.0
1000	0.517	-111.9	12.871	102.9	0.043	50.6	0.578	-51.4
1200	0.488	-124.7	11.110	95.8	0.047	47.7	0.516	-55.5
1400	0.469	-133.4	9.701	89.9	0.052	47.0	0.472	-58.8
1600	0.453	-143.8	8.550	84.7	0.055	45.9	0.435	-61.7
1800	0.431	-151.3	7.614	80.1	0.059	45.1	0.403	-64.2
2000	0.433	-157.7	6.951	75.7	0.063	44.4	0.377	-66.3
2200	0.424	-165.1	6.295	71.5	0.066	43.6	0.357	-68.3
2400	0.418	-170.6	5.771	68.1	0.070	42.4	0.337	-70.4
2600	0.410	-177.3	5.310	64.3	0.075	42.1	0.323	-72.2
2800	0.409	178.5	4.944	61.0	0.078	41.0	0.311	-74.0
3000	0.408	175.3	4.625	57.4	0.083	40.1	0.301	-76.1
3200	0.408	170.2	4.318	53.9	0.087	39.6	0.292	-78.1
3400	0.404	165.3	4.073	51.2	0.092	38.3	0.284	-80.0
3600	0.399	162.2	3.875	48.2	0.096	37.3	0.277	-82.2
3800	0.401	157.9	3.674	45.0	0.101	36.0	0.271	-84.3
4000	0.398	153.8	3.499	42.2	0.105	34.7	0.266	-86.3
4200	0.404	149.2	3.363	39.1	0.110	33.6	0.261	-88.5
4400	0.404	146.8	3.199	36.2	0.114	32.2	0.258	-90.9
4600	0.399	143.2	3.061	33.1	0.119	30.7	0.254	-93.2
4800	0.399	139.7	2.932	30.2	0.124	29.1	0.250	-95.6
5000	0.400	135.7	2.830	27.4	0.129	27.6	0.245	-98.0
5200	0.401	133.1	2.723	24.2	0.133	26.1	0.242	-100.6
5400	0.403	129.8	2.607	21.6	0.139	24.7	0.237	-103.4
5600	0.408	126.2	2.529	18.5	0.144	22.9	0.234	-106.1
5800	0.409	122.6	2.443	16.4	0.148	21.2	0.230	-108.8
6000	0.416	119.2	2.374	13.3	0.154	19.5	0.227	-111.7

## SBFP540B

### S Parameters (Common emitter)

V<sub>CE</sub>=3V, I<sub>C</sub>=20mA, Z<sub>O</sub>=50Ω

Freq(MHz)	S <sub>11</sub>	∠S <sub>11</sub>	S <sub>21</sub>	∠S <sub>21</sub>	S <sub>12</sub>	∠S <sub>12</sub>	S <sub>22</sub>	∠S <sub>22</sub>
200	0.587	-43.2	36.139	150.1	0.013	76.7	0.899	-21.2
400	0.532	-74.3	29.186	129.1	0.021	64.4	0.749	-36.1
600	0.475	-98.8	22.575	114.6	0.027	59.8	0.626	-45.4
800	0.428	-115.1	18.225	104.7	0.032	57.7	0.535	-51.7
1000	0.403	-130.2	14.913	95.7	0.037	56.1	0.466	-56.3
1200	0.393	-139.8	12.652	89.6	0.042	55.3	0.414	-59.9
1400	0.377	-149.0	10.917	84.5	0.046	54.7	0.376	-62.7
1600	0.372	-157.2	9.554	80.0	0.051	54.7	0.346	-65.2
1800	0.365	-163.8	8.483	76.1	0.056	53.7	0.319	-67.3
2000	0.370	-170.6	7.706	72.1	0.060	52.7	0.297	-69.3
2200	0.364	-175.8	6.954	68.4	0.065	51.8	0.281	-71.2
2400	0.361	178.7	6.360	65.3	0.070	50.7	0.265	-73.2
2600	0.362	172.7	5.864	61.9	0.075	49.7	0.252	-74.8
2800	0.359	169.6	5.438	58.8	0.080	48.7	0.243	-76.7
3000	0.362	166.1	5.075	55.6	0.086	47.1	0.235	-78.7
3200	0.359	162.3	4.734	52.4	0.091	46.1	0.228	-80.6
3400	0.355	157.5	4.465	49.9	0.097	43.9	0.222	-82.5
3600	0.362	155.1	4.245	46.9	0.101	42.6	0.215	-84.7
3800	0.359	151.2	4.025	44.0	0.107	40.9	0.211	-86.9
4000	0.356	147.8	3.832	41.2	0.112	39.3	0.207	-88.8
4200	0.362	143.9	3.682	38.2	0.117	37.2	0.202	-91.0
4400	0.361	141.2	3.496	35.7	0.123	35.9	0.200	-93.5
4600	0.356	137.6	3.342	32.6	0.128	33.8	0.197	-95.8
4800	0.362	134.2	3.205	29.8	0.133	32.0	0.193	-98.0
5000	0.371	130.4	3.093	27.0	0.139	30.3	0.189	-100.7
5200	0.364	128.4	2.977	24.2	0.144	28.6	0.186	-103.3
5400	0.369	126.3	2.846	21.8	0.149	26.6	0.183	-106.5
5600	0.373	122.0	2.762	18.7	0.155	24.7	0.180	-109.0
5800	0.372	118.2	2.669	16.6	0.160	22.6	0.176	-111.9
6000	0.379	115.3	2.586	13.6	0.165	20.6	0.173	-114.7

## SBFP540B

### S Parameters (Common emitter)

VCE=3V, IC=30mA, ZO=50Ω

Freq(MHz)	S <sub>11</sub>	∠S <sub>11</sub>	S <sub>21</sub>	∠S <sub>21</sub>	S <sub>12</sub>	∠S <sub>12</sub>	S <sub>22</sub>	∠S <sub>22</sub>
200	0.502	-49.8	41.895	146.5	0.010	63.4	0.867	-23.9
400	0.432	-85.8	32.242	124.6	0.019	63.5	0.698	-39.3
600	0.402	-109.3	24.185	110.5	0.025	63.1	0.572	-48.1
800	0.377	-125.9	19.201	101.2	0.029	62.6	0.482	-53.9
1000	0.361	-139.1	15.560	92.8	0.034	59.3	0.420	-57.9
1200	0.362	-149.3	13.117	87.2	0.040	60.2	0.371	-61.3
1400	0.355	-156.0	11.301	82.4	0.045	59.3	0.337	-63.7
1600	0.350	-164.2	9.853	78.2	0.050	58.1	0.311	-66.1
1800	0.344	-171.7	8.742	74.5	0.055	57.6	0.285	-68.2
2000	0.350	-175.6	7.930	70.8	0.060	56.7	0.266	-70.0
2200	0.348	179.8	7.161	67.2	0.066	54.7	0.252	-72.0
2400	0.345	174.0	6.548	64.3	0.071	53.6	0.237	-73.8
2600	0.343	168.1	6.022	60.9	0.076	52.4	0.227	-75.5
2800	0.350	164.1	5.591	58.0	0.081	50.8	0.218	-77.1
3000	0.343	161.9	5.219	54.9	0.087	49.8	0.211	-79.1
3200	0.344	158.7	4.866	51.7	0.093	47.8	0.204	-81.1
3400	0.343	153.8	4.584	49.3	0.098	46.4	0.199	-83.0
3600	0.347	151.6	4.358	46.5	0.103	44.8	0.193	-85.3
3800	0.342	148.4	4.130	43.6	0.109	42.5	0.190	-87.4
4000	0.347	143.2	3.938	40.9	0.115	40.7	0.186	-89.4
4200	0.348	140.2	3.776	38.0	0.120	38.8	0.182	-91.7
4400	0.351	138.5	3.588	35.4	0.125	37.2	0.179	-94.3
4600	0.352	134.8	3.434	32.5	0.131	35.2	0.176	-96.6
4800	0.350	131.6	3.290	29.7	0.137	33.2	0.173	-99.0
5000	0.362	129.1	3.172	27.0	0.142	31.2	0.169	-101.6
5200	0.352	126.9	3.059	24.1	0.148	29.2	0.166	-104.3
5400	0.359	123.5	2.923	21.7	0.154	27.3	0.163	-107.5
5600	0.362	120.4	2.837	18.7	0.158	25.3	0.161	-110.2
5800	0.359	116.0	2.744	16.6	0.164	23.2	0.157	-113.1
6000	0.360	113.6	2.654	13.5	0.170	21.5	0.155	-116.3

- Specifications of any and all SANYO products described or contained herein stipulate the performance, characteristics, and functions of the described products in the independent state, and are not guarantees of the performance, characteristics, and functions of the described products as mounted in the customer's products or equipment. To verify symptoms and states that cannot be evaluated in an independent device, the customer should always evaluate and test devices mounted in the customer's products or equipment.
- SANYO Electric Co., Ltd. strives to supply high-quality high-reliability products. However, any and all semiconductor products fail with some probability. It is possible that these probabilistic failures could give rise to accidents or events that could endanger human lives, that could give rise to smoke or fire, or that could cause damage to other property. When designing equipment, adopt safety measures so that these kinds of accidents or events cannot occur. Such measures include but are not limited to protective circuits and error prevention circuits for safe design, redundant design, and structural design.
- In the event that any or all SANYO products(including technical data, services) described or contained herein are controlled under any of applicable local export control laws and regulations, such products must not be exported without obtaining the export license from the authorities concerned in accordance with the above law.
- No part of this publication may be reproduced or transmitted in any form or by any means, electronic or mechanical, including photocopying and recording, or any information storage or retrieval system, or otherwise, without the prior written permission of SANYO Electric Co., Ltd.
- Any and all information described or contained herein are subject to change without notice due to product/technology improvement, etc. When designing equipment, refer to the "Delivery Specification" for the SANYO product that you intend to use.
- Information (including circuit diagrams and circuit parameters) herein is for example only ; it is not guaranteed for volume production. SANYO believes information herein is accurate and reliable, but no guarantees are made or implied regarding its use or any infringements of intellectual property rights or other rights of third parties.

This catalog provides information as of June, 2003. Specifications and information herein are subject to change without notice.

This datasheet has been download from:

[www.datasheetcatalog.com](http://www.datasheetcatalog.com)

Datasheets for electronics components.