

OMR7805SR	OMR7805ST	OMR7805NM	OMR7805NH
OMR7812SR	OMR7812ST	OMR7812NM	OMR7812NH
OMR7815SR	OMR7815ST	OMR7815NM	OMR7815NH

300 kRAD RADIATION TOLERANT 1.5 AMP POSITIVE FIXED VOLTAGE REGULATORS



**300K Rad Tolerant Three Terminal,
Positive Fixed Voltage Regulators
In Hermetic Packages**

FEATURES

- Isolated & Non-Isolated Hermetic Packages
- Output Voltages: +5V, +12V, +15V (Other Voltages Available)
- Output Voltages Set Internally To $\pm 1\%$ or $\pm 2\%$
- Built-In Thermal Overload Protection
- Short Circuit Current Limiting
- Radiation Tolerant up to 450 K Rad (Si)
- Available Hi-Rel Screened, Class B and Class S, MIL-STD-883

DESCRIPTION

These three terminal negative regulators are supplied in a high density hermetically sealed metal package and are available hi-rel screened. All protective features are designed into the circuit, including thermal shutdown, current limiting and safe-area control. With heat sinking, they can deliver over 1.5 amps of output current. These units feature internally trimmed output voltages to $\pm 1\%$ or 2% of nominal voltage. Standard voltages are +5V, +12V, and +15V. However, other voltages are available up to +24 volts. These devices are ideally suited for Space applications where small size, high reliability, and radiation tolerance is required. The high level of Radiation Tolerance of these devices makes them a desirable choice for LEO and many MEO and GEO communication satellites. Radiation testing is performed on a single wafer by wafer basis. Random die samples per wafer are selected, packaged and radiation tested to qualify each individual semiconductor wafer-by-wafer.

ABSOLUTE MAXIMUM RATINGS @ 25°C

Input Voltage	-35 V
Operating Junction Temperature Range	- 55°C to + 150°C
Storage Temperature Range	- 65°C to + 150°C
Power Dissipation: TO-205	1.1 W
TO-257/SMD-1/ D ² Pac	20 W
Lead Temperature (Soldering 10 seconds)	300°C
Surface Mount Package Soldering Temperature	250°C
Thermal Resistance, Junction to Case:	
TO-205	17°C/W
TO-257(Isolated), D ² Pac (Isolated)	4.2°C/W
SMD-1	3.5°C/W
Maximum Output Current: TO-205	0.5 A
TCASE-All Others	3.3A
Radiation Tolerant - Total Dose	300 K Rad (Si)

OMR7805SR
OMR7812SR
OMR7815SR

OMR7805ST
OMR7812ST
OMR7815ST

OMR7805NM
OMR7812NM
OMR7815NM

OMR7805NH
OMR7812NH
OMR7815NH

ELECTRICAL CHARACTERISTICS 5 Volt $V_{IN} = 10V, I_O = 500mA, -55^{\circ}C \leq T_A \leq 125^{\circ}C$ (unless otherwise specified)

Parameter	Symbol	Test Conditions	Min.	Max.	Unit
Output Voltage	V_{OUT}	$T_A = 25^{\circ}C$	4.92	5.08	V
		$V_{IN} = 7.5V$ to 20V	• 4.85	5.15	V
Line Regulation (Note 1)	V_{RLINE}	$V_{IN} = 7.5V$ to 20V	•	5	mV
		$V_{IN} = 8.0V$ to 12V	•	12	mV
Load Regulation (Note 1)	V_{RLOAD}	$I_O = 5mA$ to 1.5 Amp	•	4	mV
		$I_O = 250mA$ to 750 mA	•	10	mV
			•	12	mV
Standby Current Drain	I_{SCD}		•	25	mV
			•	6	mV
Standby Current Drain Change With Line	ΔI_{SCD} (Line)	$V_{IN} = 7.5V$ to 20V	•	15	mV
			•	6.5	mV
Standby Current Drain Change With Load	ΔI_{SCD} (Load)	$I_O = 5mA$ to 1000mA	•	0.8	mA
			•	0.5	mA
Dropout Voltage	V_{DO}	$T_A = 25^{\circ}C, \Delta V_{OUT} = 100mV, I_O = 1.0A$		2.5	V
Peak Output Current	$I_{O(pk)}$	$T_A = 25^{\circ}C$	1.5	3.3	A
Short Circuit Current (Note 2)	I_{DS}	$V_{IN} = 35V$	•	1.2	A
			•	2.8	A
Ripple Rejection	$\frac{\Delta V_{IN}}{\Delta V_{OUT}}$	$f = 120Hz, \Delta V_{IN} = 10V$	•	66	dB
		(Note 3)	•	60	dB
Output Noise Voltage (Note 3)	N_O	$T_A = 25^{\circ}C, f = 10Hz$ to 100KHz		40	$\mu V/V$ RMS
				75	mV
Long Term Stability (Note 3)	$\frac{\Delta V_{OUT}}{\Delta t}$	$T_A = 25^{\circ}C, t = 1000hrs.$			

ELECTRICAL CHARACTERISTICS 12 Volt $V_{IN} = 19V, I_O = 500mA, -55^{\circ}C \leq T_A \leq 125^{\circ}C$ (unless otherwise specified)

Parameter	Symbol	Test Conditions	Min.	Max.	Unit
Output Voltage	V_{OUT}	$T_A = 25^{\circ}C$	11.88	12.12	V
		$V_{IN} = 14.5V$ to 27V	• 11.64	12.36	V
Line Regulation (Note 1)	V_{RLINE}	$V_{IN} = 14.5V$ to 27V	•	18	mV
		$V_{IN} = 16V$ to 22V	•	50	mV
			•	9	mV
Load Regulation (Note 1)	V_{RLOAD}	$I_O = 5mA$ to 1.5 Amp	•	30	mV
		$I_O = 250mA$ to 750 mA	•	60	mV
			•	20	mV
Standby Current Drain	I_{SCD}		•	40	mV
			•	6.0	mA
Standby Current Drain Change With Line	ΔI_{SCD} (Line)	$V_{IN} = 15V$ to 30V	•	6.5	mA
			•	0.8	mA
Standby Current Drain Change With Load	ΔI_{SCD} (Load)	$I_O = 5mA$ to 1000mA	•	0.5	mA
			•	0.5	mA
Dropout Voltage	V_{DO}	$\Delta V_{OUT} = 100mV, I_O = 1.0A$	•	2.5	V
Peak Output Current	$I_{O(pk)}$	$T_A = 25^{\circ}C$	1.5	3.3	A
Short Circuit Current (Note 2)	I_{DS}	$V_{IN} = 35V$	•	1.2	A
			•	2.8	A
Ripple Rejection	$\frac{\Delta V_{IN}}{\Delta V_{OUT}}$	$f = 120Hz, \Delta V_{IN} = 10V$	•	61	dB
		(Note 3)	•	54	dB
Output Noise Voltage (Note 3)	N_O	$T_A = 25^{\circ}C, f = 10Hz$ to 100KHz		40	$\mu V/V$ RMS
				120	mV
Long Term Stability (Note 3)	$\frac{\Delta V_{OUT}}{\Delta t}$	$T_A = 25^{\circ}C, t = 1000hrs.$			

Notes:

1. Load and Line Regulation are specified at a constant junction temperature. Pulse testing with low duty cycle is used. Changes in output voltage due to heating effects must be taken into account separately.
2. Short Circuit protection is only assured up to $V_{IN} = 35V$.
3. If not tested, shall be guaranteed to the specified limits.
4. The • denotes the specifications which apply over the full operating temperature range.
5. Refer to curves for typical characteristics versus Total Dose Radiation Levels.



OMR7805SR
OMR7812SR
OMR7815SR

OMR7805ST
OMR7812ST
OMR7815ST

OMR7805NM
OMR7812NM
OMR7815NM

OMR7805NH
OMR7812NH
OMR7815NH

ELECTRICAL CHARACTERISTICS 15 Volt $V_{IN} = 23V, I_O = 500mA, -55^{\circ}C \leq T_A \leq 125^{\circ}C$ (unless otherwise specified)

Parameter	Symbol	Test Conditions	Min.	Max.	Unit
Output Voltage	V_{OUT}	$T_A = 25^{\circ}C$	14.8	15.2	V
		$V_{IN} = 18.5V$ to 30V	• 14.6	15.4	V
Line Regulation (Note 1)	V_{RLINE}	$V_{IN} = 17.5V$ to 30V	•	20	mV
		$V_{IN} = 20V$ to 26V	•	50	mV
Load Regulation (Note 1)	V_{RLOAD}	$I_O = 5mA$ to 1.5 Amp	•	15	mV
		$I_O = 5mA$ to 1.0 Amp	•	25	mV
		$I_O = 250mA$ to 750 mA	•	35	mV
Standby Current Drain	I_{SCD}		•	45	mV
			•	6.0	mA
Standby Current Drain Change With Line	ΔI_{SCD} (Line)	$V_{IN} = 18.5V$ to 30V	•	6.5	mA
			•	0.8	mA
Standby Current Drain Change With Load	ΔI_{SCD} (Load)	$I_O = 5mA$ to 1000mA	•	0.5	mA
			•	0.5	mA
Dropout Voltage	V_{DO}	$T_A = 25^{\circ}C, \Delta V_{OUT} = 100mV, I_O = 1.0A$		2.5	V
Peak Output Current	$I_{O(pk)}$	$T_A = 25^{\circ}C$	1.5	3.3	A
Short Circuit Current (Note 2)	I_{DS}	$V_{IN} = 35V$	•	1.2	A
			•	2.8	A
Ripple Rejection	ΔV_{IN} ΔV_{OUT}	$f = 120$ Hz, $\Delta V_{IN} = 10V$		54	dB
		(Note 3)	•	52	dB
Output Noise Voltage (Note 3)	N_O	$T_A = 25^{\circ}C, f = 10$ Hz to 100KHz		40	$\mu V/V$ RMS
Long Term Stability (Note 3)	ΔV_{OUT} Δt	$T_A = 25^{\circ}C, t = 1000$ hrs.		150	mV

Notes:

1. Load and Line Regulation are specified at a constant junction temperature. Pulse testing with low duty cycle is used. Changes in output voltage due to heating effects must be taken into account separately.
2. Short Circuit protection is only assured up to $V_{IN} = 35V$.
3. If not tested, shall be guaranteed to the specified limits.
4. The • denotes the specifications which apply over the full operating temperature range.
5. Refer to curves for typical characteristics versus Total Dose Radiation Levels.

RADIATION TEST PROGRAM

The following chart is a summary of the test data collected on Radiation Tolerant OMR7805/12/15 at various doses. The chart depicts the Total Radiation Dose that each device was exposed to on a step stress irradiation basis prior to failure. Failure is defined as any electrical test that does not meet the limits of the device per the published data sheet specifications after radiation testing.

Omnirel P/N	5K	10K	20K	30K	50K	60K	70K	80K	100K	150K	200	250	300	350	400	450	KRAD
OMR7805/12/15 Test Points																	
				X	X				X	X			X			X	



OMR7805SR
OMR7812SR
OMR7815SR

OMR7805ST
OMR7812ST
OMR7815ST

OMR7805NM
OMR7812NM
OMR7815NM

OMR7805NH
OMR7812NH
OMR7815NH

OMNIREL'S RADIATION TEST PROCEDURE

- Radiation Testing is performed on a single wafer by wafer basis.
- Each wafer is identified and a random sample of 5 die per wafer is selected.
- The die are then individually assembled in a hermetic package, data logged, electrically tested, hi-rel screened and then submitted to radiation testing.
- The packaged die are submitted to Steady State Total Dose radiation per Method 1019, Condition A, at a dose rate of 50 RAD/sec biased at maximum supply voltage.
- Final electrical test is performed within two hours of both Total Dose Radiation level from a Cobalt 60 source and 168 hr, 100°C annealing process. Read and record data including two non-radiated control samples.
- The wafer is then qualified only if samples from wafers meet full electrical specifications after 150% of total dose rating as specified in each product data sheet.
- Omnirel's controlling specifications are as follows: For Voltage Regulators the controlling specification is MIL-PRF- 38534/MIL-STD-883. For Rectifiers/Schottky the controlling specification is MIL-PRF-19500/MIL-STD-750.

AVAILABLE PRODUCT SCREENING

Standard Class Level Screening Per MIL-PRF-38535				
Screen	*Level B		*Level S	
	Test Method	Required	Test Method	Required
Wafer Lot Acceptance	-----	-----	5007	100%
Non-destructive Bond Pull	-----	-----	-----	-----
Pre-Cap Visual Inspection	2010	100%	2010	100%
Temperature Cycle	1010	100%	1010	100%
Constant Acceleration	2001	100%	2001	100%
Visual Inspection	-----	100%	-----	100%
PIND Test	-----	-----	2020	100%
Serialization	-----	-----	-----	100%
Pre-Burn-In Electrical	Data Sheet	100%	Data Sheet	100%
Burn-In	1015/160 hrs.	100%	1015/240hrs.	100%
Interim Electrical	-----	-----	Data Sheet	100%
PDA Calculations	5% Functional	Lot	5% Functional	Lot
Final Electrical	Data Sheet	100%	Data Sheet	100%
Fine & Gross Seal	1014	100%	1014	100%
Radiographic	-----	-----	2012/Two Views	100%
Conformance Inspection**	GR A	100%	GR A	100%
Final Visual Inspection	2009	Sample	2009	Sample

*Note: For "B" Level Screening add "M" to part number, for "S" Level Screening add "S" to part number. See Part Number Designator.
** Note: Additional conformance inspection testing, i.e. Group B,C & D optional.

OMR7805SR OMR7805ST OMR7805NM OMR7805NH
OMR7812SR OMR7812ST OMR7812NM OMR7812NH
OMR7815SR OMR7815ST OMR7815NM OMR7815NH
TYPICAL RADIATION CURVES

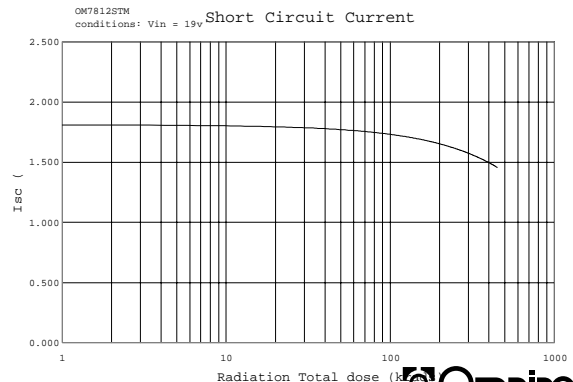
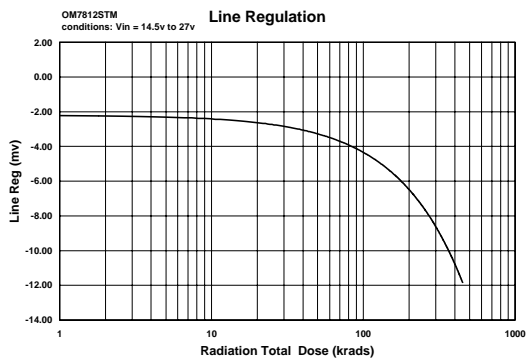
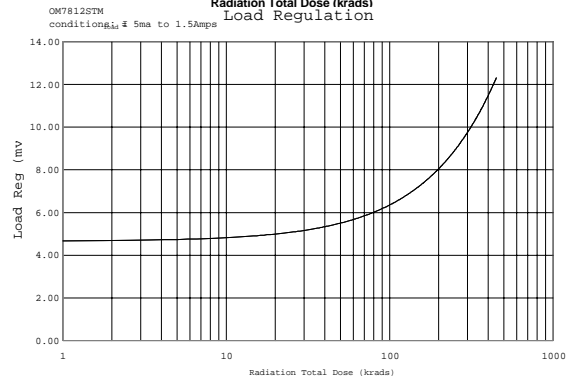
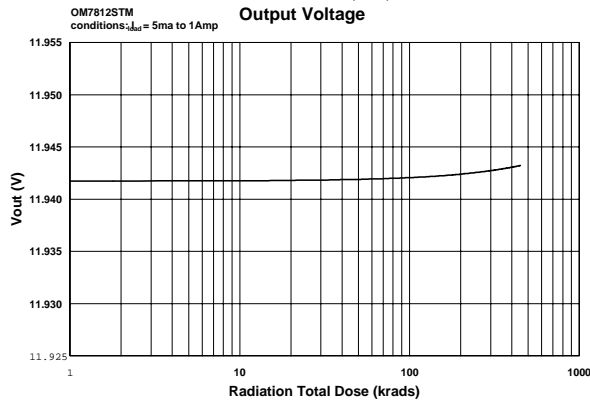
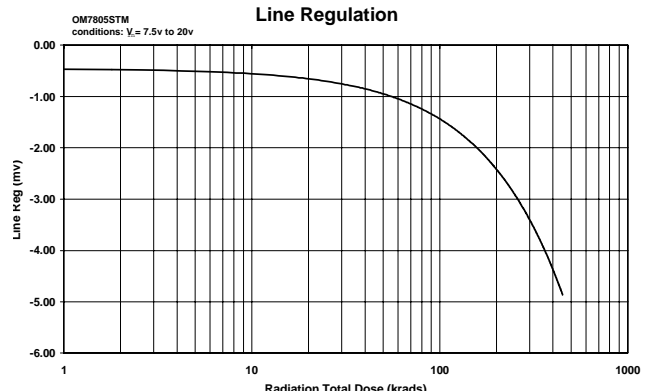
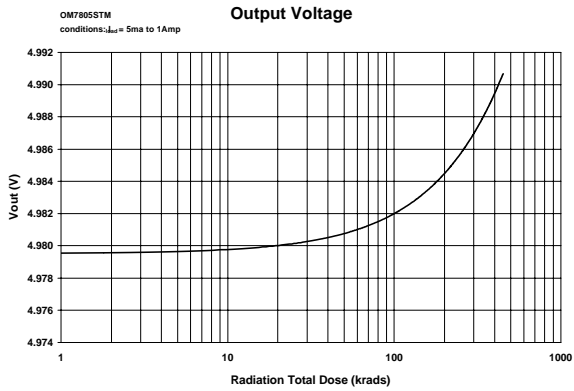
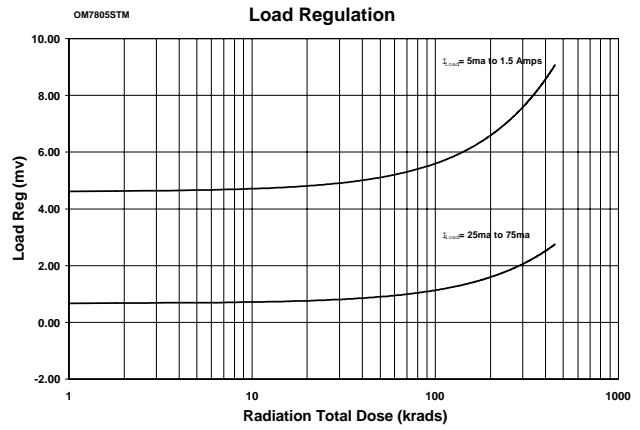
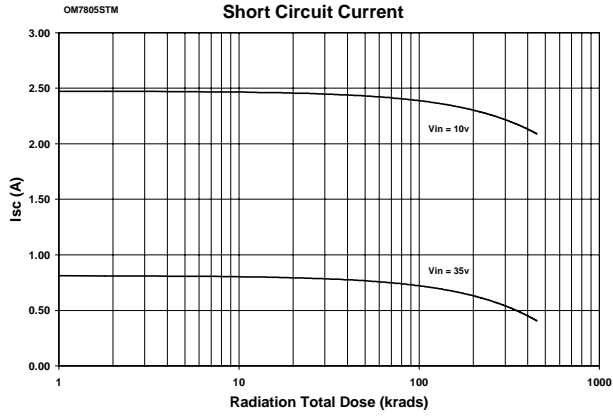

OMR7805SR
OMR7812SR
OMR7815SR

OMR7805ST
OMR7812ST
OMR7815ST

OMR7805NM
OMR7812NM
OMR7815NM

OMR7805NH
OMR7812NH
OMR7815NH

TYPICAL RADIATION CURVES

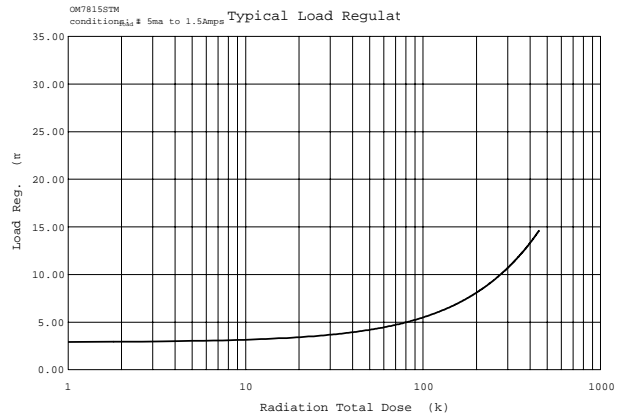
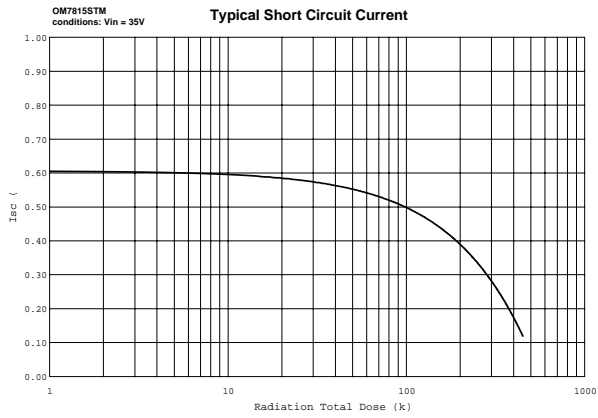
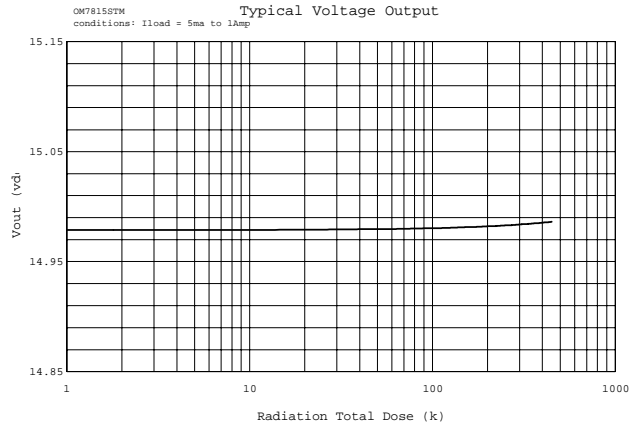
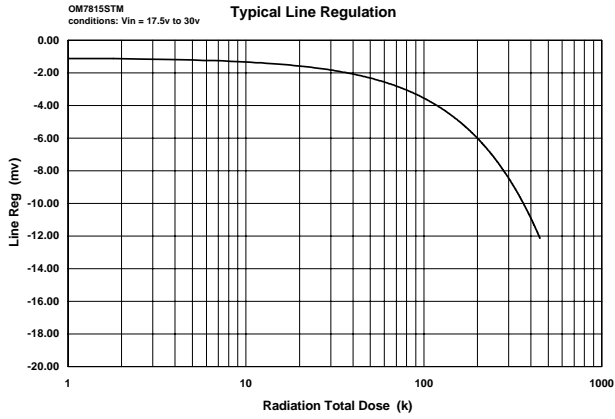

OMR7805SR
OMR7812SR
OMR7815SR

OMR7805ST
OMR7812ST
OMR7815ST

OMR7805NM
OMR7812NM
OMR7815NM

OMR7805NH
OMR7812NH
OMR7815NH

TYPICAL PERFORMANCE CHARACTERISTICS

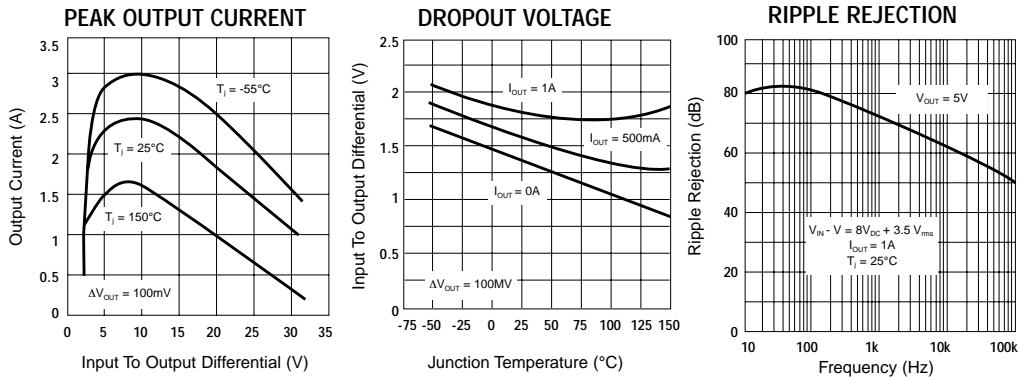

TYPICAL APPLICATIONS

Fixed Output Regulator

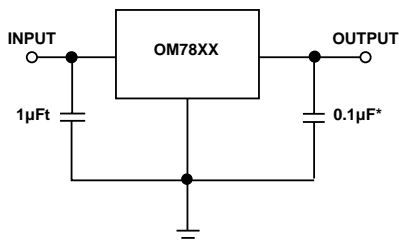

*Increasing value of output capacitor improves system transient response.
†Required only if regulator is located an appreciable distance from power supply filter.

Circuit For Increasing Output Voltage

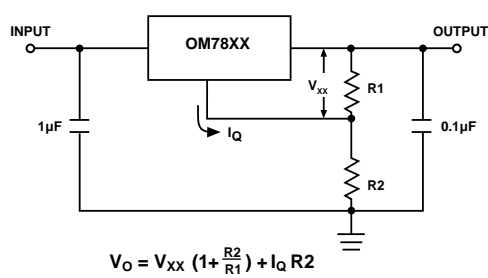

High Output Current, Short Circuit Protected

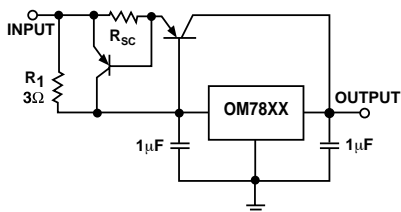

Adjustable Output Regulator, 7 To 30 Volts

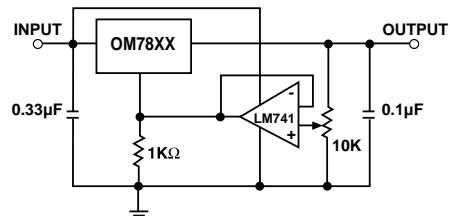

OMR7805SR OMR7805ST OMR7805NM OMR7805NH
 OMR7812SR OMR7812ST OMR7812NM OMR7812NH
 OMR7815SR OMR7815ST OMR7815NM OMR7815NH

MECHANICAL OUTLINES

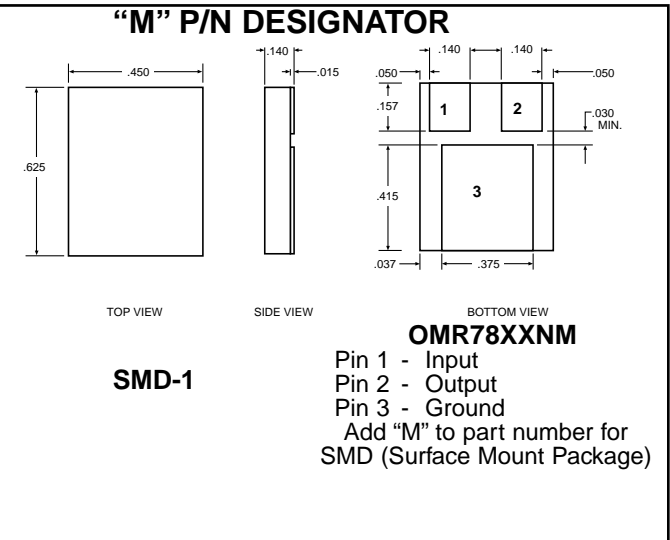
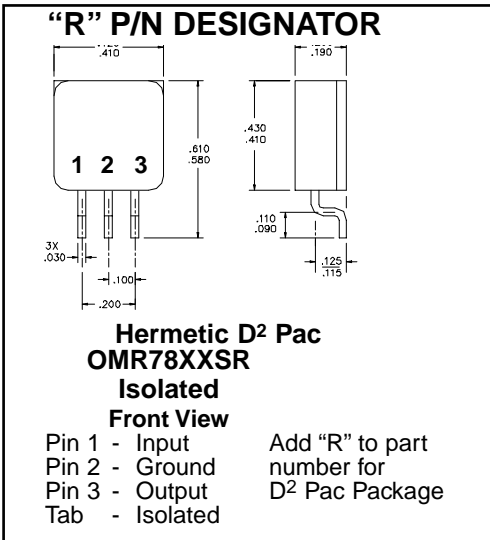
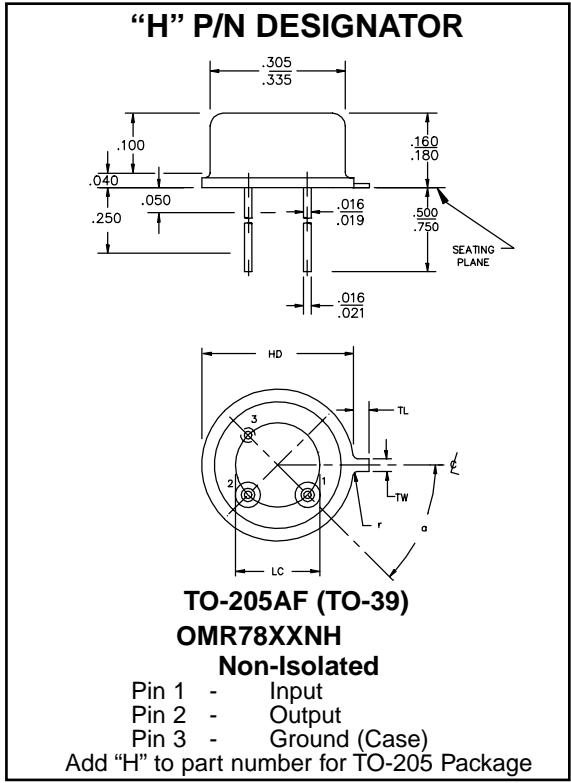
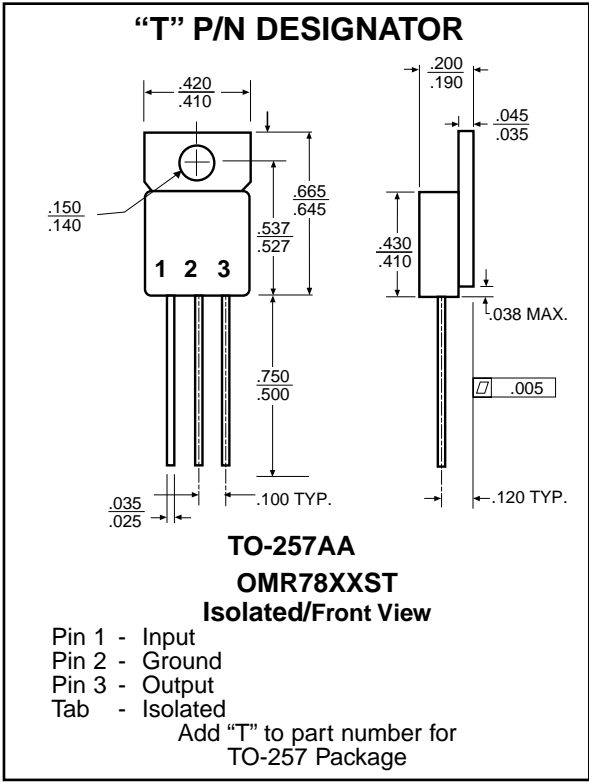

PART NUMBER DESIGNATOR
 (Example OMR7805STM)

