

Features

- Low Noise Figure
- Low Distortion
- Surface Mount Package
- Multifunction Integration
- Single Positive Supply
- 75 ohm Impedance

Description

M/A-COM's MAMUSS0007 is an integrated module consisting of an amplifier and two equal split power dividers. The push-pull, low distortion, amplifier includes the baluns and DC bias circuitry. The device is ideally suited for use in the CATV market where low noise figure, low distortion and high linearity are required.

Ordering Information

Part Number	Package
MAMUSS0007	SMT Package
MAMUSS0007SMB	Sample Test Board (Includes 5 Samples)

Absolute Maximum Ratings ¹

Parameter	Absolute Maximum
Input Power	+20 dBm
Operating Voltage	+10 volts
Operating Temperature	-40 °C to +85 °C
Storage Temperature	-65 °C to +150 °C

1. Exceeding any one or combination of these limits may cause permanent damage.

Functional Schematic

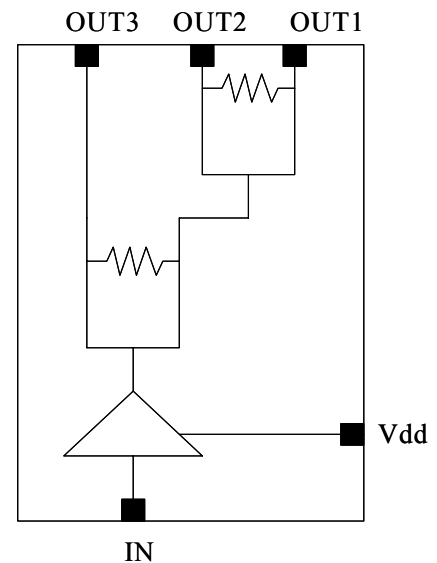

PIN No.	PIN Name	Description
1	GND	Ground
2	GND	Ground
3	GND	Ground
4	GND	Ground
5	GND	Ground
6	GND	Ground
7	GND	Ground
8	GND	Ground
9	IN	RF Input
10	GND	Ground
11	V _{DD}	+5V
12	GND	Ground
13	OUT 1	RF Output 1
14	GND	Ground
15	OUT 2	RF Output 2
16	GND	Ground
17	OUT 3	RF Output 3
18	GND	Ground

M/A-COM Inc. and its affiliates reserve the right to make changes to the product(s) or information contained herein without notice.

Visit www.macom.com for additional data sheets and product information.

■ **North America:** Tel. (800) 366-2266
 ■ **Asia/Pacific:** Tel. +81-44-844-8296, Fax +81-44-844-8298
 ■ **Europe:** Tel. +44 (1908) 574 200, Fax +44 (1908) 574 300

Electrical Specifications: $T_A = 25^\circ\text{C}$, Freq: 50 - 860 MHz, $V_{DD} = +5$ Volts, $Z_0 = 75$ ohms

Parameter	Test Conditions	Units	Min.	Typ.	Max.
Gain	IN-OUT1, IN-OUT2	dB		5	
Gain	IN-OUT3	dB		8.5	
Gain Unbalance	IN-OUT1 vs IN-OUT2	dB		0.6	
Gain Flatness	IN-OUT1/2	dB		1.6	
Gain Flatness	IN-OUT 3	dB		1.0	
Noise Figure	IN-OUT1, IN-OUT2 50 – 150 MHz 150 – 860 MHz	dB		3.7	
		dB		3.4	
Noise Figure	IN-OUT 3 50 – 150 MHz 150 – 860 MHz	dB		3.4	
		dB		3.0	
Return Loss	IN	dB		15	
Return Loss	OUT	dB		17	
Isolation	OUT-OUT	dB		24	
Composite Triple Beat, CTB	135 channels, +13 dBmV/ channel at the input.	dBc		-70	
Composite Second Order, CSO	135 channels, +13 dBmV/ channel at the input	dBc		-73	
Cross modulation	135 channels, +13 dBmV/ channel at the input.	dBc		-66	
I_{DD}	$V_{DD} = +5$ Volts	mA		200	

Static Sensitivity

Gallium Arsenide Integrated Circuits are sensitive to electrostatic discharge (ESD) and can be damaged by static electricity. Proper ESD control techniques should be used when handling these devices.

M/A-COM Inc. and its affiliates reserve the right to make changes to the product(s) or information contained herein without notice.

Visit www.macom.com for additional data sheets and product information.

2

- North America: Tel. (800) 366-2266
- Asia/Pacific: Tel. +81-44-844-8296, Fax +81-44-844-8298
- Europe: Tel. +44 (1908) 574 200, Fax +44 (1908) 574 300

Outline ²

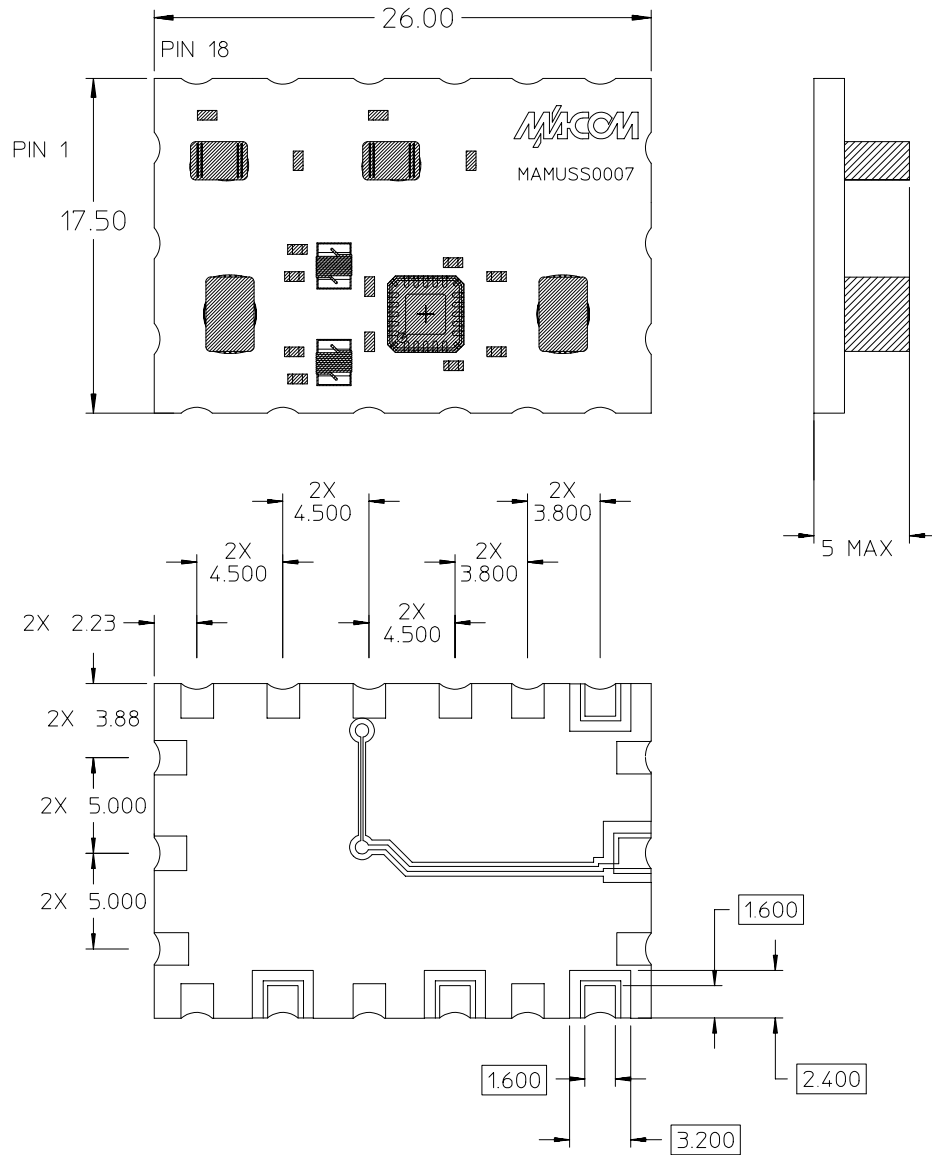

2. All dimensions in mm.

M/A-COM Inc. and its affiliates reserve the right to make changes to the product(s) or information contained herein without notice.

Visit www.macom.com for additional data sheets and product information.

- North America: Tel. (800) 366-2266
- Asia/Pacific: Tel. +81-44-844-8296, Fax +81-44-844-8298
- Europe: Tel. +44 (1908) 574 200, Fax +44 (1908) 574 300

Typical Performance Curves

In – Out 1

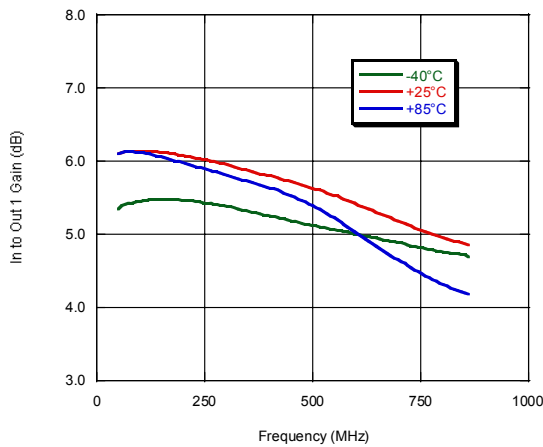

Noise Figure

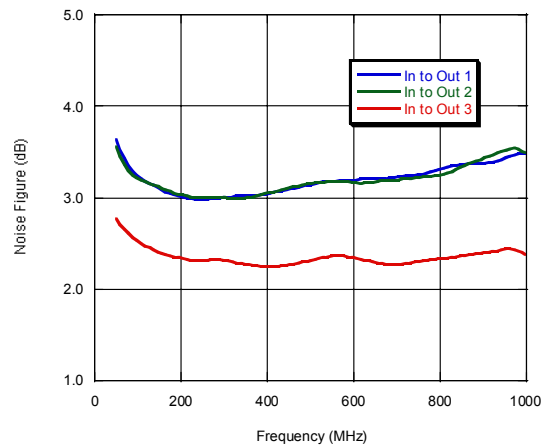

In – Out 2

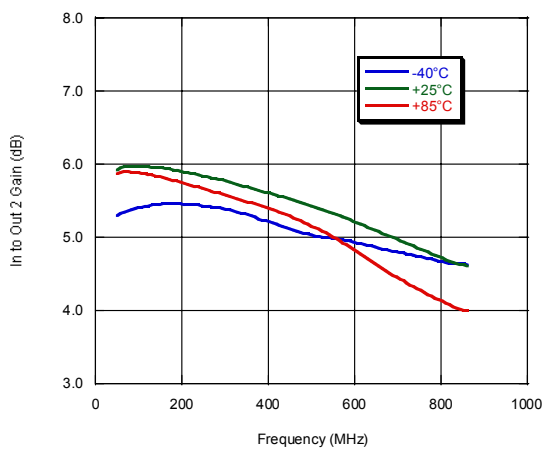

Isolation

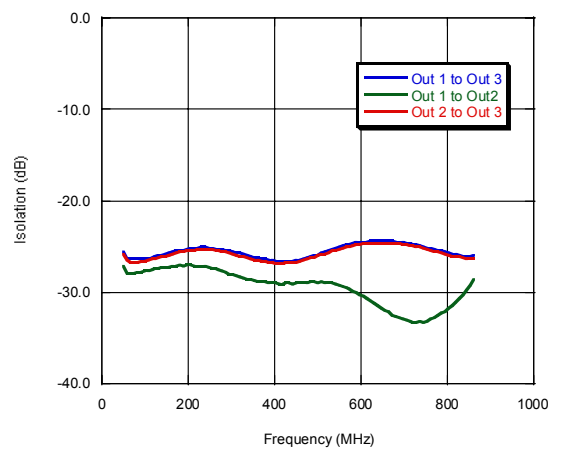

In – Out 3

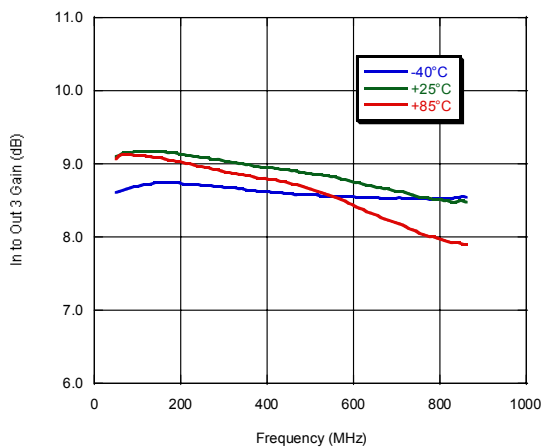

M/A-COM Inc. and its affiliates reserve the right to make changes to the product(s) or information contained herein without notice.

Visit www.macom.com for additional data sheets and product information.

- North America: Tel. (800) 366-2266
- Asia/Pacific: Tel. +81-44-844-8296, Fax +81-44-844-8298
- Europe: Tel. +44 (1908) 574 200, Fax +44 (1908) 574 300

Typical Performance Curves

Input Return Loss

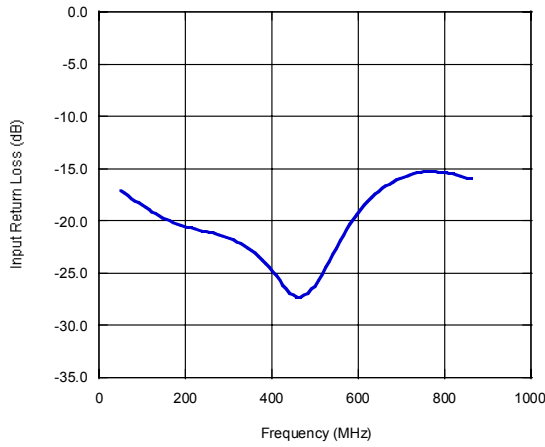

Output Return Loss

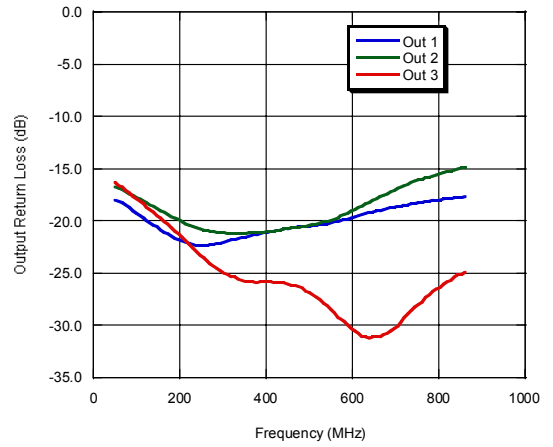

M/A-COM Inc. and its affiliates reserve the right to make changes to the product(s) or information contained herein without notice.

Visit www.macom.com for additional data sheets and product information.

- North America: Tel. (800) 366-2266
- Asia/Pacific: Tel. +81-44-844-8296, Fax +81-44-844-8298
- Europe: Tel. +44 (1908) 574 200, Fax +44 (1908) 574 300