

INTERNATIONAL RECTIFIER

REPETITIVE AVALANCHE RATED AND dv/dt RATED

HEXFET[®] TRANSISTOR IRFV460

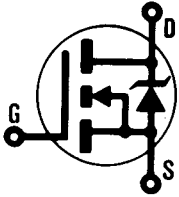

N-CHANNEL

500 Volt, 0.27 Ohm HEXFET

The HEXFET[®] technology is the key to International Rectifier's advanced line of power MOSFET transistors. The efficient geometry design achieves very low on-state resistance combined with high transconductance.

The HEXFET transistors also feature all of the well established advantages of MOSFETs such as voltage control, very fast switching, ease of paralleling and temperature stability of the electrical parameters.

They are well suited for applications such as switching power supplies and virtually any application where military and/or high reliability is required.

Product Summary

Part Number	BV _{DSS}	R _{DS(on)}	I _D
IRFV460	500V	0.27Ω	21A

FEATURES:

- Repetitive Avalanche Rating
- Dynamic dv/dt Rating
- Isolated and Hermetically Sealed
- Alternative to TO-3 Package
- Simple Drive Requirements
- Ease of Paralleling
- Ceramic Eyelets

CASE STYLE AND DIMENSIONS

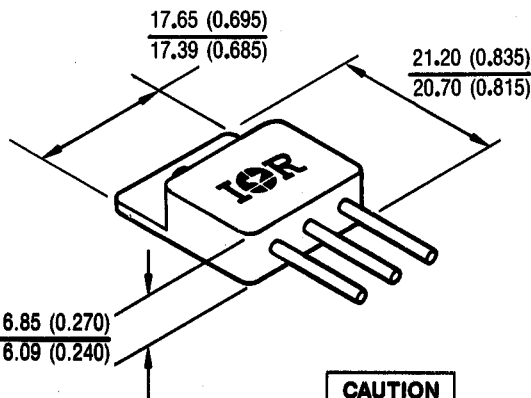

CAUTION

BERYLLIA WARNING PER MIL-S-19500
SEE PAGE I-470

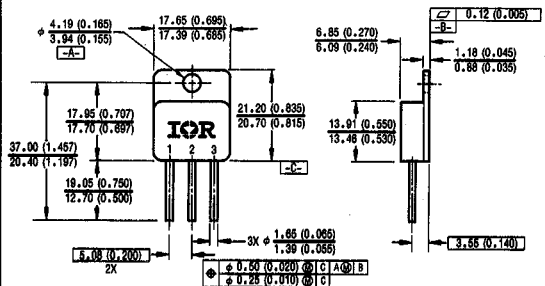

NOTES:

- 1 DIMENSIONING & TOLERANCING PER ANSI Y14.6M - 1982.
- 2 ALL DIMENSIONS ARE SHOWN IN MILLIMETERS (INCHES).

LEGEND

- 1 DRAIN
- 2 SOURCE
- 3 GATE

*For optional leadforms see page I-470, fig. 15

Conforms to JEDEC Outline TO-258AA*
Dimensions in Millimeters and (Inches)

Absolute Maximum Ratings

Parameter		IRFV460	Units
I_D @ $V_{GS} = 0V, T_C = 25^\circ C$	Continuous Drain Current	21	A
I_D @ $V_{GS} = 0V, T_C = 100^\circ C$	Continuous Drain Current	13	
I_{DM}	Pulsed Drain Current ①	84	
P_D @ $T_C = 25^\circ C$	Max. Power Dissipation	300	W
	Linear Derating Factor	2.4	W/K ⑤
V_{GS}	Gate-to-Source Voltage	± 20	V
E_{AS}	Single Pulse Avalanche Energy ②	480	mJ
I_{AR}	Avalanche Current ①	21	A
E_{AR}	Repetitive Avalanche Energy ①	30	mJ
dv/dt	Peak Diode Recovery dv/dt ③	3.5	V/ns
T_J	Operating Junction	-55 to 150	°C
T_{STG}	Storage Temperature Range		
	Lead Temperature	300 (0.063 in. (1.6 mm) from case for 10s)	
	Weight	10.9 (typical)	g

Electrical Characteristics @ $T_J = 25^\circ C$ (Unless Otherwise Specified)

Parameter	Min.	Typ.	Max.	Units	Test Conditions
BV_{DSS}	500	—	—	V	$V_{GS} = 0V, I_D = 1.0 mA$
$\Delta BV_{DSS}/\Delta T_J$	—	0.63	—	V/°C	Reference to 25°C, $I_D = 1.0 mA$
$R_{DS(on)}$	—	—	0.27	Ω	$V_{GS} = 10V, I_D = 13A$ ④
	—	—	0.31		$V_{GS} = 10V, I_D = 21A$
$V_{GS(th)}$	2.0	—	4.0	V	$V_{DS} = V_{GS}, I_D = 250 \mu A$
g_{fs}	13	—	—	S (Ω)	$V_{DS} = 15V, I_{DS} = 13A$ ④
I_{DSS}	—	—	25	μA	$V_{DS} = \text{Max. Rating}, V_{GS} = 0V$
	—	—	250		$V_{DS} = 0.8 \times \text{Max. Rating}$ $V_{GS} = 0V, T_J = 125^\circ C$
I_{GSS}	—	—	100	nA	$V_{GS} = 20V$
I_{GSS}	—	—	-100		$V_{GS} = -20V$
Q_g	—	—	190	nC	$V_{GS} = 10V, I_D = 21A$
Q_{gs}	—	—	27		$V_{DS} = 0.5 \times \text{Max. Rating}$
Q_{gd}	—	—	135		See Fig. 6 and 14
$t_d(on)$	—	—	35	ns	$V_{DD} = 250V, I_D = 21A, R_G = 2.350$
t_r	—	—	120		
$t_d(off)$	—	—	130		See Fig. 11
t_f	—	—	98		
L_D	—	8.7	—	nH	Measured from the drain lead, 6 mm (0.25 in.) from package to center of die.
L_S	—	8.7	—		Measured from the source lead, 6 mm (0.25 in.) from package to source bonding pad.
C_{iss}	—	4300	—	pF	$V_{GS} = 0V, V_{DS} = 25V$
C_{oss}	—	1000	—		$f = 1.0 MHz$
C_{rss}	—	250	—		See Fig. 5

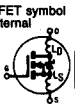

Source-Drain Diode Ratings and Characteristics

Parameter		Min.	Typ.	Max.	Units	Test Conditions
I_S	Continuous Source Current (Body Diode)	—	—	21	A	Modified MOSFET symbol showing the integral Reverse p-n junction rectifier. 
I_{SM}	Pulsed Source Current (Body Diode) ①	—	—	84		
V_{SD}	Diode Forward Voltage	—	—	1.8	V	$T_J = 25^\circ\text{C}$, $I_S = 21\text{A}$, $V_{GS} = 0\text{V}$ ④
t_{rr}	Reverse Recovery Time	—	—	580	nS	$T_J = 25^\circ\text{C}$, $I_F = 21\text{A}$, $di/dt \leq 100\text{ A}/\mu\text{s}$ ④
Q_{RR}	Reverse Recovery Charge	—	—	8.1	μC	$V_{DD} \leq 50\text{V}$
t_{on}	Forward Turn-On Time	Intrinsic turn-on time is negligible. Turn-on speed is substantially controlled by $L_S + L_D$.				

Thermal Resistance

Parameter		Min.	Typ.	Max.	Units	Test Conditions
R_{thJC}	Junction-to-Case	—	—	0.42	K/W ⑤	
R_{thCS}	Case-to-Sink	—	0.21	—		Mounting surface flat, smooth, and greased
R_{thJA}	Junction-to-Ambient	—	—	30		Typical socket mount

① Repetitive Rating; Pulse width limited by maximum junction temperature (see figure 9) Refer to current HEXFET reliability report

② @ $V_{DD} = 50\text{V}$, Starting $T_J = 25^\circ\text{C}$, $L \geq 2.0\text{ mH}$, $R_G = 25\Omega$, Peak $I_L = 21\text{A}$

③ $I_{SD} \leq 21\text{A}$, $di/dt \leq 160\text{ A}/\mu\text{s}$, $V_{DD} \leq BV_{DSS}$, $T_J \leq 150^\circ\text{C}$
Suggested $R_G = 2.35\Omega$

④ Pulse width $\leq 300\ \mu\text{s}$; Duty Cycle $\leq 2\%$

⑤ K/W = $^\circ\text{C}/\text{W}$
W/K = $\text{W}/^\circ\text{C}$

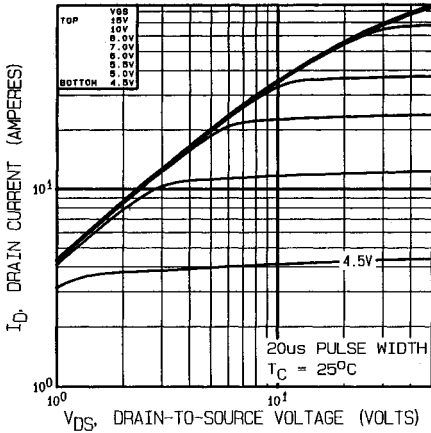

Fig. 1 — Typical Output Characteristics, $T_C = 25^\circ\text{C}$

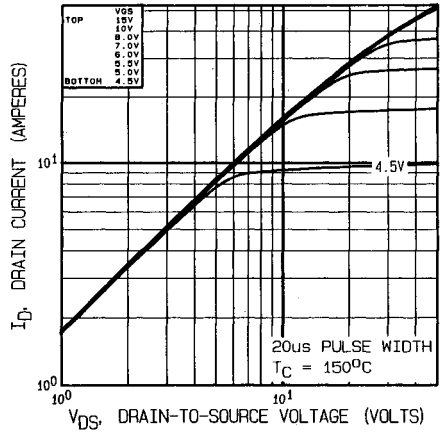

Fig. 2 — Typical Output Characteristics, $T_C = 150^\circ\text{C}$

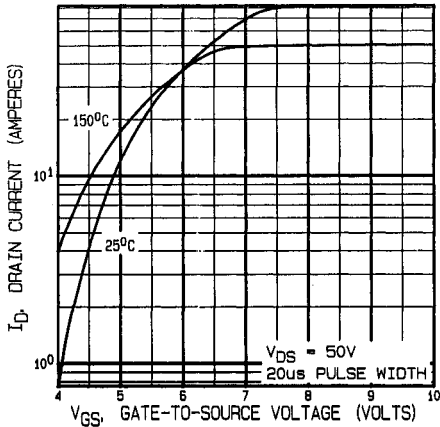

Fig. 3 — Typical Transfer Characteristics

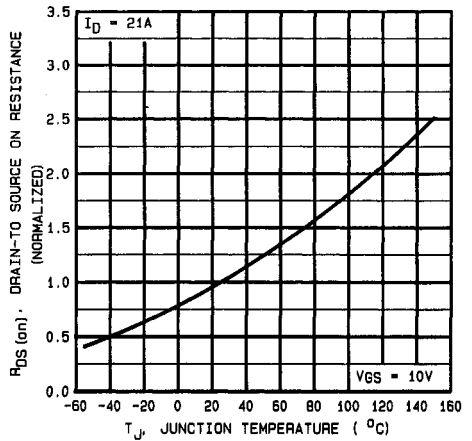
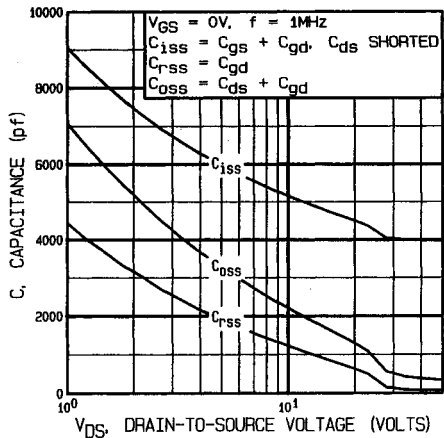
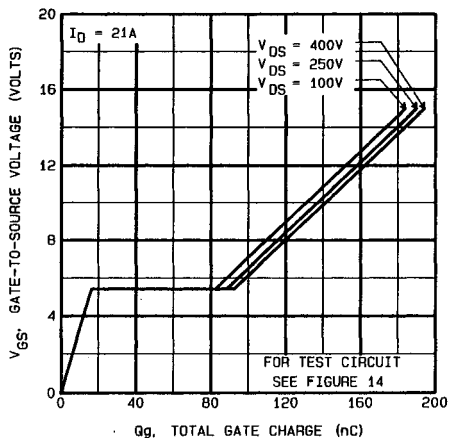
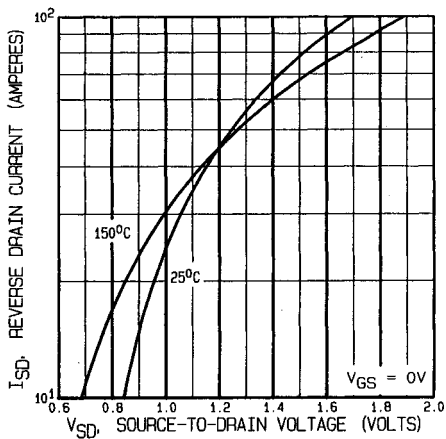
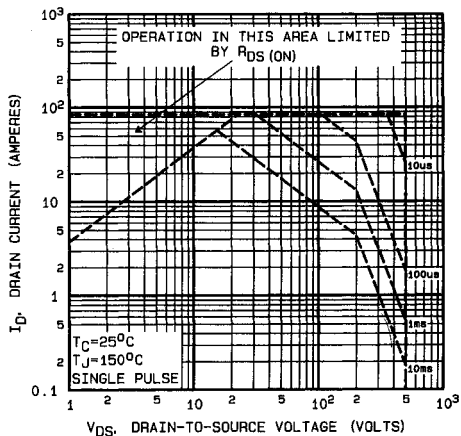

Fig. 4 — Normalized On-Resistance Vs. Temperature

Fig. 5 -- Typical Capacitance Vs. Drain-to-Source Voltage

Fig. 6 -- Typical Gate Charge Vs. Gate-to-Source Voltage

Fig. 7 -- Typical Source-Drain Diode Forward Voltage

Fig. 8 -- Maximum Safe Operating Area

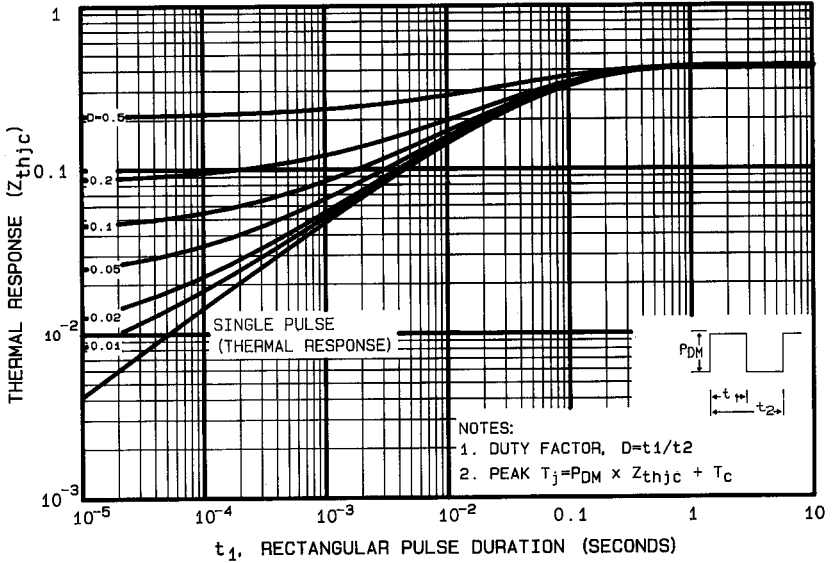

Fig. 9 — Maximum Effective Transient Thermal Impedance, Junction-to-Case Vs. Pulse Duration

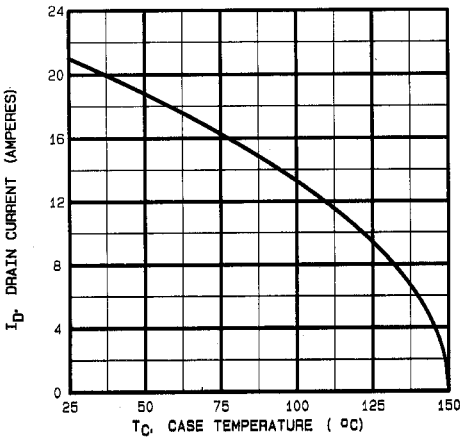

Fig. 10 — Maximum Drain Current Vs. Case Temperature

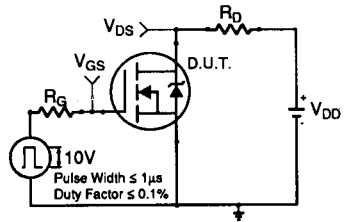

Fig. 11a — Switching Time Test Circuit

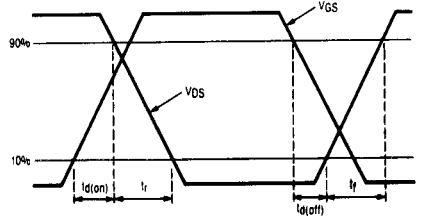
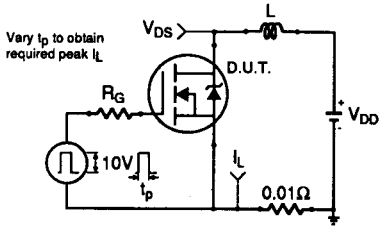
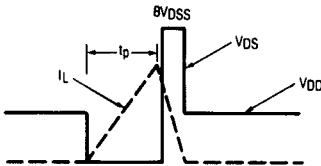
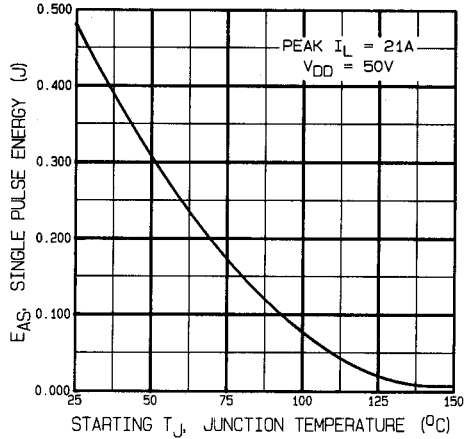
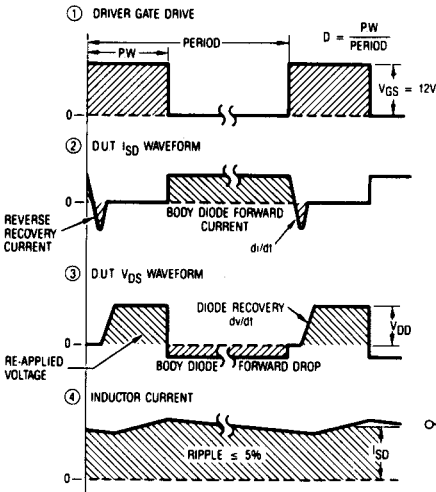
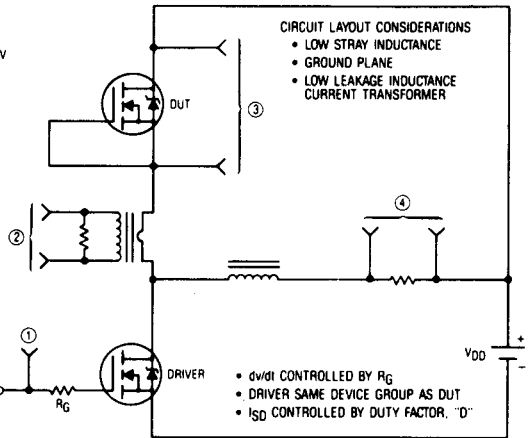

Fig. 11b — Switching Time Waveforms

Fig. 12a — Unclamped Inductive Test Circuit

Fig. 12b — Unclamped Inductive Waveforms

Fig. 12c — Maximum Avalanche Energy Vs. Starting Junction Temperature

Fig. 13 — Peak Diode Recovery dv/dt Test Circuit

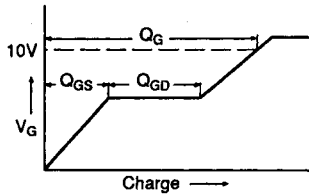

Fig. 14a — Basic Gate Charge Waveform

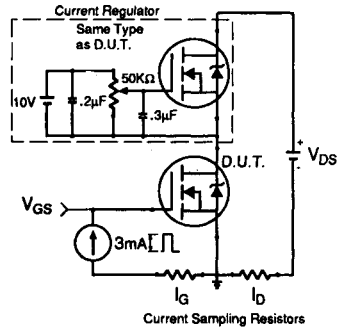

Fig. 14b — Gate Charge Test Circuit

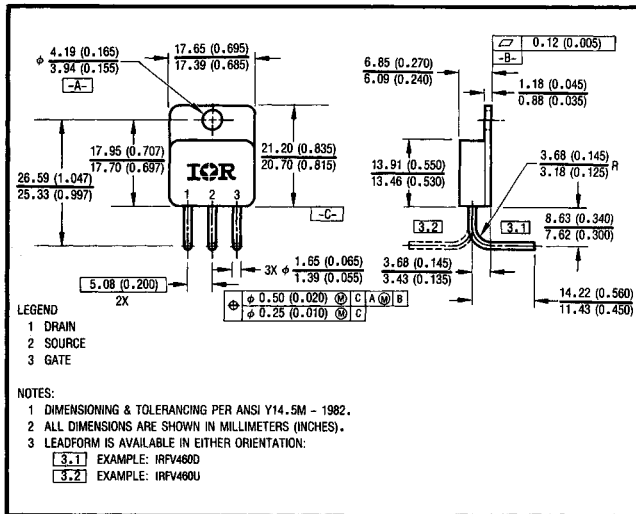

Fig. 15 — Optional Leadforms for Outline TO-258

BERYLLIA WARNING PER MIL-S-19500

Packages containing beryllia shall not be ground, sandblasted, machined, or have other operations performed on them which will produce beryllia or beryllium dust. Furthermore, beryllium oxide packages shall not be placed in acids that will produce fumes containing beryllium.



IRFY Series Data Sheet

The IRFY Data Sheet describes 12 devices, 8 N-Channel and 4 P-Channel, all contained in the TO-257AB package. This data sheet is arranged to show common tabular and graphical information between devices.

Absolute maximum ratings and parametric data are presented in tabular format with devices grouped according to generically shared parameters. For each parametric rating, devices are categorized by N and P channel and listed in alpha-numeric order. The conditions specified for a given parametric test are provided in the right hand column of each table.

Graphical information is grouped by devices in

alphabetical order. Where the information is device specific, we have assigned a numeric character for the graph type and an alpha character to a given device. (See Table A below). Where graphs are polarity specific as in figures 10, 12, 14 and 15, we have indicated N-Channel or P-Channel. The Thermal Impedance Graph (Fig. 11) is the only exception where a graph is common to both N-Channel and P-Channel devices since the thermal impedance is only dependent on the die size and package.

In Table A below, a legend is provided cross referencing the part number to its assigned alpha code. A given device will retain this alpha code for each device specific graph.

Table A

DEVICE	ALPHA DESIGNATION
IRFY044	a
IRFY120	b
IRFY130	c
IRFY140	d
IRFY240	e
IRFY340	f
IRFY430	g
IRFY440	h
IRFY9120	i
IRFY9130	j
IRFY9140	k
IRFY9240	l

IRFF Series Devices



HEXFET, CECC Qualified — Europe

TO257/HEXFET/N-Channel

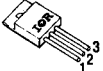
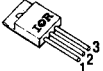
Basic Type	V _{DS} (V)	R _{DS(on)} (Ohms)	CECC Specification	Issue No.	Issue Date	Level of Quality Assessment and CECC 50 000 Screen Level Options	Case Outline												
IRFY044(M)	60	0.03	50 012-062	1	10/91	E-,EA,EB,EC,ED	TO-257AA Y-PAK 												
IRFY120(M)	100	0.31	50 012-060			E-,EA,EB,EC,ED													
IRFY130(M)	100	0.19	50 012-061			E-,EA,EB,EC,ED													
IRFY140(M)	100	0.092	50 012-062			E-,EA,EB,EC,ED													
IRFY240(M)	200	0.19	50 012-062			E-,EA,EB,EC,ED													
IRFY340(M)	400	0.55	50 012-062			E-,EA,EB,EC,ED													
IRFY430(M)	500	1.50	50 012-061			E-,EA,EB,EC,ED													
IRFY440(M)	500	0.85	50 012-062			E-,EA,EB,EC,ED													
TO257/HEXFET/P-Channel								 <table border="1" data-bbox="806 445 936 501"> <tr> <td></td> <td>1</td> <td>2</td> <td>3</td> </tr> <tr> <td>IRFY</td> <td>G</td> <td>D</td> <td>S</td> </tr> <tr> <td>IRFY(M)</td> <td>D</td> <td>S</td> <td>G</td> </tr> </table>		1	2	3	IRFY	G	D	S	IRFY(M)	D	S
	1	2	3																
IRFY	G	D	S																
IRFY(M)	D	S	G																
IRFY9120(M)	-100	0.60	50 012-063	1	10/91	E-,EA,EB,EC,ED													
IRFY9130(M)	-100	0.31	50 012-064			E-,EA,EB,EC,ED													
IRFY9140(M)	-100	0.21	50 012-065			E-,EA,EB,EC,ED													
IRFY9240(M)	-200	0.50	50 012-065			E-,EA,EB,EC,ED													
						E-,EA,EB,EC,ED													

FOR OTHER GOVERNMENT/SPACE QUALIFIED PRODUCTS SEE SECTION E.