

# 2 – 26.5 Medium Power Amplifier

## Technical Data

### HMMC-5027

#### Features

- **Wide-Frequency Range:**  
2-26.5 GHz
- **Moderate Gain:** 7 dB
- **Gain Flatness:** 1 dB
- **Return Loss:**  
Input -13 dB  
Output -11 dB
- **Low-Frequency Operation Capability:** < 2 GHz
- **Gain Control:**  
30 dB Dynamic Range
- **Medium Power:**  
20 GHz: P<sub>-1dB</sub>: 22 dBm  
P<sub>sat</sub>: 24 dBm  
26.5 GHz: P<sub>-1dB</sub>: 19 dBm  
P<sub>sat</sub>: 21 dBm

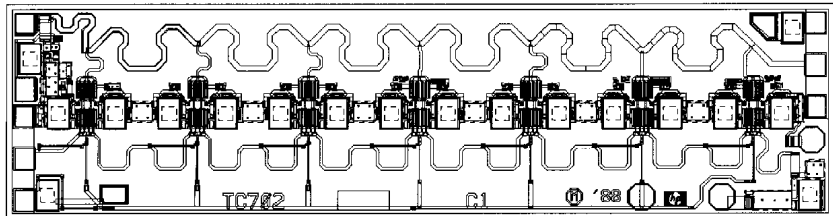

Chip Size: 2980 x 770  $\mu\text{m}$  (117.3 x 30.3 mils)  
 Chip Size Tolerance:  $\pm 10 \mu\text{m}$  ( $\pm 0.4$  mils)  
 Chip Thickness:  $127 \pm 15 \mu\text{m}$  ( $5.0 \pm 0.6$  mils)  
 Pad Dimensions: 75 x 75  $\mu\text{m}$  (2.95 x 2.95 mils), or larger

#### Absolute Maximum Ratings<sup>[1]</sup>

Symbol	Parameters/Conditions	Units	Min.	Max.
V <sub>DD</sub>	Positive Drain Voltage	V		8.0
I <sub>DD</sub>	Total Drain Current	mA		300
V <sub>G1</sub>	First Gate Voltage	V	-5	0
I <sub>G1</sub>	First Gate Current	mA	-1	+1
V <sub>G2</sub>	Second Gate Voltage	V	-2.5	+5
I <sub>G2</sub>	Second Gate Current	mA	-25	
P <sub>DC</sub>	DC Power Dissipation	watts		2.4
P <sub>in</sub>	CW Input Power	dBm		23
T <sub>ch</sub>	Operating Channel Temp.	°C		+150
T <sub>case</sub>	Operating Case Temp.	°C	-55	
T <sub>STG</sub>	Storage Temperature	°C	-65	+165
T <sub>max</sub>	Maximum Assembly Temp. (for 60 seconds maximum)	°C		+300

#### Note:

1. Operation in excess of any one of these conditions may result in permanent damage to this device. T<sub>A</sub> = 25°C except for T<sub>ch</sub>, T<sub>STG</sub>, and T<sub>max</sub>.

#### Description

The HMMC-5027 is a broadband GaAs MMIC Traveling Wave Amplifier designed for medium output power and moderate gain over the full 2 to 26.5 GHz frequency range. Seven MESFET cascode stages provide a flat gain response, making the HMMC-5027 an ideal wideband power block. Optical lithography is used to produce gate lengths of  $\approx 0.5 \mu\text{m}$ . The HMMC-5027 incorporates advanced MBE technology, Ti-Pt-Au gate metallization, silicon nitride passivation, and polyimide for scratch protection.

## HMMC-5027 DC Specifications/Physical Properties <sup>[1]</sup>

Symbol	Parameters and Test Conditions	Units	Min.	Typ.	Max.
$I_{DSS}$	Saturated Drain Current ( $V_{DD} = 8.0\text{ V}$ , $V_{G1} = 0.0\text{ V}$ , $V_{G2} = \text{open circuit}$ )	mA	200	300	500
$V_p$	First Gate Pinch-off Voltage ( $V_{DD} = 8.0\text{ V}$ , $I_{DD} = 30\text{ mA}$ , $V_{G2} = \text{open circuit}$ )	V	-2.2	-1.3	-5
$V_{G2}$	Second Gate Self-Bias Voltage ( $V_{DD} = 8.0\text{ V}$ , $V_{G1} = 0.0\text{ V}$ )	V		1.8 ( $0.27 \times V_{DD}$ )	
$I_{DSOFF}(V_{G1})$	First Gate Pinch-off Current ( $V_{DD} = 8.0\text{ V}$ , $V_{G1} = -3.5\text{ V}$ , $V_{G2} = \text{open circuit}$ )	mA		7	
$I_{DSOFF}(V_{G2})$	Second Gate Pinch-off Current ( $V_{DD} = 5.0\text{ V}$ , $V_{G1} = 0.0\text{ V}$ , $V_{G2} = -3.5\text{ V}$ )	mA		10	
$\theta_{ch-bs}$	Thermal Resistance ( $T_{backside} = 25^\circ\text{C}$ )	$^\circ\text{C}/\text{W}$		28	

**Note:**

1. Measured in wafer form with  $T_{chuck} = 25^\circ\text{C}$ . (Except  $\theta_{ch-bs}$ .)

## HMMC-5027 RF Specifications<sup>[1]</sup>,

$T_{op} = 25^\circ\text{C}$ ,  $V_{D1} = V_{D2} = 5\text{ V}$ ,  $V_{G1} = V_{G2} = \text{Open}$ ,  $Z_0 = 50\ \Omega$ , unless otherwise noted

Symbol	Parameters and Test Conditions	Units	Min.	Typ.	Max.
BW	Guaranteed Bandwidth <sup>[2]</sup>	GHz	2		26.5
$S_{21}$	Small Signal Gain	dB	6	7	
$\Delta S_{21}$	Small Signal Gain Flatness	dB		$\pm 0.8$	
$RL_{in}$	Input Return Loss	dB		-13	-10
$RL_{out}$	Output Return Loss	dB		-11	-10
$S_{12}$	Reverse Isolation	dB		-28	-25
$P_{-1dB}$	Output Power @ 1dB Gain Compression	dBm	16.5	19	
$P_{sat}$	Saturated Output Power	dBm	18.5	21	
$H_2$	Second Harmonic Power Level ( $2 < f_o < 20$ ) [ $P_o(f_o) = 21\text{ dBm}$ or $P_{-1dB}$ , whichever is less]	dBc		-21	-18
$H_3$	Third Harmonic Power Level ( $2 < f_o < 20$ ) [ $P_o(f_o) = 21\text{ dBm}$ or $P_{-1dB}$ , whichever is less]	dBc		-32	-18
NF	Noise Figure	dB		11	

**Notes:**

1. Small-signal data measured in wafer form with  $T_{chuck} = 25^\circ\text{C}$ . Large-signal data measured on individual devices mounted in an HP83040 Series Modular Microcircuit Package at  $T_A = 25^\circ\text{C}$ .
2. Performance may be extended to lower frequencies through the use of appropriate off-chip circuitry. Upper corner frequency  $\sim 30\text{ GHz}$ .

## HMMC-5027 Applications

The HMMC-5027 series of traveling wave amplifiers are designed for use as general purpose wideband power stages in communication systems and microwave instrumentation. They are ideally suited for broadband applications requiring a flat gain response and excellent port matches over a 2 to 26.5 GHz frequency range. Dynamic gain control and low-frequency extension capabilities are designed into these devices.

## Biasing and Operation

These amplifiers are biased with a single positive drain supply ( $V_{DD}$ ) and a single negative gate supply ( $V_{G1}$ ). The recommended bias conditions for the HMMC-5027 are  $V_{DD} = 8.0V$ ,  $I_{DD} = 250\text{ mA}$  or  $I_{DSS}$ , whichever is less. To achieve this drain current level,  $V_{G1}$  is typically biased between 0V and -0.6V. No other

bias supplies or connections to the device are required for 2 to 26.5 GHz operation. The gate voltage ( $V_{G1}$ ) MUST be applied prior to the drain voltage ( $V_{DD}$ ) during power up and removed after the drain voltage during power down. See Figure 3 for assembly information.

The auxiliary gate and drain contacts are used only for low-frequency performance extension below  $\approx 1.0\text{ GHz}$ . When used, these contacts must be AC coupled only. (Do not attempt to apply bias to these pads.) The second gate ( $V_{G2}$ ) can be used to obtain 30 dB (typical) dynamic gain control. For normal operation, no external bias is required on this contact and its self-bias potential is between +1.5 and +2.5 volts. Applying an external bias between its open circuit potential and -2.5 volts will adjust the gain while maintaining a good input/output port match.

## Assembly Techniques

Solder die-attach using a fluxless AuSu solder preform is the recommended assembly method. Gold thermosonic wedge bonding with 0.7 mil diameter Au wire is recommended for all bonds. Tool force should be  $22 \pm 1$  gram, stage temperature should be  $150 \pm 2^\circ\text{C}$ , and ultrasonic power and duration should be  $64 \pm 1\text{ dB}$  and  $76 \pm 8\text{ msec}$ , respectively. The bonding pad and chip backside metallization is gold.

For more detailed information see HP application note #999 "GaAs MMIC Assembly and Handling Guidelines."

---

*GaAs MMICs are ESD sensitive. Proper precautions should be used when handling these devices.*

---

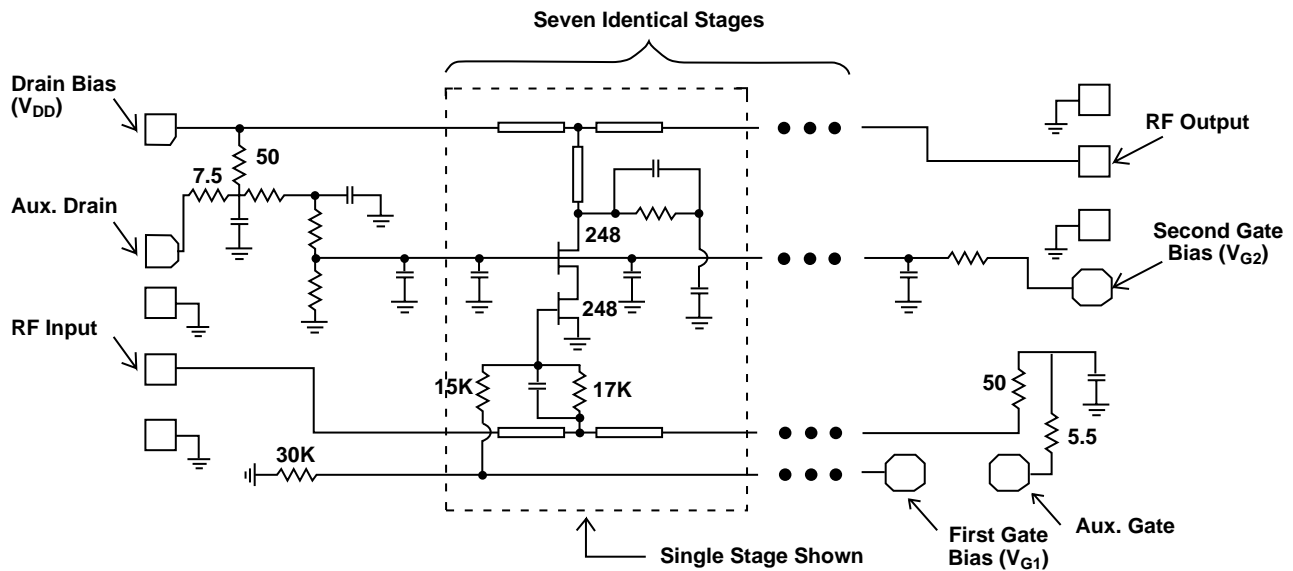

Figure 1. HMMC-5027 Schematic.

**Notes:**  
 FET gate periphery in microns.  
 All resistors in ohms. ( $\Omega$ ),  
 (or in K-ohms, where indicated)

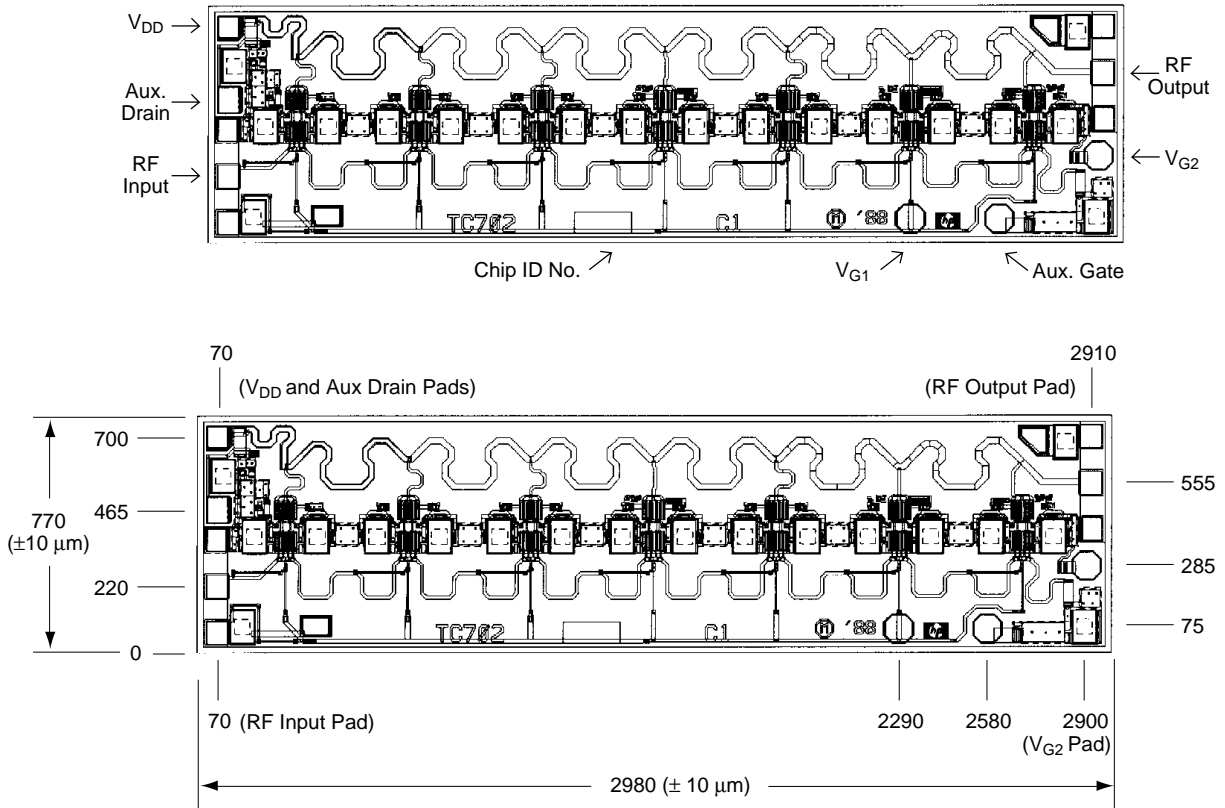

Figure 2. HMMC-5027 Bonding Pad Locations.

**Notes:**  
 All dimensions in microns.  
 Rectangular Pad Dim: 75 x 75 μm.  
 Octagonal Pad Dim: 90 μm dia.  
 All other dimensions ±5 μm (unless otherwise noted).  
 Chip thickness: 127 ± 15 μm.

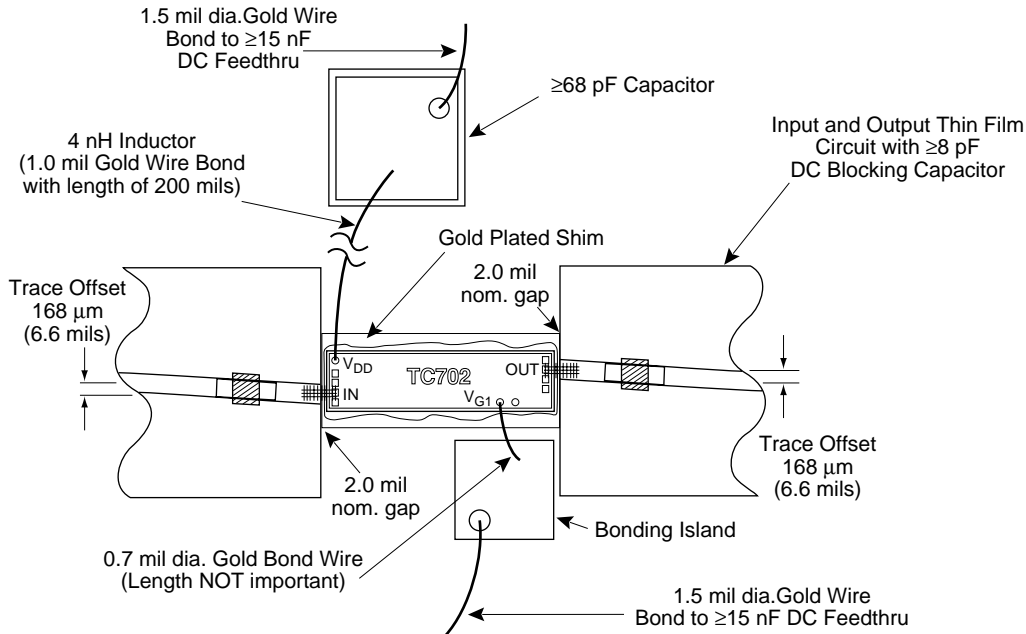

Figure 3. HMMC-5027 Assembly Diagram.

**Note:**  
 Total offset between RF input and RF output pad is 335 μm (13.2 mils).

## HMMC-5027 Typical Performance

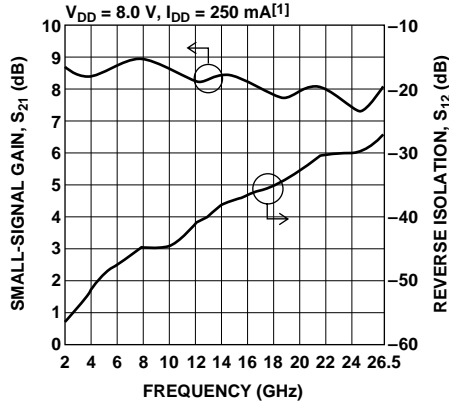

Figure 4. Typical Gain and Reverse Isolation vs. Frequency.

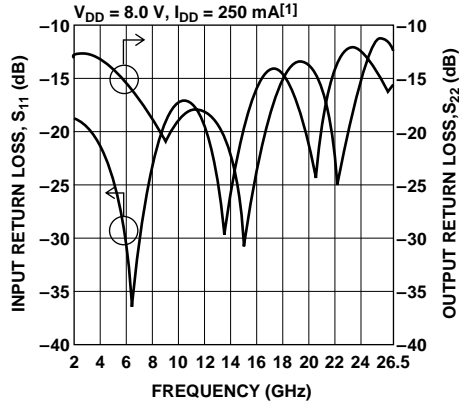

Figure 5. Typical Input and Output Return Loss vs. Frequency.

## Typical Scattering Parameters<sup>[1]</sup>,

( $T_{\text{chuck}} = 25^{\circ}\text{C}$ ,  $V_{\text{DD}} = 8.0\text{ V}$ ,  $I_{\text{DD}} = 250\text{ mA}$  or  $I_{\text{DSS}}$ , whichever is less,  $Z_{\text{in}} = Z_{\text{o}} = 50\ \Omega$ )

Freq. GHz	$S_{11}$			$S_{21}$			$S_{12}$			$S_{22}$		
	dB	Mag	Ang	dB	Mag	Ang	dB	Mag	Ang	dB	Mag	Ang
2.0	-18.7	0.116	-139.5	-57.7	0.0013	-165.2	8.7	2.717	116.6	-13.0	0.223	173.5
3.0	-20.1	0.099	-159.0	-54.9	0.0018	144.2	8.4	2.635	94.8	-13.0	0.224	150.0
4.0	-21.5	0.084	-175.7	-52.0	0.0025	154.0	8.3	2.612	72.0	-13.5	0.212	127.1
5.0	-24.6	0.059	167.8	-49.9	0.0032	111.3	8.4	2.634	48.2	-14.0	0.200	101.6
6.0	-32.0	0.025	167.4	-48.2	0.0039	91.3	8.6	2.699	23.3	-15.3	0.171	71.7
7.0	-30.8	0.029	-94.8	-46.9	0.0045	74.9	8.8	2.763	-3.5	-16.9	0.143	39.5
8.0	-22.7	0.073	-103.2	-45.5	0.0053	21.0	8.8	2.768	-30.9	-18.4	0.120	-2.2
9.0	-18.9	0.114	-121.5	-45.2	0.0055	10.3	8.8	2.744	-58.9	-21.3	0.086	-46.9
10.0	-17.2	0.137	-142.6	-44.7	0.0058	-15.5	8.5	2.673	-85.9	-18.9	0.114	-90.7
11.0	-17.4	0.135	-163.9	-43.5	0.0067	-33.4	8.3	2.608	-112.5	-17.9	0.127	-129.6
12.0	-19.3	0.108	175.6	-41.5	0.0084	-45.4	8.2	2.564	-138.5	-18.2	0.123	-162.6
13.0	-25.6	0.052	170.3	-40.6	0.0093	-75.8	8.2	2.578	-164.9	-19.3	0.108	163.4
14.0	-27.0	0.045	-113.0	-38.6	0.0118	-95.9	8.3	2.610	167.1	-22.1	0.078	126.5
15.0	-19.2	0.109	-111.0	-37.8	0.0129	-124.7	8.3	2.605	138.4	-31.2	0.028	56.7
16.0	-15.6	0.167	-127.9	-37.1	0.0139	-149.1	8.2	2.574	108.8	-23.5	0.067	-33.3
17.0	-14.3	0.193	-148.4	-36.3	0.0153	-174.5	8.0	2.510	79.7	-18.1	0.124	-80.7
18.0	-14.8	0.182	-166.6	-35.8	0.0163	164.1	7.8	2.444	50.9	-15.2	0.174	-115.2
19.0	-17.1	0.140	-179.3	-34.7	0.0185	141.5	7.7	2.418	22.1	-13.7	0.207	-147.6
20.0	-21.4	0.086	-166.2	-32.9	0.0227	112.6	7.8	2.466	-7.5	-13.9	0.202	177.9
21.0	-18.4	0.121	-129.5	-31.6	0.0262	80.7	8.1	2.527	-39.9	-16.8	0.145	136.7
22.0	-13.8	0.205	-137.2	-30.9	0.0285	42.7	8.0	2.512	-74.0	-25.3	0.054	66.9
23.0	-12.1	0.247	-152.7	-30.6	0.0296	13.3	7.6	2.395	-108.4	-19.8	0.102	-56.2
24.0	-12.3	0.244	-169.8	-30.3	0.0304	-15.5	7.4	2.344	-142.5	-13.7	0.207	-103.5
25.0	-14.7	0.184	-175.8	-29.7	0.0329	-44.9	7.3	2.315	-175.6	-11.3	0.272	-136.7
26.0	-16.7	0.146	-149.3	-28.5	0.0375	-78.1	7.9	2.469	148.1	-11.7	0.259	-171.3
26.5	-14.1	0.197	-141.6	-28.0	0.0399	-98.5	8.0	2.503	126.9	-13.0	0.223	172.3

### Note:

1. Data obtained from on-wafer measurements.

## HMMC-5027 Typical Performance

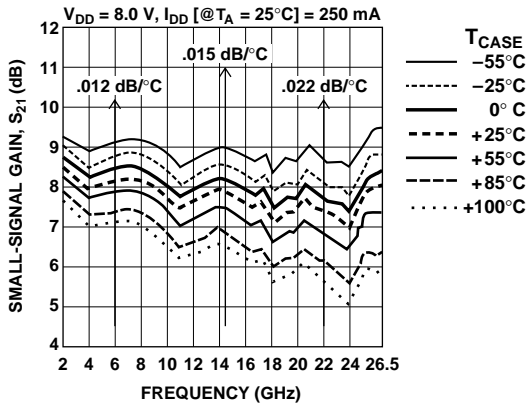

Figure 6. Typical Small-Signal Gain vs. Temperature.

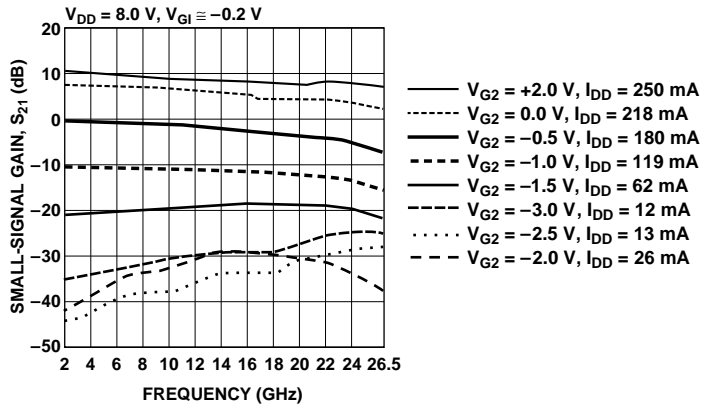

Figure 7. Typical Gain vs. Second Gate Control Voltage.

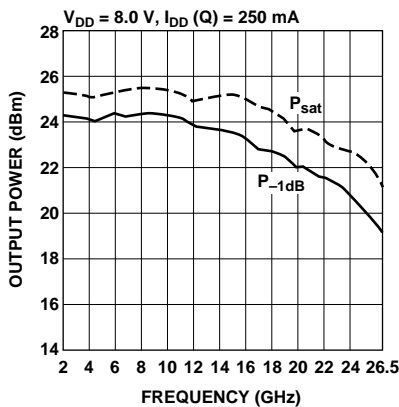

Figure 8. Typical 1 dB Gain Compression and Saturated Output Power vs. Frequency.

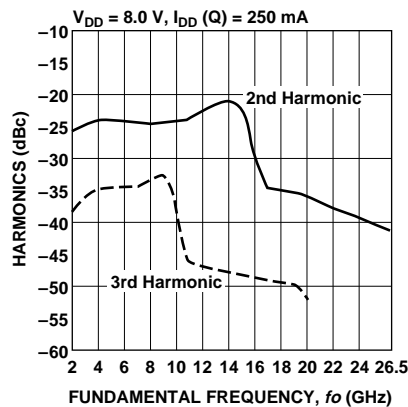

Figure 9. Typical Second and Third Harmonic vs. Fundamental Frequency at  $P_{OUT} = +21$  dBm.

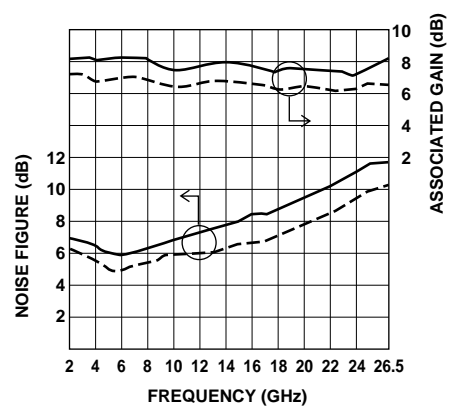

Figure 10. Typical Noise Figure Performance.

— Nominal Bias:  
 $V_{DD} = 8.0$  V,  $I_{DD} = 250$  mA  
 - - - Optimal NF Bias:  
 $V_{DD} = 6.5$  V,  $I_{DD} = 130$  mA

**Note:**

- All data measured on individual devices mounted in an HP83040 Series Modular Microcircuit Package @  $T_A = 25^\circ\text{C}$  (except where noted).

This data sheet contains a variety of typical and guaranteed performance data. The information supplied should not be interpreted as a complete list of circuit specifications. In this data sheet the term *typical* refers to the 50th percentile performance. For additional information contact your local HP sales representative.