

WIDEBAND POWER AMPLIFIER MODULE, 2 - 20 GHz

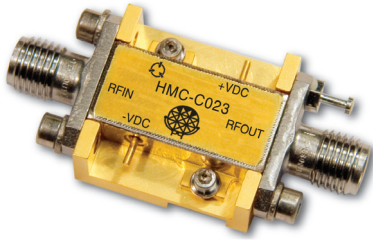

Typical Applications

The HMC-C023 Wideband PA is ideal for:

- Telecom Infrastructure
- Microwave Radio & VSAT
- Military & Space
- Test Instrumentation
- Fiber Optics

Functional Diagram

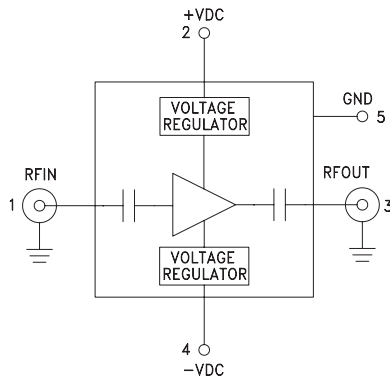

Features

- Gain: 15 dB @ 10 GHz
- P1dB Output Power: +26 dBm @ 10 GHz
- Spurious-Free Operation
- Regulated Supply and Bias Sequencing
- Hermetically Sealed Module
- Field Replaceable SMA connectors
- 55 to +85°C Operating Temperature

General Description

The HMC-C023 is a GaAs MMIC PHEMT Distributed Power Amplifier in a miniature, hermetic module with replaceable SMA connectors which operates between 2 and 20 GHz. The amplifier provides 15 dB of gain, +30 dBm output IP3 and up to +26 dBm of output power at 1 dB gain compression. Gain flatness is excellent from 2 - 16 GHz making the HMC-C023 ideal for EW, ECM RADAR and test equipment applications. The wideband amplifier I/Os are internally matched to 50 Ohms and are DC blocked. Integrated voltage regulators allow for flexible biasing of both the negative and positive supply pins, while internal bias sequencing circuitry assures robust operation.

Electrical Specifications, $T_A = +25^\circ\text{C}$, +VDC = +11V to +16V, -VDC = -3V to -12V

Parameter	Min.	Typ.	Max.	Min.	Typ.	Max.	Min.	Typ.	Max.	Units
Frequency Range	2.0 - 6.0			6.0 - 16.0			16.0 - 20.0			GHz
Gain	13	15		11	14		9	12		dB
Gain Flatness		±0.25			±0.5			±1.0		dB
Gain Variation Over Temperature		0.02	0.03		0.02	0.03		0.02	0.03	dB/°C
Noise Figure		4.0			4.0			6.0		dB
Input Return Loss		17			18			12		dB
Output Return Loss		13			12			10		dB
Output Power for 1 dB Compression (P1dB)	23	26		21	24		19	22		dBm
Saturated Output Power (Psat)		27			25			23		dBm
Output Third Order Intercept (IP3)		34			30			25		dBm
Positive Supply Current (+IDC)		310			310			310		mA
Negative Supply Current (-IDC)		1.7			1.7			1.7		mA

WIDEBAND POWER AMPLIFIER MODULE, 2 - 20 GHz

Gain & Return Loss

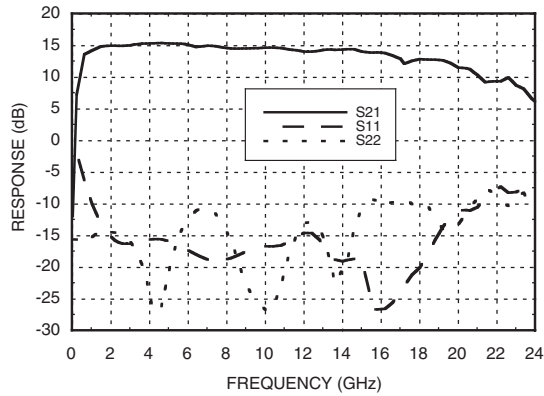

Gain vs. Temperature

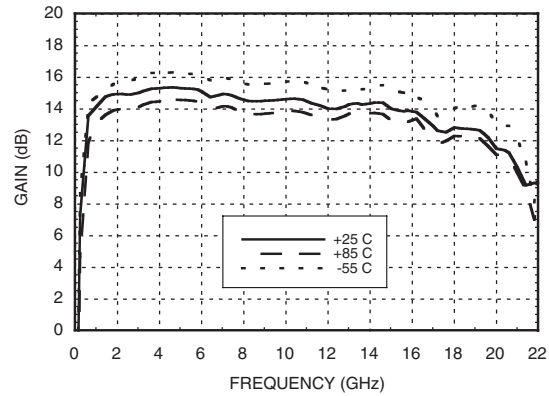

Input Return Loss vs. Temperature

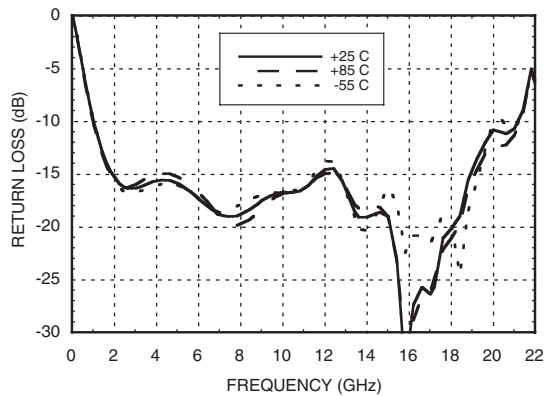

Output Return Loss vs. Temperature

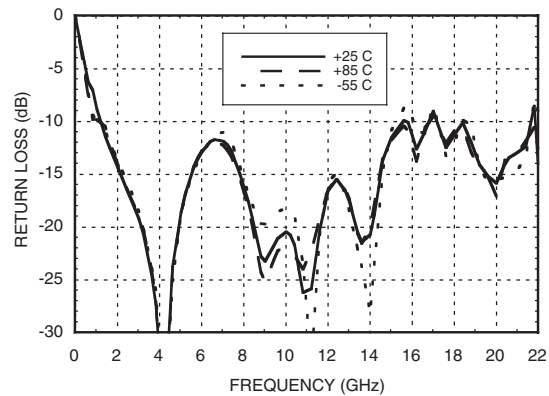

Reverse Isolation vs. Temperature

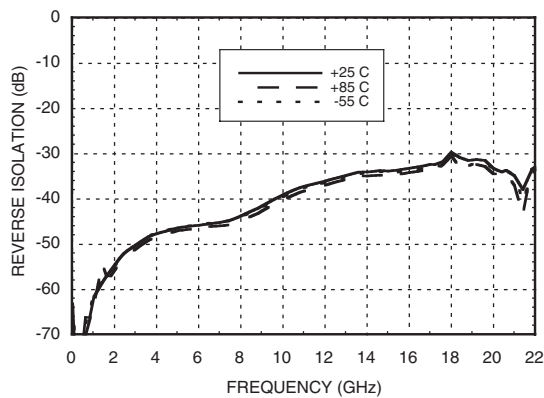

Noise Figure vs. Temperature

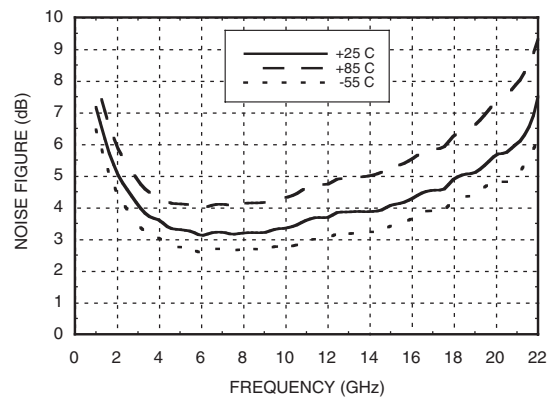

WIDEBAND POWER AMPLIFIER MODULE, 2 - 20 GHz

P1dB vs. Temperature

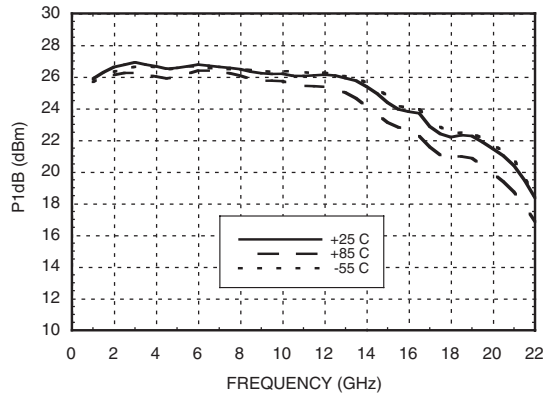

Psat vs. Temperature

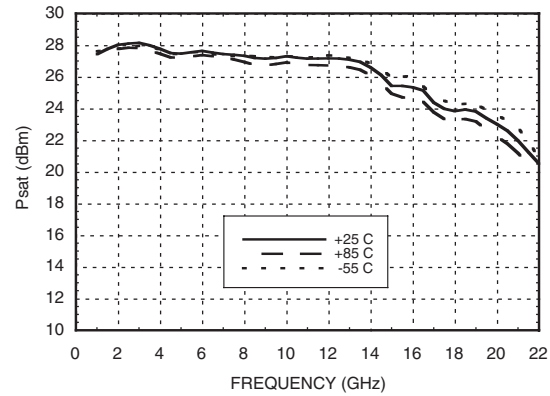

Output IP3 vs. Temperature

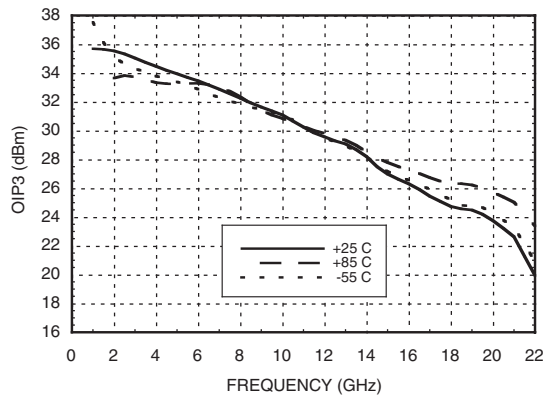

Absolute Maximum Ratings



Positive Bias Supply Voltage (+VDC)	+17V Max
Negative Bias Supply (-VDC)	-16V Min.
RF Input Power (RFIn)	+23 dBm
Storage Temperature	-65 to +150 °C
Operating Temperature	-55 to +85 °C



**ELECTROSTATIC SENSITIVE DEVICE
OBSERVE HANDLING PRECAUTIONS**

**WIDEBAND POWER AMPLIFIER
MODULE, 2 - 20 GHz**

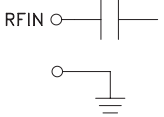
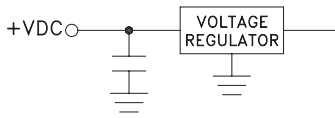
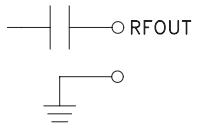
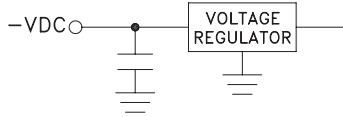
Pin Descriptions

Pin Number	Function	Description	Interface Schematic
1	RFIN & RF Ground	RF input connector, SMA female, field replaceable. This pin is AC coupled and matched to 50 Ohms from 2 - 20 GHz.	
2	+VDC	Positive power supply voltage for the amplifier.	
3	RFOUT & RF Ground	RF output connector, SMA female. This pin is AC coupled and matched to 50 Ohms from 2 - 20 GHz.	
4	-VDC	Negative power supply voltage for the amplifier	
5	GND	Power supply ground.	

WIDEBAND POWER AMPLIFIER MODULE, 2 - 20 GHz

Outline Drawing

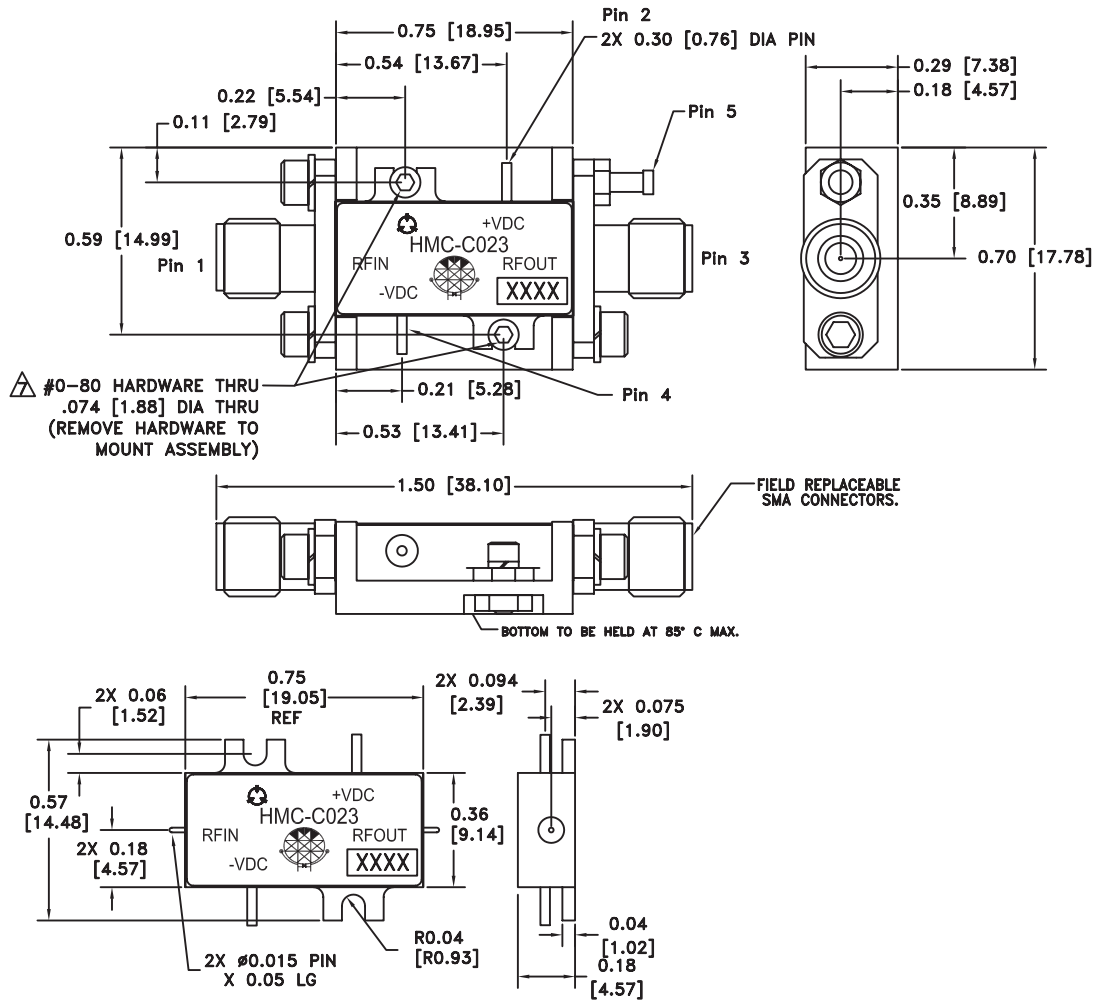

NOTES:

1. PACKAGE, LEADS, COVER MATERIAL: KOVAR™
2. SPACER MATERIAL: ALUMINUM
3. PLATING: ELECTROLYTIC GOLD 50 MICROINCHES MIN., OVER ELECTROLYTIC NICKEL 75 MICROINCHES MIN.
4. ALL DIMENSIONS ARE IN INCHES [MILLIMETERS].
5. TOLERANCES ±.005 [0.13] UNLESS OTHERWISE SPECIFIED.
6. FIELD REPLACEABLE SMA CONNECTORS. TENSOLITE 5602 - 5CCSF OR EQUIVALENT.

△ TO MOUNT MODULE TO SYSTEM PLATFORM REPLACE 0 - 80 HARDWARE WITH DESIRED MOUNTING SCREWS.

**WIDEBAND POWER AMPLIFIER
MODULE, 2 - 20 GHz**

Notes: