

Low-voltage FM IF Amplifier

Description

CXA1183M is a monolithic IC designed for FM communication devices such as cordless tele-phones. It contains among others, a jamming de-tection function, mixer, IF limiter, FM detector and squelch circuit.

Features

- Low operating voltage: (1.8 to 6.0 V)
- Low power consumption: (3.5 mA at 3.6 V)
- Built-in JAM detection function (JAM DET)
- Fewer external parts

Functions

- Mixer
- Local oscillator
- IF limiter
- FM detector
- Squelch circuit
- Receiving Signal Strength Indicator (RSSI)
- Jamming detection (JAM DET)

Structure

Bipolar silicon monolithic IC

Absolute Maximum Ratings (Ta = 25°C)

• Supply voltage	VCC	10	V
• Operating temperature	Topr	- 20 to + 75	°C
• Storage temperature	Tstg	- 55 to + 150	°C

Recommended Operating Conditions

• Supply voltage	VCC	1.8 to 6.0	V
------------------	-----	------------	---

Package Outline

Unit: mm

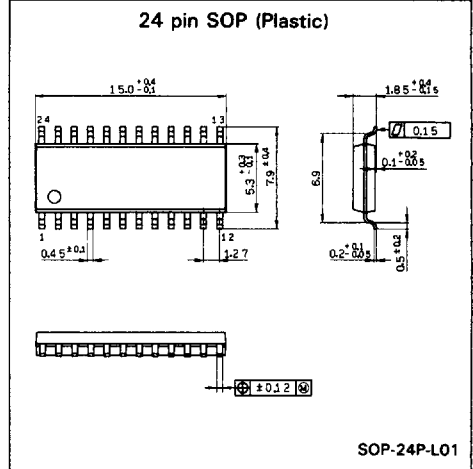

3

Block Diagram and Pin Configuration (Top View)

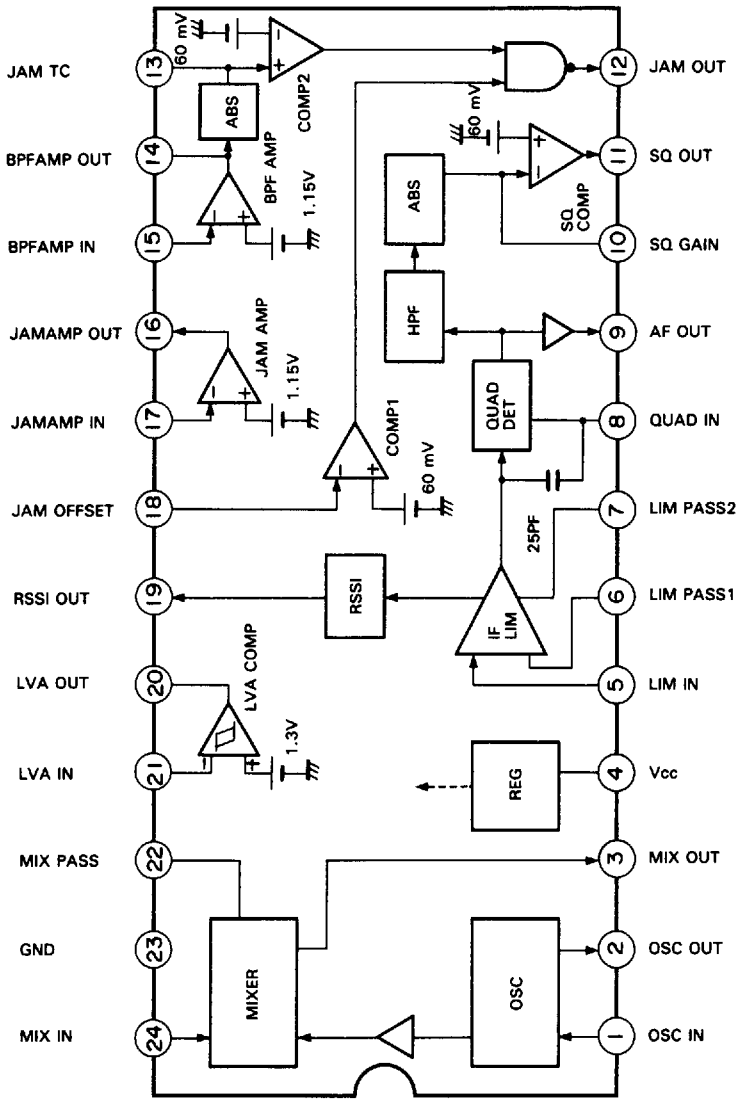

Pin Description and Equivalent Circuit

No.	Symbol	Voltage (Typ.) V	Equivalent circuit	Description
1 2	OSC IN OSC OUT	1.13V 0.42V		Connected to a crystal oscillator to form a Colpitts type oscillating circuit. When an external oscillator is used, connect to pin No. 1.
3	MIX OUT	3.3V		Mixer output pin. As open-collector output, it is connected to a load resistor of 1.5 kΩ.
4	Vcc	3.6V		Supply pin.
5 6 7	LIM IN LIM PASS1 LIM PASS2	2.95V 2.95V 2.95V		Pin 5: Limiter input pin. Pins 6, 7: Bypass capacitor connecting pins.

3

No.	Symbol	Voltage (Typ.) V	Equivalent circuit	Description
8	QUAD IN	3.6V		Connected to a quadrature detector resonance circuit.
9	AF OUT	1.15V		FM detected signals are output.
10	SQ GAIN	0V		Sets the gain and time constant of the squelch circuit.
11	SQ OUT	3.6V		Squelch circuit output pin. Turns to L when AF OUT S/N ratio deteriorates.

No.	Symbol	Voltage (Typ.) V	Equivalent circuit	Description
12	JAM OUT	3.6V		<p>JAM DET output pin. The output turns to "L" when a jamming signal is input.</p>
13	JAM TC	0V		<p>Sets the time constant of JAM DET.</p>
14	BPFAMP OUT	1.15V		<p>Output pin of BPF operational amplifier used in JAM DET.</p>
15	BPFAMP IN	1.15V		<p>Input pin of the BPF operational amplifier used in JAM DET.</p>

3

No.	Symbol	Voltage (Typ.) V	Equivalent circuit	Description
16	JAMAMP OUT	1.15V		Output pin of the operational amplifier, which determines the sensitivity of JAM DET.
17	JAMAMP IN	1.15V		Input pin of the operational amplifier, which determines the sensitivity of JAM DET.
18	JAM OFFSET	0V		Input pin of the comparator, which stops JAM DET when the signal is weak.
19	RSSI OUT	0V		RSSI output pin.

No.	Symbol	Voltage (Typ.) V	Equivalent circuit	Description
20	LVA OUT	0V		Output pin of the low voltage alarm (LVA). Output turns to "H" when Pin 21 voltage goes below 1.3 V.
21	LVA IN			Sets the threshold voltage of LVA comparator.
22 24	MIX PASS MIX IN	1.14V 1.15V		Pin 22 connects mixer bypass capacitor. Pin 24 mixer input pin.
23	GND	0V		Ground pin.

3

Electrical Characteristics

$V_{CC} = 3.6V$, $V_{in} = 60\text{ dB}\mu$, $f_{in} = 10.7\text{ MHz}$
 $f_{osc} = 10.245\text{ MHz}$, $F_{MOD} = 1\text{ kHz}$, $f_{DIV} \pm 3\text{ kHz}$
 $AM_{MOD} = 30\%$ $T_a = 25^\circ\text{C}$

Item	Symbol	Condition	Min.	Typ.	Max.	Unit
Power consumption	I _{CC}	$V_{in} = 0$	2.5	3.5	5.5	mA
Mixer gain	G _{V (MIX)}	$R_L = 1.5\text{ k}\Omega$	16	20	24	dB
Mixer input resistance	R _{IN (MIX)}		2.8	3.5	4.2	k Ω
Input for -3 dB limiting sensitivity	V _{IL (MIX)}		—	—	36	dB μ
IF amplifier input resistance	R _{IN (IF)}		1.2	1.5	1.8	k Ω
Detected output voltage	V _{O (AF)}		70	90	110	mV _{rms}
Detected output current	I _{O (AF)}		120	140	200	μ A
S/N	S/N		26	—	—	dB
Total harmonic distortion ratio	THD		—	1.0	1.5	%
AM rejection ratio	AMRR		35	—	—	dB
RSSI output voltage	VRSSI 1	$V_{IN(IF)} = 30\text{ dB}\mu$	—	521	—	mV
	VRSSI 2	$V_{IN(IF)} = 60\text{ dB}\mu$	460	740	1010	mV
	VRSSI 3	$V_{IN(IF)} = 90\text{ dB}\mu$	0.71	1.03	1.35	V
HPF cut-off frequency	f _{c (SQ)}		7	10	13	kHz
Squelch reference voltage	V _{ref (SQ)}		54	60	78	mV
Squelch low-level output	V _{OL (SQ)}	$I_o = 1\text{ mA}$	—	—	0.2	V
COMP1 reference voltage	V _{ref (JAML)}		54	60	78	mV
COMP2 reference voltage	V _{ref (JAMB)}		54	60	78	mV
COMP1 input bias current	I _{B (JAML)}		—	—	100	nA
COMP2 input bias current	I _{B (JAMB)}		—	—	100	nA
JAM amplifier gain	G _{V (JAM)}		65	85	—	dB
BPF amplifier gain	G _{V (BPF)}		65	85	—	dB
JAM amplifier output current	I _{O (JAM)}		70	100	125	μ A
BPF amplifier output current	I _{O (BPF)}		70	100	125	μ A
JAM amplifier input bias current	I _{B (JAM)}		—	—	100	nA
BPF amplifier input bias current	I _{B (BPF)}		—	—	100	nA
JAM output low-level	V _{OL (JAM)}	$I_o = 1\text{ mA}$	—	—	0.2	V
LVA reference voltage	V _{ref (LVA)}		1.18	1.3	1.42	V
LVA hysteresis width	V _{H (LVA)}		50	85	75	mV
LVA output low-level	V _{OL (LVA)}	$I_o = 1\text{ mA}$	—	—	0.2	V

Handling

Handle carefully. IF amplifier features a rather high 100 dB voltage gain with high frequencies.

1. Use as thick a pattern as possible and insert a bypass capacitor between the power source and ground.
2. Install the input and output lines as far from each other as possible, and keep wiring as short as possible.
3. Ground the bypass capacitors of the mixer (pin 22) and IF amplifier (pins 6 and 7) as close as possible to their respective pins.
4. The ground pattern impedance should be as low as possible.

Application Notes

1. Oscillator

The following diagrams show the applications for the CXA1183M oscillator.

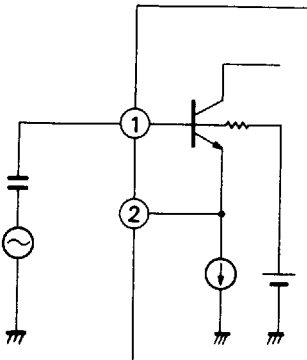

(a) How to input local oscillation signals from an external source.

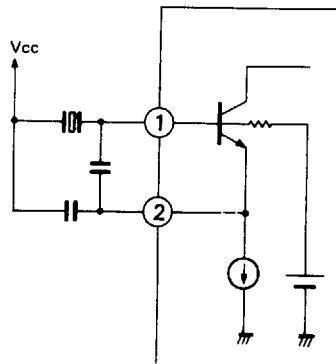

(b) How to form colpitts type oscillation circuits.

2. Mixer

The CXA1183M mixer is of the double balanced type. Pin 24 is the input pin and pin 22 is grounded through a capacitor.

3. 455 kHz filter

A 1.5 kΩ I/O impedance band-pass filter is recommended for CXA1183M.

4. IF amplifier

IF amplifier features a 100 dB high level voltage gain. 455 kHz frequency is mainly used for the IF amplifier AC operation. DC components are cut off by means of Pins 6 and 7 capacitors.

5. QUAD DET

To compose a quadrature FM detector, an RLC parallel resonance circuit or ceramic discriminator is connected to pin 8.

CXA1183M exclusive ceramic discriminator
CDB455C15 (MURATA CO.)

3

6. AF OUT

The audio output pin is connected to an emitter-follower circuit. To employ, cut off DC using a capacitor, and keep a 3 k Ω or larger load resistor.

7. Squelch circuit

The squelch circuit can directly drive a CMOS or a small input current device, as it is connected to V_{cc}, through a 100 k Ω resistance.

The squelch circuit HPF is set to approximately 10 kHz, and the threshold voltage of the comparator is set to approximately 60 mV.

The capacitor and resistor of pin 10 adjust the squelch circuit sensitivity and time constant.

$$R = \frac{V_{ref} \cdot K \cdot R_{in}}{AF \text{ (noise)}} \quad \text{Time constant} \quad T = C \cdot R$$

V _{ref}	60 mV
K	Constant $4\sqrt{2}$
AF (noise)	The noise level at which the squelch operates (peak-to-peak)

The squelch output reverses from high to low as noise increases.

8. LVA (Low Voltage Alarm)

LVA indicates the battery is running out.

V_{ref} is set to approximately 1.3 V (hysteresis is approximately 5%). When the pin 21 voltage drops lower than reference V_{REF} voltage, the output turns from low to high.

LVA can directly drive such a CMOS or a small input current device as it is connected to V_{cc} through a 100 k Ω resistance.

9. RSSI (Receiving Signal Strength Indicator)

RSSI indicates the input signal level. In CXA1183M, a current is output and this output increases in correspondence with the IF input level increase. Current-voltage conversion through a resistance is required for JAMDET use.

10. JAM DET (Jamming detection)

JAM DET is used to detect jamming using the beat component between the jamming and the desired signals. The JAM DET is used when undesired signals interfere in a conversation on a cordless phone or in other FM communications.

11. COMP1

COMP1 is used to stop JAM DET from operating when the electrical signal is weak. As the reference voltage is set to approximately 60 mV, adjust the operation point using an external resistor.

12. COMP2

COMP2 comparator detects the beat component of JAM DET. The reference voltage is set to approximately 60 mV.

13. JAM amplifier

Amplifies the beat components that are between jamming and desired signals. In CXA1183M, as the reference voltage of the comparator used for JAM DET is constant JAM DET sensitivity is set through this JAM amplifier.

14. BPF amplifier

This is the OP amplifier that forms the active filter. It cuts off noise to maintain steady operation of the JAM DET.

15. ABS (Absolute Value Circuit)

ABS is an Absolute Value Circuit that converts the AC output of JAM DET and squelch circuits into DC output.

CXA1183M Output response

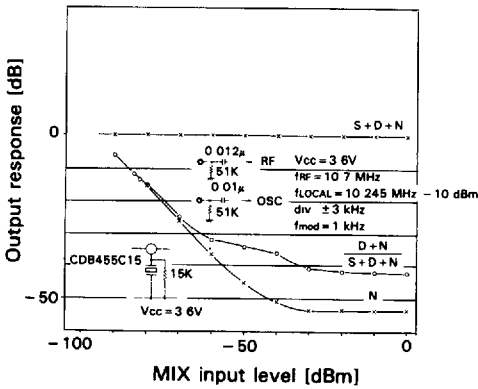



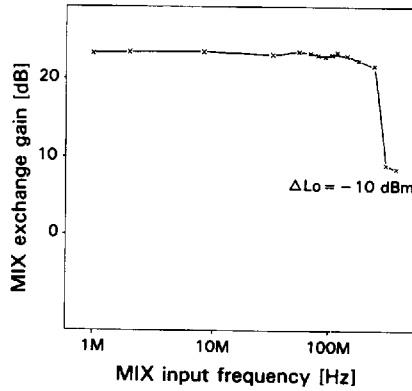











CXA1183M Exchange gain frequency characteristics



3

Package Name

Type	Package name		Package	Features					
	Symbol	Description		Material	Lead pitch	Lead shape	Lead pull out direction		
Inserted	Standard	D I P	DUAL IN-LINE PACKAGE		P C	2.54mm (100MIL)	Through Hole Lead	2-direction	
		S I P	SINGLE IN LINE PACKAGE		P	2.54mm (100MIL)	Through Hole Lead	1-direction	
		Z I P	ZIG ZAG IN-LINE PACKAGE		P	2.54mm (100MIL) Zig-Zag in-line	Through Hole Lead	1-direction	
		P G A	PIN GRID ARRAY		C	2.54mm (100MIL)	Through Hole Lead	Package under side	
		PIGGY BACK	PIGGY BACK		C	2.54mm (100MIL)	Through Hole Lead	2-direction	
	Shrink	SDIP	SHRINK DUAL IN-LINE PACKAGE		P	1.778mm (70MIL)	Through Hole Lead	2-direction	
		SZIP	SHRINK ZIG-ZAG IN-LINE PACKAGE		P	1.778mm (70MIL) Zig-Zag in-line	Through Hole Lead	1-direction	
	Surface mounted	Standard flat package	Q F P	QUAD FLAT L LEADED PACKAGE		P C	1.0mm 0.8mm 0.65mm	Gull-Wing	4-direction
			S O P	SMALL OUTLINE L-LEADED PACKAGE		P	1.27mm (50MIL)	Gull-Wing	2-direction
		Standard 2-direction chip carrier	S O J	SMALL OUTLINE J-LEADED PACKAGE		P	1.27mm (50MIL)	J-Lead	2-direction
Shrink flat package		VQFP	VERY SMALL QUAD FLAT PACKAGE		P	0.5mm	Gull-Wing	4-direction	
		VSOP	VERY SMALL OUTLINE PACKAGE		P	0.65mm	Gull-Wing	2-direction	
		TSOP	THIN SMALL OUTLINE PACKAGE		P	0.5mm (0.55mm)	Gull-Wing	2-direction	
Standard chip carrier		Q F J	QUAD FLAT J-LEADED PACKAGE		P	1.27mm (50MIL)	J-Lead	4-direction	
		Q F N	QUAD FLAT NON-LEADED PACKAGE		C	1.27mm (50MIL)	Leadless	Package under side	

* PPlastic, CCeramic

2