

UTC TL082 LINEAR INTEGRATED CIRCUIT

GENERAL PURPOSE DUAL J-FET OPERATIONAL AMPLIFIER

DESCRIPTION

The UTC TL082 is a high speed J-FET input dual operational amplifier. It incorporates well matched, high voltage J-FET and bipolar transistors in a monolithic integrated circuit.

The device features high slew rates, low input bias and offset current, and low offset voltage temperature coefficient.

FEATURES

- *Low input bias and offset current
- *Wide common-mode (up to V_{CC}^+) and differential voltage range
- *Output short-circuit protection
- *High input impedance J-FET input stage
- *Internal frequency compensation
- *Latch up free operation
- *High slewrate: 16V/ μ s(typ)

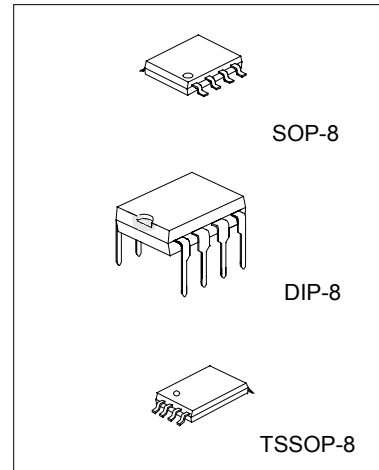

PIN CONFIGURATIONS

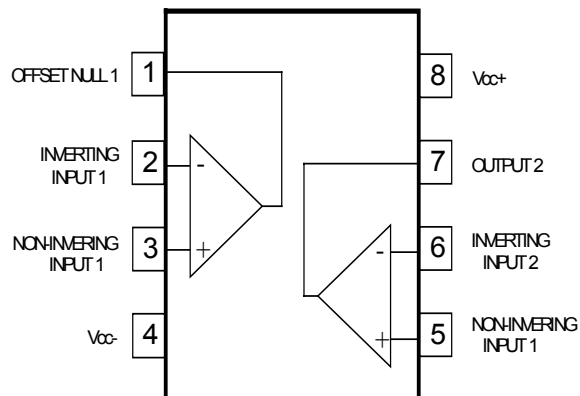

UTC TL082 LINEAR INTEGRATED CIRCUIT

BLOCK DIAGRAM

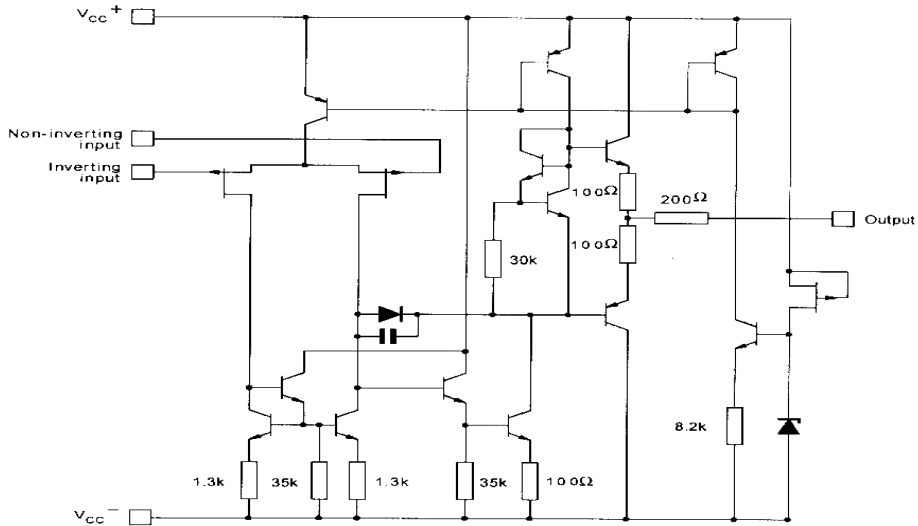

ABSOLUTE MAXIMUM RATINGS (Ta=25°C)

PARAMETER	SYMBOL	VALUE	UNIT
Supply Voltage (note 1)	Vcc	+ -18	V
Input Voltage (note 2)	Vi	+ -15	V
Differential Input Voltage (note 3)	Vid	+ -30	V
Power Dissipation	Ptot	680	mW
Output Short-Circuit Duration (note 4)		Infinite	
Operating Free Air Temperature Range	Toper	0 to 70	°C
Storage Temperature Range	Tstg	-65 to 150	°C

- NOTES:
1. All voltage values, except differential voltage, are with respect to the zero reference level (ground) of the supply voltages where the zero reference level is the midpoint between Vcc and Vcc+.
 2. The magnitude of the input voltage must never exceed the magnitude of the supply voltage or 15 volts, whichever is less.
 3. Differential voltages are at the non-inverting input terminal with respect to the inverting input terminal.
 4. The output may be shorted to ground or to either supply. Temperature and/or supply voltages must be limited to ensure that the dissipation rating is not exceeded.

UTC TL082C ELECTRICAL CHARACTERISTICS

($V_{CC}=\pm 15V$, $T_a=25^{\circ}C$, $T_{min}=0^{\circ}C$, $T_{max}=70^{\circ}C$, unless otherwise specified)

PARAMETER	SYMBOL	MIN	TYP	MAX	UNIT
Input Offset Voltage ($R_s=50\Omega$) $T_a=25^{\circ}C$ $T_{min} \leq T_a \leq T_{max}$	V_{io}		3	10 13	mV
Input Offset Voltage Drift	D_{vio}		10		$\mu V/^{\circ}C$
Input Offset Current * $T_a=25^{\circ}C$ $T_{min} \leq T_a \leq T_{max}$	I_{io}		5	100 10	pA nA
Input Bias Current * $T_a=25^{\circ}C$ $T_{min} \leq T_a \leq T_{max}$	I_{ib}		20	400 20	pA nA
Input Common Mode Voltage Range	V_{icm}	± 11	-12~+15		V
Output Voltage Swing $T_a=25^{\circ}C$, $R_L=2k\Omega$, $T_a=25^{\circ}C$, $R_L=10k\Omega$ $T_{min} \leq T_a \leq T_{max}$, $R_L=2k\Omega$ $T_{min} \leq T_a \leq T_{max}$, $R_L=10k\Omega$	$\pm V_{opp}$	10 12 10 12	12 13.5		V
Large Signal Voltage Gain ($R_L=2k\Omega$, $V_o=\pm 10V$) $T_a=25^{\circ}C$ $T_{min} \leq T_a \leq T_{max}$	A_{vd}	25 15	200		V/mV
Gain Bandwidth Product ($T_a=25^{\circ}C$) $V_{in}=10mV$, $R_L=2k\Omega$, $C_L=100pF$, $f=100kHz$	GBP	2.5	4		MHz
Input Resistance	R_i		10^{12}		Ω
Common Mode Rejection Ratio ($R_s=50\Omega$) $T_a=25^{\circ}C$ $T_{min} \leq T_a \leq T_{max}$	CMR	70 70	86		dB
Supply Voltage Rejection Ratio ($R_s=50\Omega$) $T_a=25^{\circ}C$ $T_{min} \leq T_a \leq T_{max}$	SVR	70 70	86		dB
Supply Current, no load $T_a=25^{\circ}C$ $T_{min} \leq T_a \leq T_{max}$	I_{cc}		1.4	2.5 2.5	mA
Channel Separation ($A_v=100$, $T_a=25^{\circ}C$)	V_{o1}/V_{o2}		120		dB
Output Short-circuit Current $T_a=25^{\circ}C$ $T_{min} \leq T_a \leq T_{max}$	I_{os}	10 10	40	60 60	mA
Slew Rate ($T_a=25^{\circ}C$) $V_i=10V$, $R_L=2k\Omega$, $C_L=100pF$, unity gain	SR	8	16		V/ μs
Rise Time ($T_a=25^{\circ}C$) $V_i=20mV$, $R_L=2k\Omega$, $C_L=100pF$, unity gain	t_r		0.1		μs
Overshoot ($T_a=25^{\circ}C$) $V_i=20mV$, $R_L=2k\Omega$, $C_L=100pF$, unity gain	K_{ov}		10		%
Total Harmonic Distortion ($T_a=25^{\circ}C$) $A_v=20dB$, $f=1kHz$, $R_L=2k\Omega$, $C_L=100pF$, $V_o=2V_{pp}$	THD		0.01		%
Phase Margin	ϕ_m		45		Degrees
Equivalent Input Noise Voltage ($R_s=100\Omega$, $f=1kHz$)	e_n		15		$\frac{nV}{\sqrt{Hz}}$

*The Input bias currents are junction leakage currents, which approximately double for every $10^{\circ}C$ increase in the junction temperature.

UTC TL082AC ELECTRICAL CHARACTERISTICS

(V_{CC}=±15V, T_a=25°C, T_{min}=0°C, T_{max}=70°C, unless otherwise specified)

PARAMETER	SYMBOL	MIN	TYP	MAX	UNIT
Input Offset Voltage (R _s =50Ω) T _a =25°C T _{min} ≤ T _a ≤ T _{max}	V _{io}		3	6 7	mV
Input Offset Voltage Drift	D _{vio}		10		μV/°C
Input Offset Current * T _a =25°C T _{min} ≤ T _a ≤ T _{max}	I _{io}		5	100 4	pA nA
Input Bias Current * T _a =25°C T _{min} ≤ T _a ≤ T _{max}	I _{ib}		20	200 20	pA nA
Input Common Mode Voltage Range	V _{icm}	±11	-12~+15		V
Output Voltage Swing T _a =25°C, R _L =2kΩ, T _a =25°C, R _L =10kΩ T _{min} ≤ T _a ≤ T _{max} , R _L =2kΩ T _{min} ≤ T _a ≤ T _{max} , R _L =10kΩ	±V _{opp}	10 12 10 12	12 13.5		V
Large Signal Voltage Gain (R _L =2kΩ, V _o =±10V) T _a =25°C T _{min} ≤ T _a ≤ T _{max}	A _{vd}	50 25	200		V/mV
Gain Bandwidth Product (T _a =25°C) V _{in} =10mV, R _L =2kΩ, C _L =100pF, f=100kHz	GBP	2.5	4		MHz
Input Resistance	R _i		10 ¹²		Ω
Common Mode Rejection Ratio (R _s =50Ω) T _a =25°C T _{min} ≤ T _a ≤ T _{max}	CMR	80 80	86		dB
Supply Voltage Rejection Ratio (R _s =50Ω) T _a =25°C T _{min} ≤ T _a ≤ T _{max}	SVR	80 80	86		dB
Supply Current, no load T _a =25°C T _{min} ≤ T _a ≤ T _{max}	I _{cc}		1.4	2.5 2.5	mA
Channel Separation (A _v =100, T _a =25°C)	V _{o1} /V _{o2}		120		dB
Output Short-circuit Current T _a =25°C T _{min} ≤ T _a ≤ T _{max}	I _{os}	10 10	40	60 60	mA
Slew Rate (T _a =25°C) V _i =10V, R _L =2kΩ, C _L =100pF, unity gain	SR	8	16		V/μs
Rise Time (T _a =25°C) V _i =20mV, R _L =2kΩ, C _L =100pF, unity gain	t _r		0.1		μs
Overshoot (T _a =25°C) V _i =20mV, R _L =2kΩ, C _L =100pF, unity gain	K _{ov}		10		%
Total Harmonic Distortion (T _a =25°C) A _v =20dB, f=1kHz, R _L =2kΩ, C _L =100pF, V _o =2V _{pp}	THD		0.01		%
Phase Margin	φ _m		45		Degrees
Equivalent Input Noise Voltage (R _s =100Ω, f=1kHz)	e _n		15		$\frac{nV}{\sqrt{Hz}}$

*The Input bias currents are junction leakage currents, which approximately double for every 10°C increase in the junction temperature.

UTC TL082BC ELECTRICAL CHARACTERISTICS

(V_{cc}=±15V, T_a=25°C, T_{min}=0°C, T_{max}=70°C, unless otherwise specified)

PARAMETER	SYMBOL	MIN	TYP	MAX	UNIT
Input Offset Voltage (R _s =50Ω) T _a =25°C T _{min} ≦ T _a ≦ T _{max}	V _{io}		1	3 5	mV
Input Offset Voltage Drift	D _{vio}		10		μV/°C
Input Offset Current * T _a =25°C T _{min} ≦ T _a ≦ T _{max}	I _{io}		5	100 4	pA nA
Input Bias Current * T _a =25°C T _{min} ≦ T _a ≦ T _{max}	I _{ib}		20	200 20	pA nA
Input Common Mode Voltage Range	V _{icm}	±11	-12~+15		V
Output Voltage Swing T _a =25°C, R _L =2kΩ, T _a =25°C, R _L =10kΩ T _{min} ≦ T _a ≦ T _{max} , R _L =2kΩ T _{min} ≦ T _a ≦ T _{max} , R _L =10kΩ	±V _{opp}	10 12 10 12	12 13.5		V
Large Signal Voltage Gain (R _L =2kΩ, V _o =±10V) T _a =25°C T _{min} ≦ T _a ≦ T _{max}	A _{vd}	50 25	200		V/mV
Gain Bandwidth Product (T _a =25°C) V _{in} =10mV, R _L =2kΩ, C _L =100pF, f=100kHz	GBP	2.5	4		MHz
Input Resistance	R _i		10 ¹²		Ω
Common Mode Rejection Ratio (R _s =50Ω) T _a =25°C T _{min} ≦ T _a ≦ T _{max}	CMR	80 80	86		dB
Supply Voltage Rejection Ratio (R _s =50Ω) T _a =25°C T _{min} ≦ T _a ≦ T _{max}	SVR	80 80	86		dB
Supply Current, no load T _a =25°C T _{min} ≦ T _a ≦ T _{max}	I _{cc}		2.4	3.5 2.5	mA
Channel Separation (A _v =100, T _a =25°C)	V _{o1} /V _{o2}		120		dB
Output Short-circuit Current T _a =25°C T _{min} ≦ T _a ≦ T _{max}	I _{os}	10 10	40	60 60	mA
Slew Rate (T _a =25°C) V _i =10V, R _L =2kΩ, C _L =100pF, unity gain	SR	8	16		V/μs
Rise Time (T _a =25°C) V _i =20mV, R _L =2kΩ, C _L =100pF, unity gain	t _r		0.1		μs
Overshoot (T _a =25°C) V _i =20mV, R _L =2kΩ, C _L =100pF, unity gain	K _{ov}		10		%
Total Harmonic Distortion (T _a =25°C) A _v =20dB, f=1kHz, R _L =2kΩ, C _L =100pF, V _o =2V _{pp}	THD		0.01		%
Phase Margin	φ _m		45		Degrees
Equivalent Input Noise Voltage (R _s =100Ω, f=1KHz)	e _n		15		$\frac{nV}{\sqrt{Hz}}$

*The Input bias currents are junction leakage currents, which approximately double for every 10°C increase in the junction temperature.

MAXIMUM PEAK-TO-PEAK OUTPUT VOLTAGE VERSUS FREQUENCY

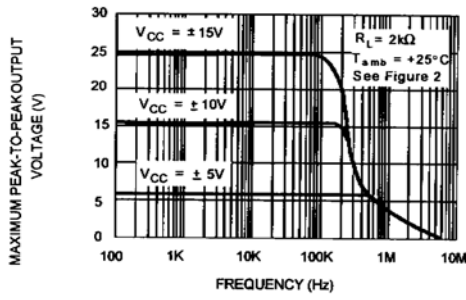

MAXIMUM PEAK-TO-PEAK OUTPUT VOLTAGE VERSUS FREQUENCY

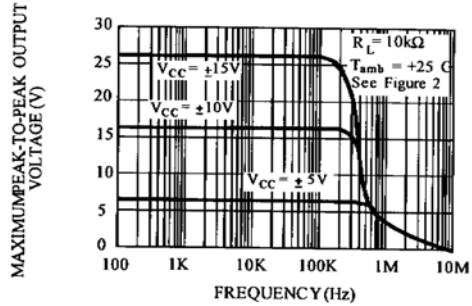

MAXIMUM PEAK-TO-PEAK OUTPUT VOLTAGE VERSUS FREE AIR TEMP.

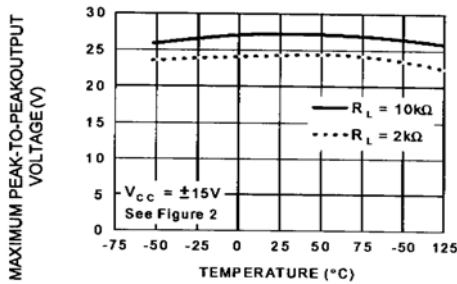

MAXIMUM PEAK-TO-PEAK OUTPUT VOLTAGE VERSUS LOAD RESISTANCE

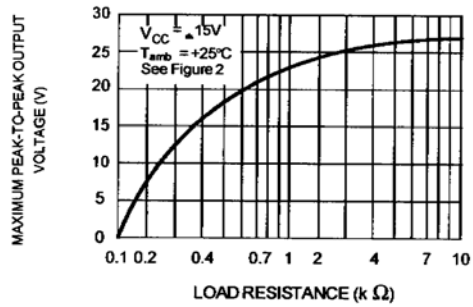

MAXIMUM PEAK-TO-PEAK OUTPUT VOLTAGE VERSUS SUPPLY VOLTAGE

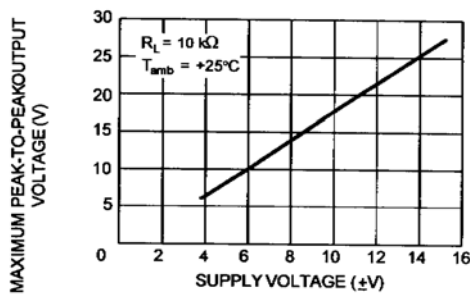

INPUT BIAS CURRENT VERSUS FREE AIR TEMPERATURE

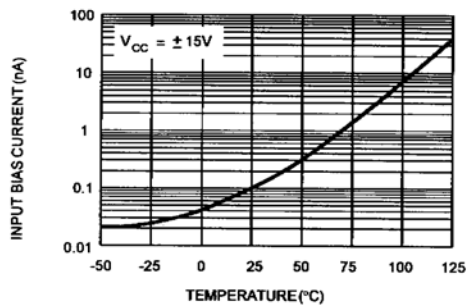

LARGE SIGNAL DIFFERENTIAL VOLTAGE AMPLIFICATION VERSUS FREE AIR TEMPERATURE

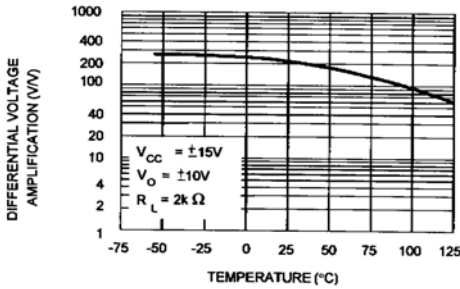

TOTAL POWER DISSIPATION VERSUS FREE AIR TEMPERATURE

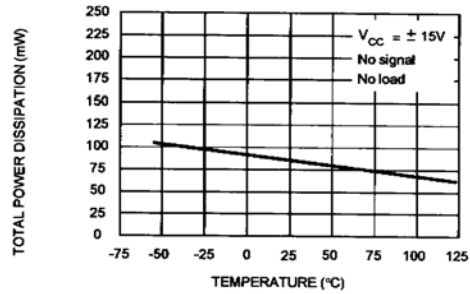

SUPPLY CURRENT PER AMPLIFIER VERSUS FREE AIR TEMPERATURE

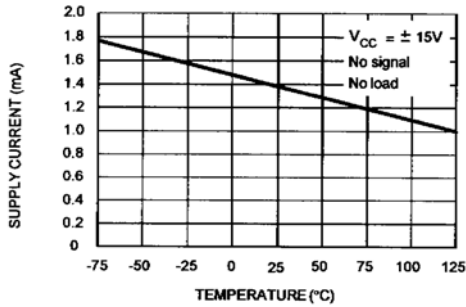

COMMON MODE REJECTION RATIO VERSUS FREE AIR TEMPERATURE

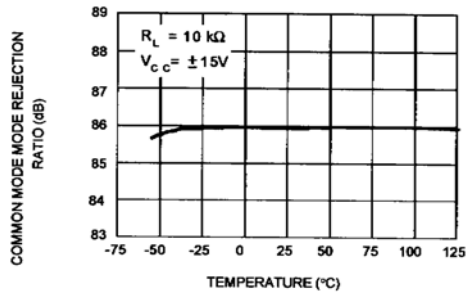

SUPPLY CURRENT PER AMPLIFIER versus SUPPLY VOLTAGE

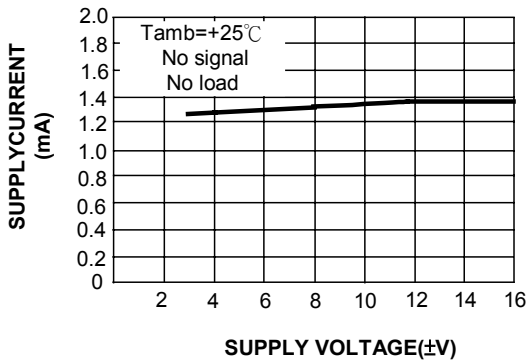

TOTAL HARMONIC DISTORTION versus FREQUENCY

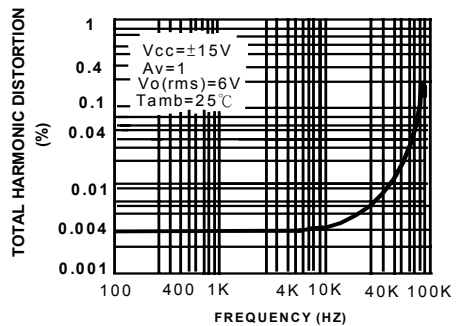

UTC TL082 LINEAR INTEGRATED CIRCUIT

VOLTAGE FOLLOWER LARGE SIGNAL PULSE RESPONSE

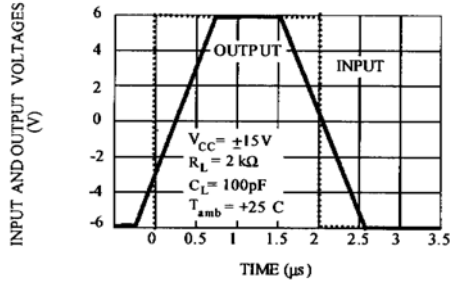

OUTPUT VOLTAGE VERSUS ELAPSED TIME

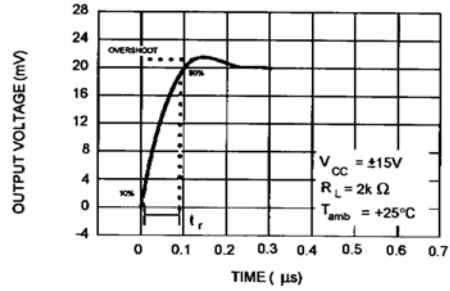

EQUIVALENT INPUT NOISE VOLTAGE VERSUS FREQUENCY

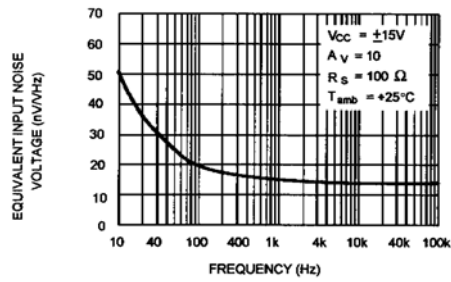

PARAMETER MEASUREMENT INFORMATION

Figure 1: Voltage Follower

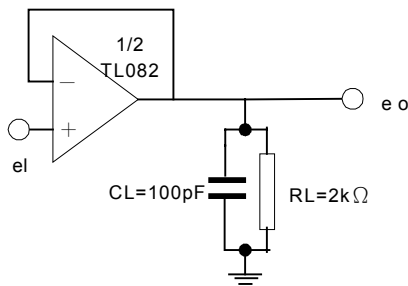
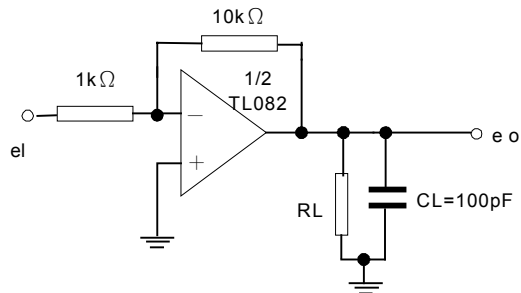

Figure 2: Gain-of-10 Inverting Amplifier



UTC TL082 LINEAR INTEGRATED CIRCUIT

TYPICAL APPLICATIONS

100KHZ QUADRUPLE OSCILLATOR

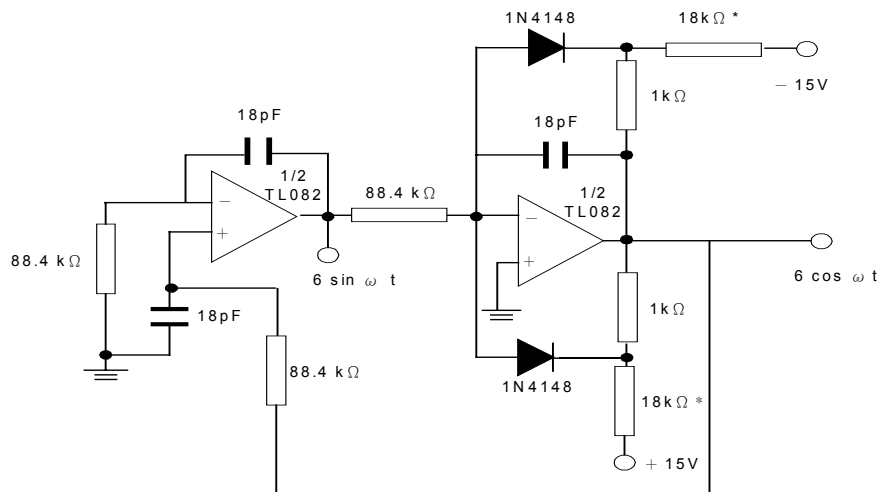

*These resistors values may be adjusted for a symmetrical output

UTC assumes no responsibility for equipment failures that result from using products at values that exceed, even momentarily, rated values (such as maximum ratings, operating condition ranges, or other parameters) listed in products specifications of any and all UTC products described or contained herein. UTC products are not designed for use in life support appliances, devices or systems where malfunction of these products can be reasonably expected to result in personal injury. Reproduction in whole or in part is prohibited without the prior written consent of the copyright owner. The information presented in this document does not form part of any quotation or contract, is believed to be accurate and reliable and may be changed without notice.