

Features

- Very Low Forward Voltage Drop
- Guard Ring Construction for Transient Protection
- High Conductance
- **Lead Free By Design/RoHS Compliant (Note 4)**
- **"Green Device" (Note 5)**

Mechanical Data

- Case: SOT-23
- Case Material: Molded Plastic. UL Flammability Classification Rating 94V-0
- Moisture Sensitivity: Level 1 per J-STD-020C
- Polarity: See Diagram
- Leads: Solderable per MIL-STD-202, Method 208
- Terminals: SDM40E20LS Finish — Matte Tin Finish annealed over Alloy 42 leadframe.
SDM40E20LC Finish — Matte Tin Finish annealed over CDA194 leadframe. Solderable per MIL-STD-202, Method 208
- Marking: Date Code and Type Code
- Type Code: KSW, KWS
- Ordering Information: See Page 3
- Weight: 0.008 grams (approximate)

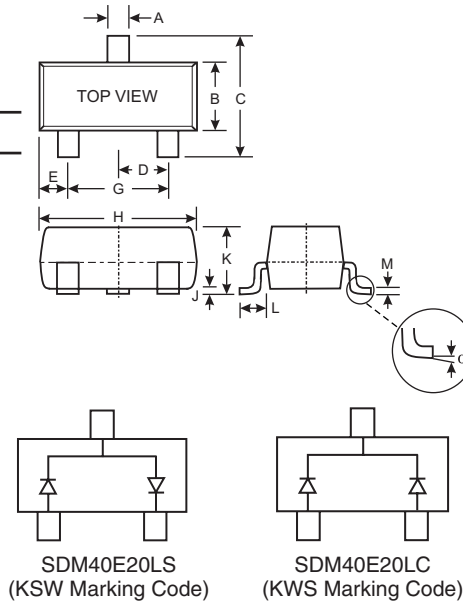

| SOT-23 | | |
|----------------------|-------|-------|
| Dim | Min | Max |
| A | 0.37 | 0.51 |
| B | 1.20 | 1.40 |
| C | 2.30 | 2.50 |
| D | 0.89 | 1.03 |
| E | 0.45 | 0.60 |
| G | 1.78 | 2.05 |
| H | 2.80 | 3.00 |
| J | 0.013 | 0.10 |
| K | 0.903 | 1.10 |
| L | 0.45 | 0.61 |
| M | 0.085 | 0.180 |
| α | 0° | 8° |
| All Dimensions in mm | | |

Maximum Ratings @ $T_A = 25^\circ\text{C}$ unless otherwise specified

Single phase, half wave, 60Hz, resistive or inductive load.
For capacitive load, derate current by 20%.

| Characteristic | Symbol | Value | Unit |
|---|---------------------------------|-------------|--------------------|
| Peak Repetitive Reverse Voltage Working Peak Reverse Voltage DC Blocking Voltage | V_{RRM} V_{RWM} V_R | 20 | V |
| RMS Reverse Voltage | $V_{R(RMS)}$ | 14 | V |
| Forward Continuous Current (Note 1) | I_{FM} | 0.4 | A |
| Non-Repetitive Peak Forward Surge Current 8.3ms single half sine-wave superimposed on rated load | I_{FSM} | 2 | A |
| Power Dissipation (Note 1) (Note 2) | P_d | 225 300 | mW |
| Typical Thermal Resistance Junction to Ambient (Note 1) (Note 2) | $R_{\theta JA}$ | 444 333 | $^\circ\text{C/W}$ |
| Operating and Storage Temperature Range | T_j, T_{STG} | -65 to +125 | $^\circ\text{C}$ |

Electrical Characteristics @ $T_A = 25^\circ\text{C}$ unless otherwise specified

| Characteristic | Symbol | Min | Typ | Max | Unit | Test Conditions |
|------------------------------------|-------------|-----|-----|----------------|---------------|--|
| Reverse Breakdown Voltage (Note 3) | $V_{(BR)R}$ | 20 | — | — | V | $I_R = 0.5\text{mA}$ |
| Forward Voltage Drop | V_F | — | — | 0.310 0.430 | V | $I_F = 0.1\text{A}$ $I_F = 0.5\text{A}$ |
| Leakage Current (Note 3) | I_R | — | — | 100 250 | μA | $V_R = 10\text{V}$ $V_R = 20\text{V}$ |
| Total Capacitance | C_T | — | 120 | — | pF | $f = 1\text{MHz}, V_R = 0\text{VDC}$ |

- Notes:
1. Device mounted on FR-5 1.0 x 0.75 x 0.062 inch PCB pad layout.
 2. Device mounted on Alumina PCB, 0.4 inch x 0.3 inch x 0.024 inch pad layout.
 3. Short duration test pulse used to minimize self-heating effect.
 4. No purposefully added lead.
 5. Diodes Inc.'s "Green" policy can be found on our website at http://www.diodes.com/products/lead_free/index.php.

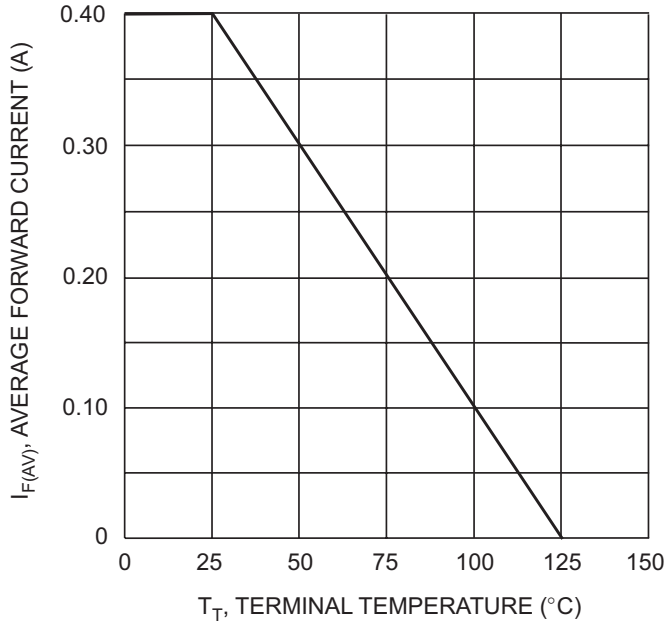

Fig. 1 Forward Current Derating Curve, Per Element

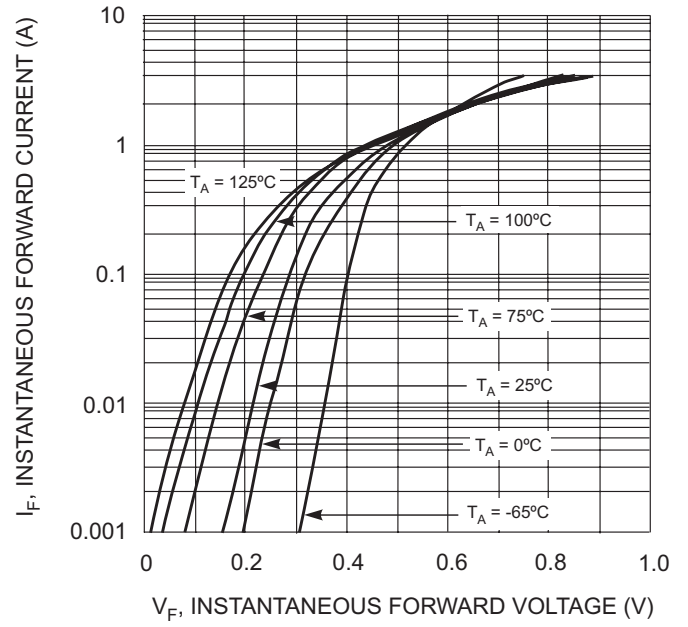

Fig. 2 Typical Forward Characteristics, Per Element

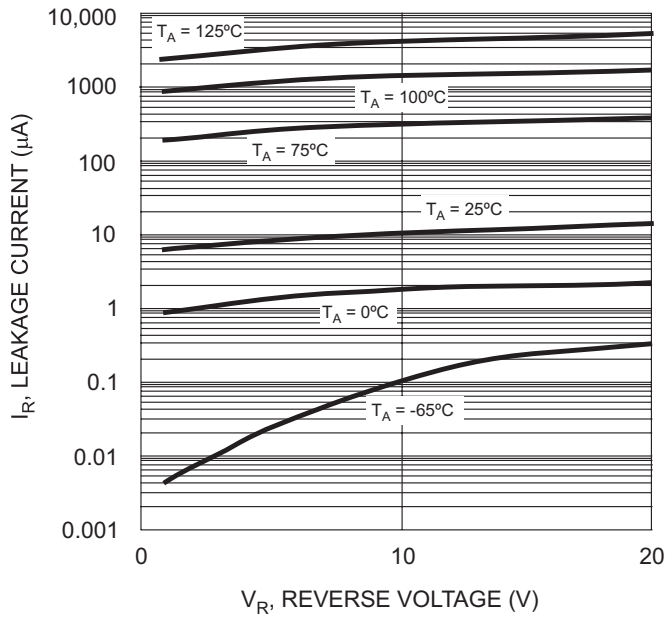

Fig. 3 Typical Reverse Characteristics, Per Element

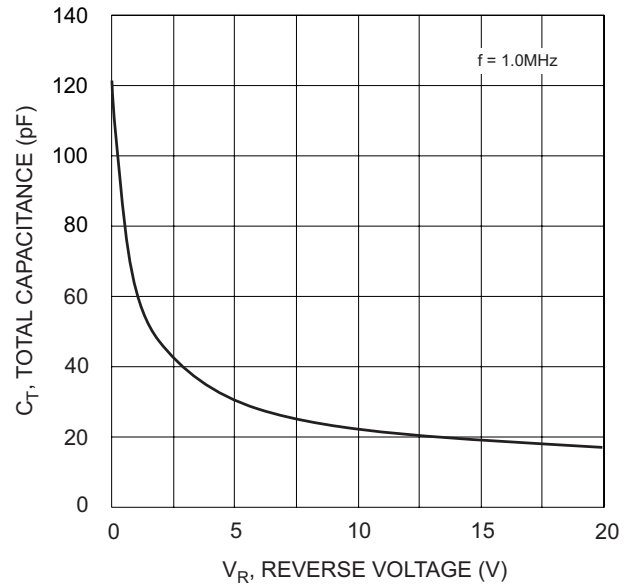

Fig. 4 Typ. Total Capacitance vs Reverse Voltage, Per Element

Ordering Information (Note 6)

| Device | Packaging | Shipping |
|--------------|-----------|------------------|
| SDM40E20LS-7 | SOT-23 | 3000/Tape & Reel |
| SDM40E20LC-7 | SOT-23 | 3000/Tape & Reel |

Notes: 6. For Packaging Details, go to our website at <http://www.diodes.com/datasheets/ap02007.pdf>.

Marking Information

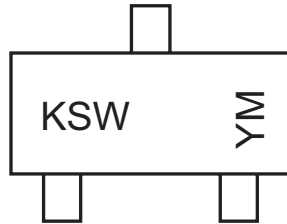

KSW = SDM40E20LS Product Type
Marking Code
YM = Date Code Marking
Y = Year ex: T = 2006
M = Month ex: 9 = September

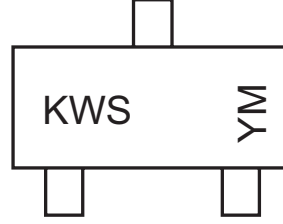

KWS = SDM40E20LC Product Type
Marking Code
YM = Date Code Marking
Y = Year ex: T = 2006
M = Month ex: 9 = September

Date Code Key

| Year | 2005 | 2006 | 2007 | 2008 | 2009 | 2010 | 2011 | 2012 |
|------|------|------|------|------|------|------|------|------|
| Code | S | T | U | V | W | X | Y | Z |

| Month | Jan | Feb | Mar | Apr | May | Jun | Jul | Aug | Sep | Oct | Nov | Dec |
|-------|-----|-----|-----|-----|-----|-----|-----|-----|-----|-----|-----|-----|
| Code | 1 | 2 | 3 | 4 | 5 | 6 | 7 | 8 | 9 | O | N | D |

IMPORTANT NOTICE

Diodes Incorporated and its subsidiaries reserve the right to make modifications, enhancements, improvements, corrections or other changes without further notice to any product herein. Diodes Incorporated does not assume any liability arising out of the application or use of any product described herein; neither does it convey any license under its patent rights, nor the rights of others. The user of products in such applications shall assume all risks of such use and will agree to hold Diodes Incorporated and all the companies whose products are represented on our website, harmless against all damages.

LIFE SUPPORT

Diodes Incorporated products are not authorized for use as critical components in life support devices or systems without the expressed written approval of the President of Diodes Incorporated.