

MAU200 Series

1W, High Isolation SIP, Single & Dual Output DC/DC Converters

Key Features

- Efficiency up to 81%
- 3000VDC Isolation
- MTBF > 2,000,000 Hours
- Low Cost
- Input 5, 12 and 24VDC
- Output 3.3, 5, 9, 12, 15, ± 5 , ± 9 , ± 12 and ± 15 VDC
- Temperature Performance -40°C to $+85^{\circ}\text{C}$
- UL 94V-0 Package Material
- Internal SMD Construction
- Industry Standard Pinout

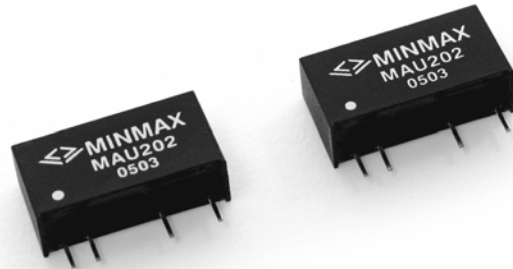

Minmax's MAU200 1W DC/DC's are specially designed to provide high levels of isolation 3000VDC in a miniature SIP package.

The series consists of 27 models with input voltages of 5V, 12V and 24VDC which offers standard output voltages of 3.3V, 5V, 9V, 12V, 15V, ± 5 V, ± 9 V, ± 12 V and ± 15 VDC for a wide choice.

The MAU200 series is an excellent selection for a variety of applications including distributed power systems, mixed analog/digital subsystems, portable test equipments, local power networks and battery backed systems.

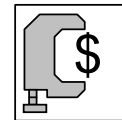

Low Cost

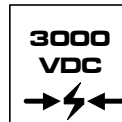

I/O Isolation

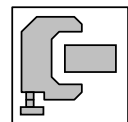

Low Profile

Block Diagram

Single Output

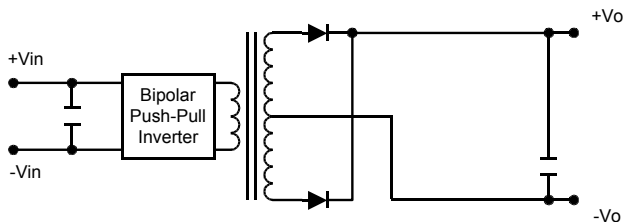

Dual Output

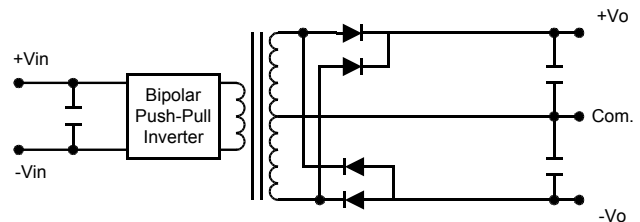

Model Selection Guide

Model Number	Input Voltage	Output Voltage	Output Current		Input Current		Load Regulation	Efficiency
			Max.	Min.	@Max. Load	@No Load		
	VDC	VDC	mA	mA	mA (Typ.)	mA (Typ.)	% (Max.)	% (Typ.)
MAU201	5 (4.5 ~ 5.5)	3.3	260	5	235	30	10	73
MAU202		5	200	4	281		10	71
MAU203		9	110	2	260		8	76
MAU204		12	84	1.5	258		7	78
MAU205		15	67	1	258		7	78
MAU206		±5	±100	±2	278		10	72
MAU207		±9	±56	±1	262		8	77
MAU208		±12	±42	±0.8	258		7	78
MAU209		±15	±34	±0.7	258		7	79
MAU211	12 (10.8 ~ 13.2)	3.3	260	5	96	12	8	74
MAU212		5	200	4	114		8	73
MAU213		9	110	2	106		5	78
MAU214		12	84	1.5	105		5	80
MAU215		15	67	1	104		5	80
MAU216		±5	±100	±2	113		8	74
MAU217		±9	±56	±1	106		5	79
MAU218		±12	±42	±0.8	104		5	81
MAU219		±15	±34	±0.7	105		5	81
MAU221	24 (21.6 ~ 26.4)	3.3	260	5	49	7	8	73
MAU222		5	200	4	59		8	71
MAU223		9	110	2	54		5	76
MAU224		12	84	1.5	54		5	78
MAU225		15	67	1	53		5	79
MAU226		±5	±100	±2	58		8	72
MAU227		±9	±56	±1	55		5	76
MAU228		±12	±42	±0.8	53		5	79
MAU229		±15	±34	±0.7	53		5	80

Absolute Maximum Ratings

Parameter	Min.	Max.	Unit	
Input Surge Voltage (1000 mS)	5VDC Input Models	-0.7	9	VDC
	12VDC Input Models	-0.7	18	VDC
	24VDC Input Models	-0.7	30	VDC
Lead Temperature (1.5mm from case for 10 Sec.)	---	260	°C	
Internal Power Dissipation	---	450	mW	

Exceeding the absolute maximum ratings of the unit could cause damage.
These are not continuous operating ratings.

Environmental Specifications

Parameter	Conditions	Min.	Max.	Unit
Operating Temperature	Ambient	-40	+85	°C
Operating Temperature	Case	-40	+90	°C
Storage Temperature		-40	+125	°C
Humidity		---	95	%
Cooling	Free-Air Convection			

Notes :

- Specifications typical at $T_a = +25^\circ\text{C}$, resistive load, nominal input voltage, rated output current unless otherwise noted.
- Ripple & Noise measurement bandwidth is 0-20 MHz.
- These power converters require a minimum output loading to maintain specified regulation.
- Operation under no-load conditions will not damage these modules; however, they may not meet all specifications listed.
- All DC/DC converters should be externally fused at the front end for protection.
- Other input and output voltage may be available, please contact factory.
- Specifications subject to change without notice.

Input Specifications

Parameter	Model	Min.	Typ.	Max.	Unit
Input Voltage Range	5V Input Models	4.5	5	5.5	VDC
	12V Input Models	10.8	12	13.2	
	24V Input Models	21.6	24	26.4	
Reverse Polarity Input Current	All Models	---	---	0.3	A
Input Filter		Internal Capacitor			

Output Specifications

Parameter	Conditions	Min.	Typ.	Max.	Unit
Output Voltage Accuracy		---	± 1.0	± 3.0	%
Output Voltage Balance	Dual Output, Balanced Loads	---	± 0.1	± 1.0	%
Line Regulation	For V_{in} Change of 1%	---	± 1.2	± 1.5	%
Load Regulation	$I_o=20\%$ to 100%	See Model Selection Guide			%
Ripple & Noise (20MHz)		---	65	100	mV P-P
Ripple & Noise (20MHz)	Over Line, Load & Temp.	---	---	150	mV P-P
Ripple & Noise (20MHz)		---	---	5	mV rms
Over Load		120	---	---	%
Temperature Coefficient		---	± 0.01	± 0.02	%/°C
Output Short Circuit	0.5 Second Max.				

General Specifications

Parameter	Conditions	Min.	Typ.	Max.	Unit
Isolation Voltage Rated	60 Seconds	3000	---	---	VDC
Isolation Voltage Test	Flash Tested for 1 Second	3300	---	---	VDC
Isolation Resistance	500VDC	10	---	---	GΩ
Isolation Capacitance	100KHz, 1V	---	60	100	pF
Switching Frequency		70	100	120	KHz
MTBF	MIL-HDBK-217F @ 25°C, Ground Benign	2000	---	---	K Hours

Capacitive Load

Models by Vout	3.3V	5V	9V	12V	15V	±5V #	±9V #	±12V #	±15V #	Unit
Maximum Capacitive Load	220	220	220	220	220	100	100	100	100	uF

For each output

Input Fuse Selection Guide

5V Input Models	12V Input Models	24V Input Models
500mA Slow – Blow Type	200mA Slow – Blow Type	100mA Slow – Blow Type

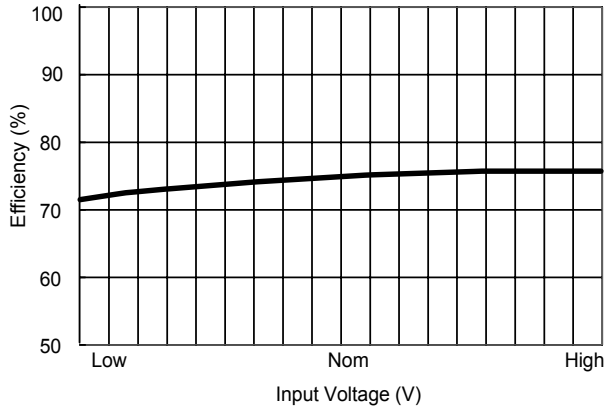

Efficiency vs Input Voltage (Single Output)

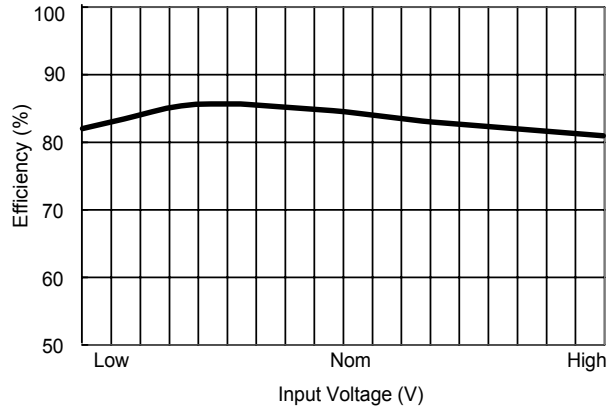

Efficiency vs Input Voltage (Dual Output)

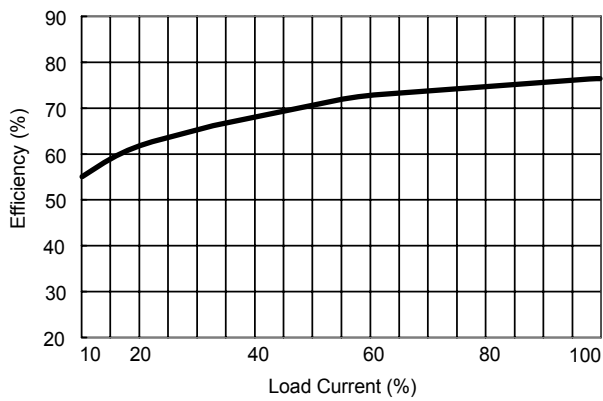

Efficiency vs Output Load (Single Output)

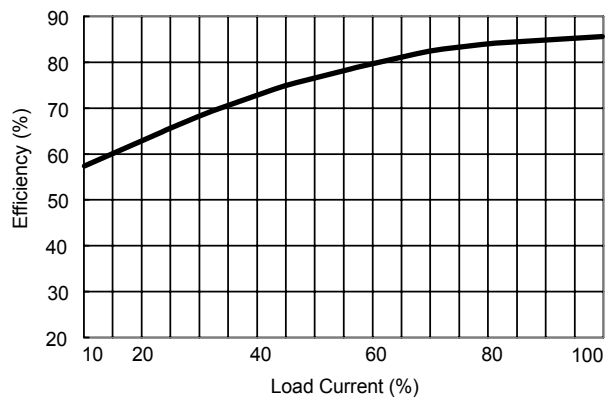

Efficiency vs Output Load (Dual Output)

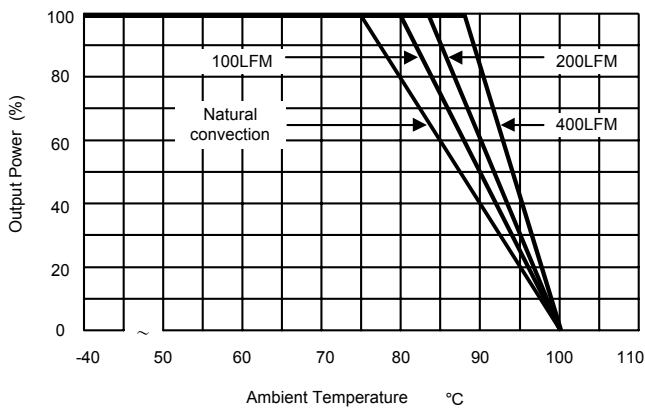

Derating Curve (3.3V, 5V & ±5V)

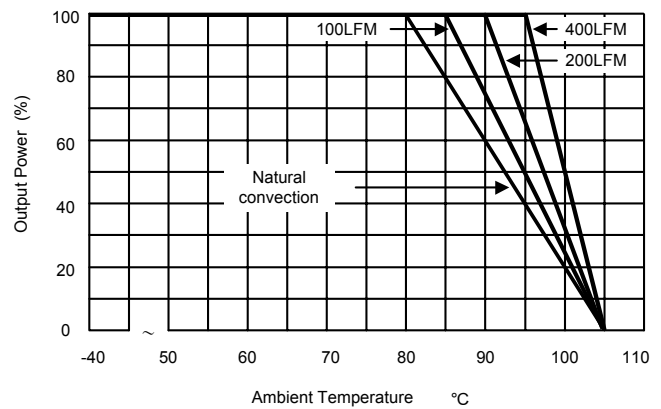

Derating Curve (all other output)

Test Configurations

Input Reflected-Ripple Current Test Setup

Input reflected-ripple current is measured with an inductor L_{in} (4.7uH) and C_{in} (220uF, ESR < 1.0Ω at 100 KHz) to simulate source impedance.

Capacitor C_{in} , offsets possible battery impedance.

Current ripple is measured at the input terminals of the module, measurement bandwidth is 0–500 KHz.

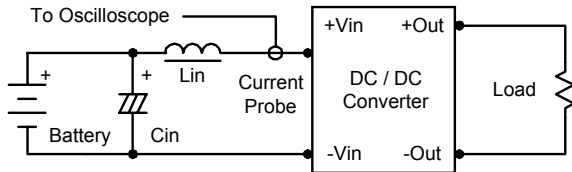

Peak-to-Peak Output Noise Measurement Test

Use a C_{out} 0.33uF ceramic capacitor.

Scope measurement should be made by using a BNC socket, measurement bandwidth is 0–20 MHz. Position the load between 50 mm and 75 mm from the DC/DC Converter.

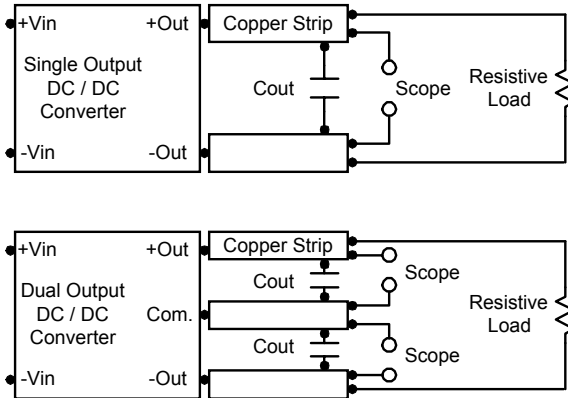

Design & Feature Considerations

Maximum Capacitive Load

The MAU200 series has limitation of maximum connected capacitance at the output.

The power module may be operated in current limiting mode during start-up, affecting the ramp-up and the startup time.

For optimum performance we recommend 100uF maximum capacitive load for dual outputs and 220uF capacitive load for single outputs.

The maximum capacitance can be found in the data sheet.

Input Source Impedance

The power module should be connected to a low ac-impedance input source. Highly inductive source impedances can affect the stability of the power module.

In applications where power is supplied over long lines and output loading is high, it may be necessary to use a capacitor at the input to ensure startup.

Capacitor mounted close to the power module helps ensure stability of the unit, it is recommended to use a good quality low Equivalent Series Resistance (ESR < 1.0Ω at 100 KHz) capacitor of a 2.2uF for the 5V input devices, a 1.0uF for the 12V input devices and a 0.47uF for the 24V devices.

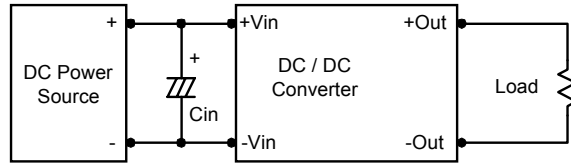

Output Ripple Reduction

A good quality low ESR capacitor placed as close as practicable across the load will give the best ripple and noise performance.

To reduce output ripple, it is recommended to use 1.0uF capacitors at the output.

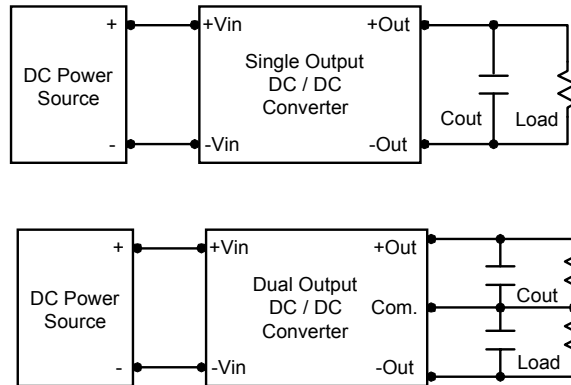

Thermal Considerations

Many conditions affect the thermal performance of the power module, such as orientation, airflow over the module and board spacing. To avoid exceeding the maximum temperature rating of the components inside the power module, the case temperature must be kept below 90°C.

The derating curves are determined from measurements obtained in an experimental apparatus.

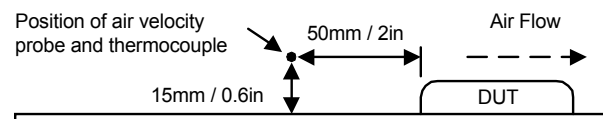

Mechanical Dimensions

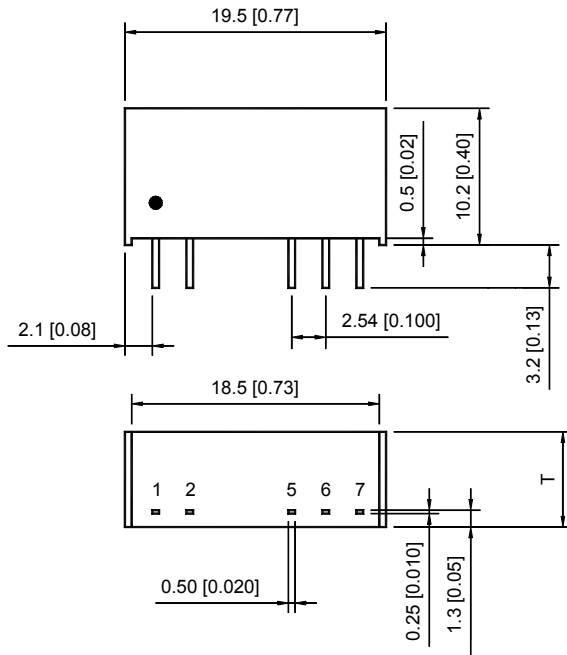

T: 6.1(0.24) for 5V&12V Input Models

T: 7.1(0.28) for 24V Input Models

Tolerance	Millimeters	Inches
	X.X±0.25	X.XX±0.01
	X.XX±0.13	X.XXX±0.005
Pin	±0.05	±0.002

Connecting Pin Patterns

Top View (2.54 mm / 0.1 inch grids)

Single Output

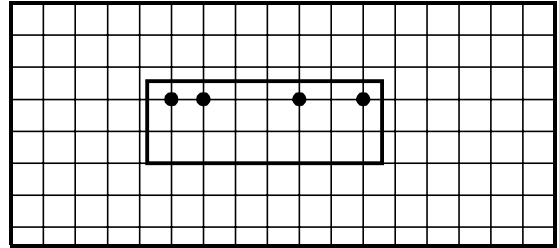

Dual Output

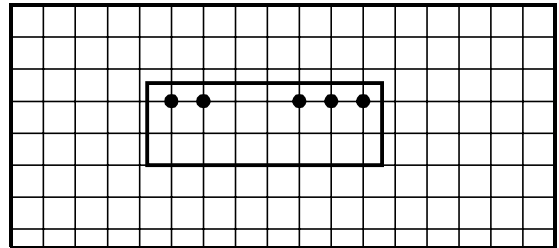

Pin Connections

Pin	Single Output	Dual Output
1	+Vin	+Vin
2	-Vin	-Vin
5	-Vout	-Vout
6	No Pin	Common
7	+Vout	+Vout

Physical Characteristics

Case Size : 19.5×6.1×10.2 mm
(5 & 12V Input) : 0.77×0.24×0.40 inches

Case Size : 19.5×7.1×10.2 mm
(24V Input) : 0.77×0.28×0.40 inches

Case Material : Non-Conductive Black Plastic

Weight : 2.2g (5 & 12V Input)
2.6g (24V Input)

The MAU200 converter is encapsulated in a low thermal resistance molding compound that has excellent resistance/electrical characteristics over a wide temperature range or in high humidity environments.

The encapsulant and unit case are both rated to UL 94V-0 flammability specifications.

Leads are tin plated for improved solderability.